

Foscarini

TECNICO — 2023

Indoor: Tavolo,
Terra, Sospensione,
Soffitto, Parete;
Outdoor.

Tecnico — 2023
/ 220V Eur

Valid from
1st January 2023



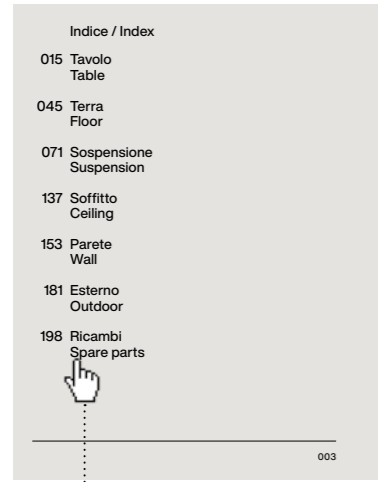

Click to view the category index

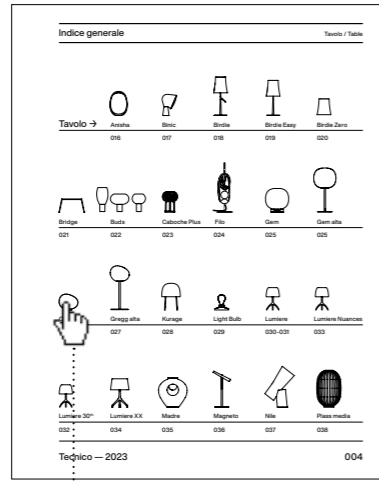

Click on the image to open the detail page

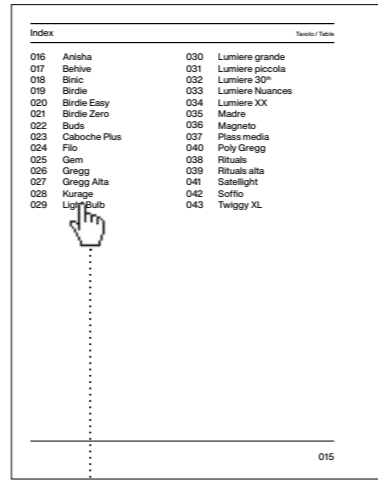

Click on the product name to open the detail page

015 Tavolo
Table

045 Terra
Floor

071 Sospensione
Suspension

137 Soffitto
Ceiling

153 Parete
Wall







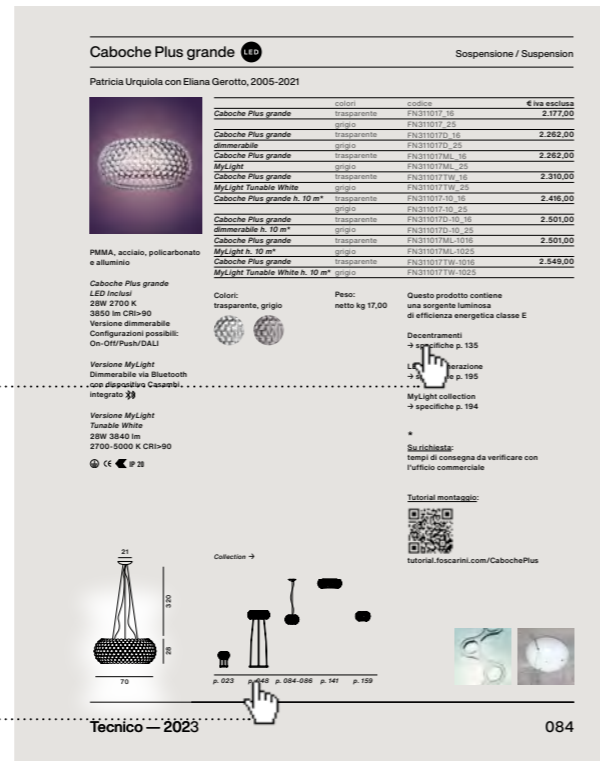









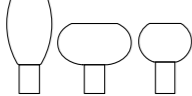

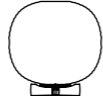
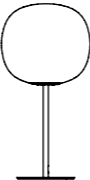
181 Esterno
Outdoor

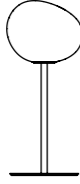
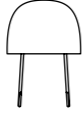



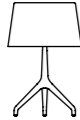
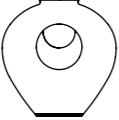







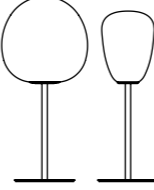
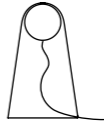



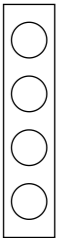

198 Ricambi
Spare parts

Click to view the category page

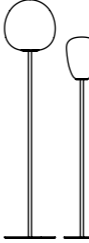

Click on the drawings to learn more about the products of the same family

Tavolo →						
	Anisha	Binic	Birdie	Birdie Easy	Birdie Zero	
	016	017	018	019	020	
						
	Bridge	Buds	Caboche Plus	Filo	Gem	Gem alta
	021	022	023	024	025	025
						
	Gregg	Gregg alta	Kurage	Light Bulb	Lumiere	Lumiere Nuances
	026	027	028	029	030-031	033
						
	Lumiere 30 th	Lumiere XX	Madre	Magneto	Nile	Plass media
	032	034	035	036	037	038

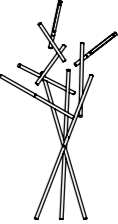
Terra →						
	Poly Gregg	Rituals	Rituals alta	Satellight	Soffio	
	039	040	041	042	043	
						
		Birdie	Birdie Easy	Caboche Plus	Chiaroscura	Dolmen
		046	047	048	049	050
						
	Filo	Gem	Gregg	Havana	Lumiere XXL	Magneto
	051	052	053	054	055	056
						
	Mite	Orbital	Rituals	Tobia	Tress	Tuareg
	057	058	059	060	061	062

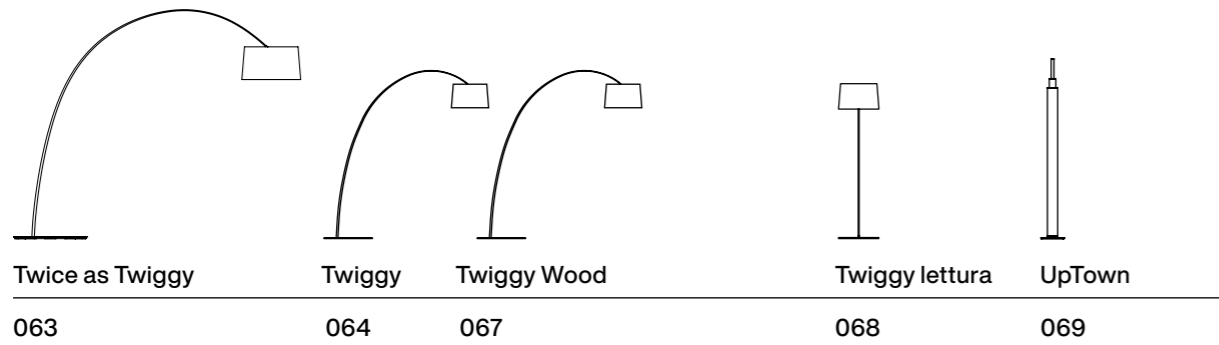

Twice as Twiggy 063 Twiggy 064 Twiggy Wood 067 Twiggy lettura 068 UpTown 069

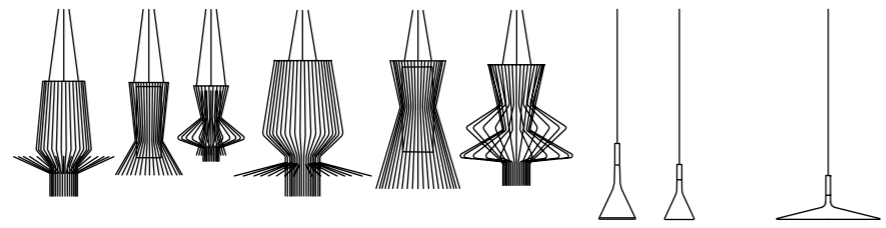

Sospensione →

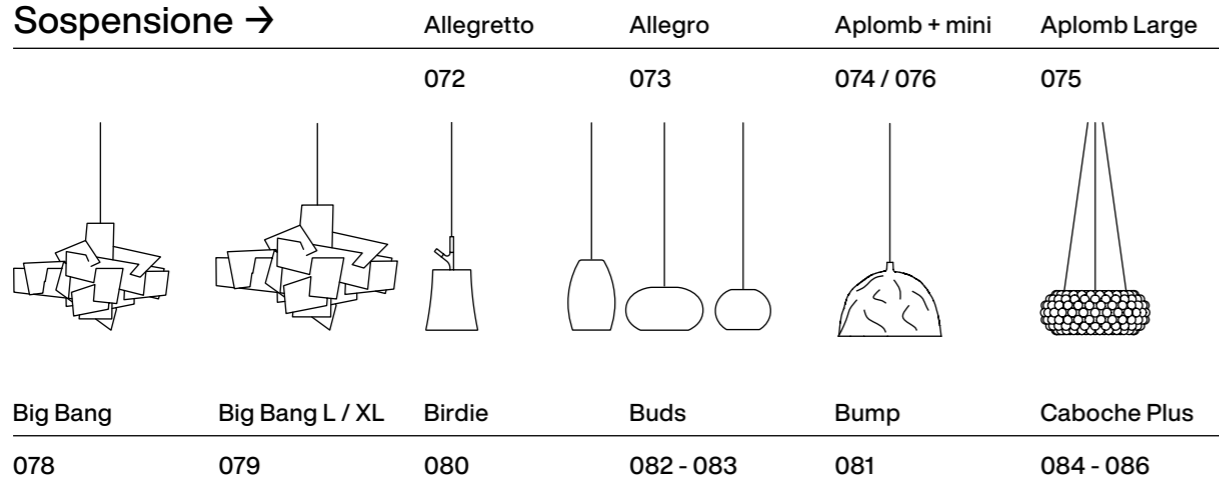

Allegretto 072 Allegro 073 Aplomb + mini 074 / 076 Aplomb Large 075

Big Bang 078 Big Bang L / XL 079 Birdie 080 Buds 082 - 083 Bump 081 Caboché Plus 084 - 086

Chouchin 088 - 089 Chouchin Reverse 090 - 091 Dolmen 092 Gem 093 Giga-Lite 096

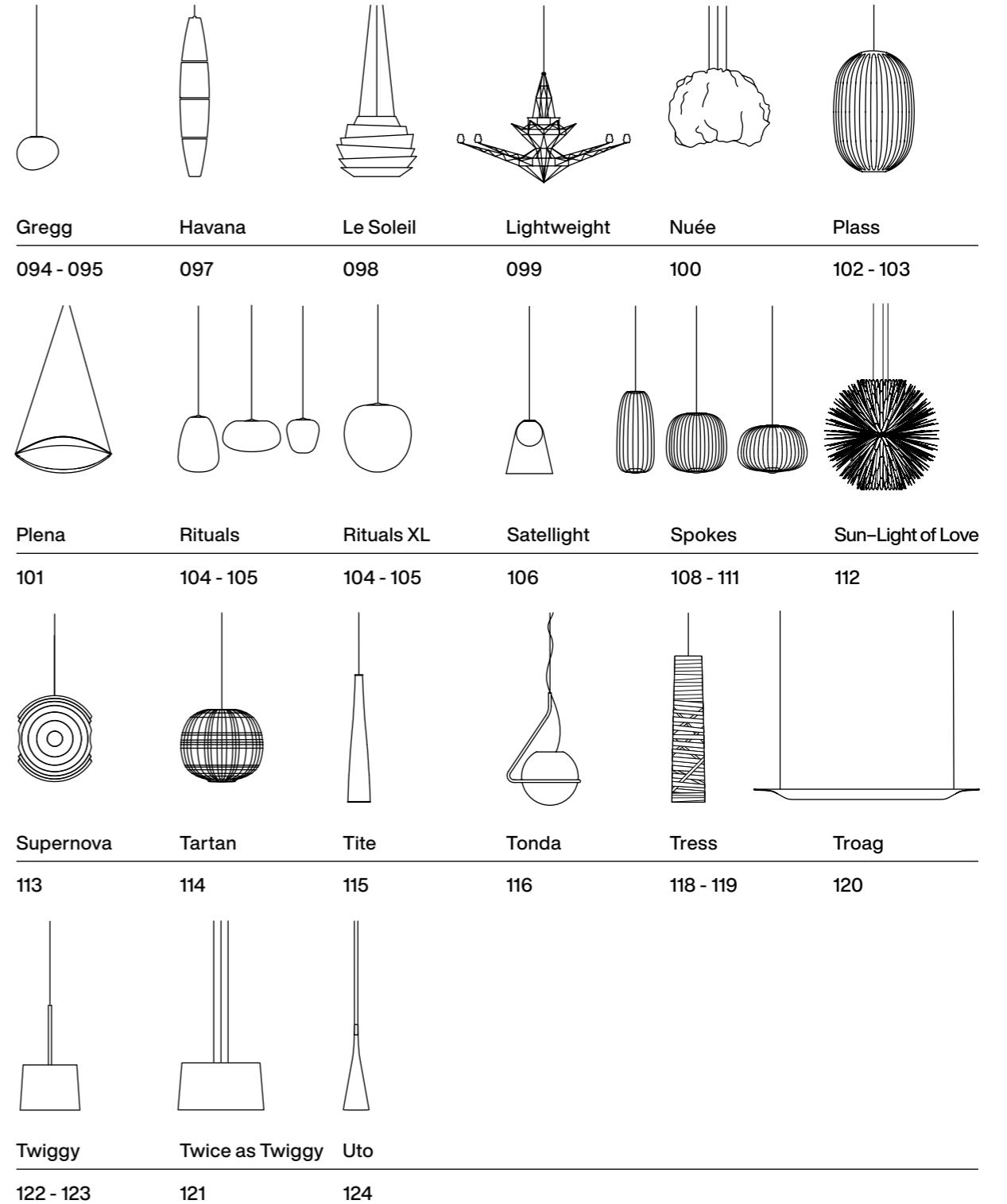

Gregg 094 - 095 Havana 097 Le Soleil 098 Lightweight 099 Nuée 100 Plass 102 - 103

Plena 101 Rituals 104 - 105 Rituals XL 104 - 105 Satellight 106 Spokes 108 - 111 Sun-Light of Love 112

Supernova 113 Tartan 114 Tite 115 Tonda 116 Tress 118 - 119 Troag 120

Twiggy 122 - 123 Twice as Twiggy 121 Uto 124

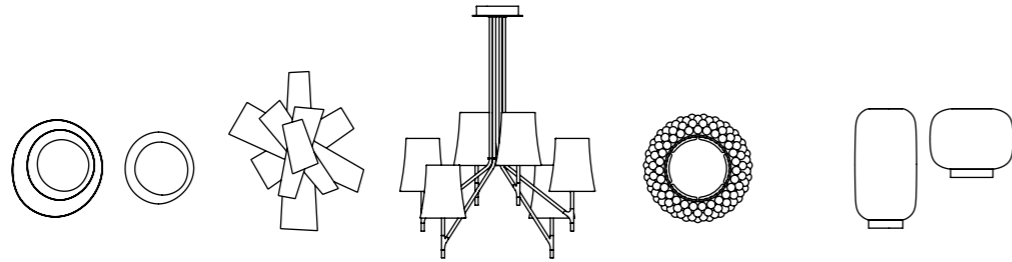

Soffitto → Bahia / Bahia mini 138 Big Bang 139 Birdie 140 Caboche Plus 141 Chouchin 142



Circus 143 Folio 144 Gem 145 Gregg 146 Lumiere XX 147 Rituals 148

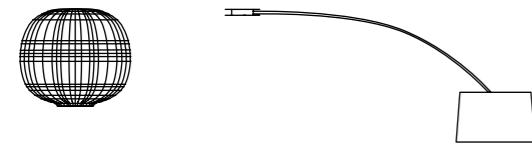

Tartan 149 Twiggy 150

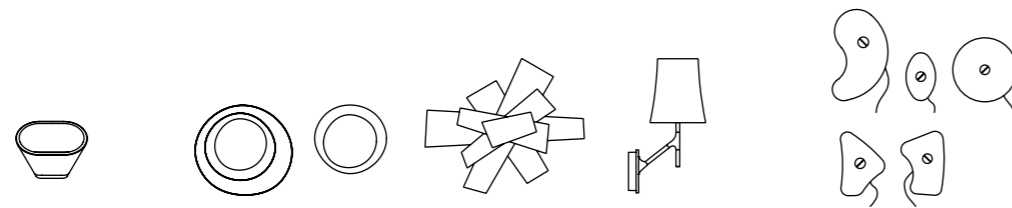

Parete → Aplomb 154 Bahia / Bahia mini 155 Big Bang 156 Birdie 157 Bit 158

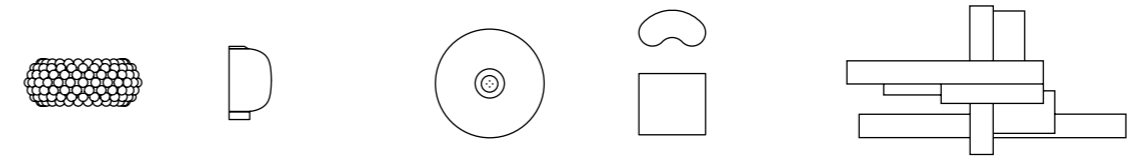

Caboche Plus 159 Chouchin semi 160 Circus 161 Double 162 Fields 163

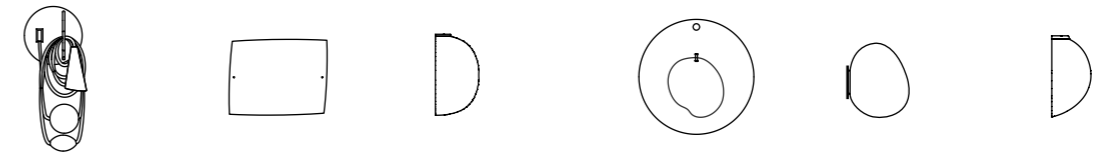

Filo 164 Folio 165 Gem semi 166 Gioia 167 Gregg 168 Gregg semi 169

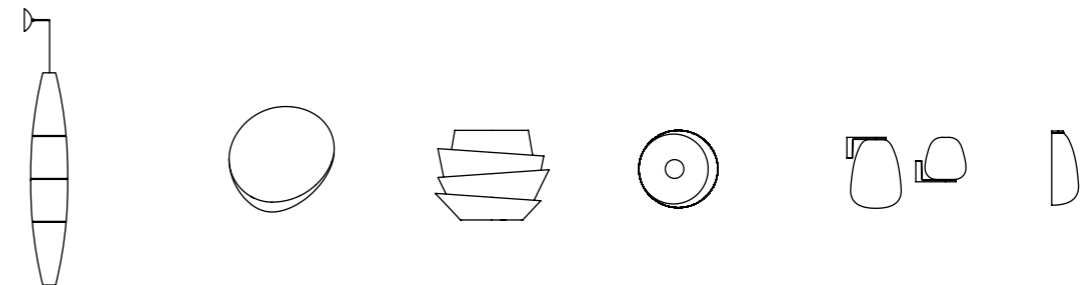







Havana 170 Lake 171 Le Soleil 172 Lumiere XX 173 Rituals 174 Rituals semi 175

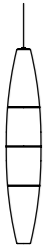

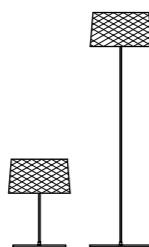
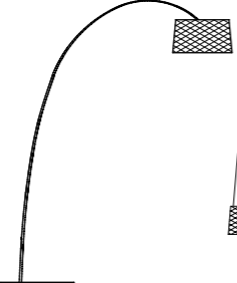

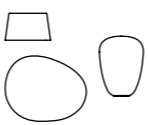

Satellight 176 Tobia 177 Tress 178 Tutù 179

				
Outdoor → Aplomb	Cri Cri	Gregg	Gregg	Havana
188	182	189	183 - 193	184

					
Havana	Solar	Twiggy Grid	Twiggy Grid	Twiggy Grid	Uto
190	185	187	186	191	192

		
Accessori → Rosoni multipli	Kit decentramento	Ricambi
126 - 133	134 - 135	198 - 201

			
MyLight Collection	LED + Dimming	Sorgenti luminose	Packing
194	195	196 - 197	202 - 209

Foscarini

VITE. Un viaggio in cinque città, tre continenti, sedici case. Per esplorare il diverso senso di luce, rivelando vite. Per scoprire che la bellezza è ovunque, se guardiamo con curiosità e stupore.

Vite

Foscarini presents VITE: real people at the centre of the story. The VITE project represents a new perspective, an updated viewpoint, an evolution in the way Foscarini operates in relation to its products. It reflects the desire to make people the central focus, to talk about light not starting with the lamp – those who have designed, developed and produced it – but about those who live with it inside their own intimate space: the home.

VITE is a voyage that takes us inside real homes – in Copenhagen, New York, Naples, Shanghai and Venice – accompanied by the artist, photographer and videomaker Gianluca Vassallo. People are at the centre of the image and the narration, while the gaze is left free to roam inside personal spaces, real spaces that are also thus imperfect. We no longer look at carefully controlled environments, the artificial and “unreachable” images of photographic sets, but at homes that are lived in on an everyday basis, close-ups of the stories of the people who dwell inside them.

→ www.foscarini.com/en/downloads

Foscarini

Collezioni Edizione — 5

31 designer, 25 materiali, 53 finiture, 22 tecnologie, 39 colori, 58 famiglie di lampade, 219 modelli diversi.

Collezioni

The complete catalogue, a dynamic and fast way to consult the complete Foscarini collection.

→ www.foscarini.com/en/downloads

Other catalogs

Maestrie — Is an extensive project – involving several artists and professionals – which sheds light on the craftsmanship skills at the heart of the production of some of Foscarini’s iconic products.

Ritratti — (“Profiles”), a brand book takes an intimate tour of five homes across Italy and an outdoor setting: the breathtaking night views of Arsenale in Venice. A collection of independent expressions on living photographed by three interior photographers.

Ambienti — Designing means choosing, and choosing a lamp means staging the right light. A catalog that talks about projects to help designers translate ideas of light into “enlightened” spaces.

→ www.foscarini.com/en/downloads



App iFoscarini

iFoscarini an app designed for all design enthusiasts who wish to customise their surroundings with the unmistakable personality of Foscarini models. With captivating and emotional graphics and extremely user-friendly it allows users to insert lamps in rooms and settings which are caught on camera each time or picked from an archive of pictures. Available on the Apple Store and Play Store the *iFoscarini* app is a very effective tool that is extremely simple to use.

MyFoscarini

With the same spirit that provides new ideas in lighting design, Foscarini creates its own more efficient programs for customer and partner communication, for instance, *MyFoscarini*, a proprietary platform, an absolutely innovative, highly flexible and transparent tool providing customers with complete information and full range of functions.

With just a few clicks in *MyFoscarini* you can:

- verificare la disponibilità delle lampade e la data di spedizione;
- check the availability of lamps and the shipping date;
- enter your orders, reserving lamps directly from Foscarini’s central system;
- track your order status;
- consult sale conditions;
- download admin documents such as transport documents and invoices;
- prepare a quotation;
- download: images, logos, PDF and excel price lists assembly instructions and certifications.

And all this 7 days a week, 24 hours a day.

If you haven’t registered yet request your password from Foscarini Customer Care.

Social media

Foscarini is present on all the main social networks with systems and languages suited to each individual channel and type of user:

- *Facebook* to create and maintain public relations, communicate news and projects, share news, images and films;
- *Instagram* to view projects and stimulate users to create images with Foscarini models;
- *Pinterest* to share images of Foscarini models and initiatives, subdividing them into theme boards;
- *LinkedIn* to create and maintain relationships with sector operators and share professional contents.

↓ Follow us:



Nile

Rodolfo Dordoni

→ Technical info p. 037



016	Anisha	030	Lumiere grande
017	Binic	031	Lumiere piccola
018	Birdie	032	Lumiere 30 th
019	Birdie Easy	033	Lumiere Nuances
020	Birdie Zero	034	Lumiere XX
021	Bridge	035	Madre
022	Buds	036	Magneto
023	Caboche Plus	037	Nile
024	Filo	038	Plass media
025	Gem	039	Poly Gregg
026	Gregg	040	Rituals
027	Gregg Alta	041	Rituals alta
028	Kurage	042	Satellight
029	Light Bulb	043	Soffio

Lievore Altherr Molina, 2011



	colours	code	€
Anisha grande	bianco	FN213001R2_10	495,00
Anisha piccola	bianco	FN2130012R2_10	394,00

Injection moulded ABS

Colours:
bianco

Weight:

Anisha grande
net kg 0,70**Anisha piccola**
net kg 0,40This product contains an energy
efficiency class F light source

Anisha grande
LED included
Power LED 4,5W 3000 K
400 lm CRI>80
Integrated touch dimmer

Anisha piccola
LED included
Power LED 3,4W 3000 K
300 lm CRI>80
Integrated touch dimmer

Transparent cable

With personalized packaging

IP 20



grande

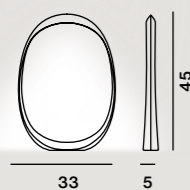

piccola

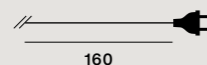
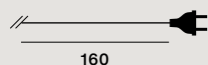
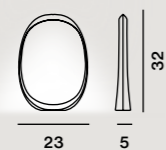

Ionna Vautrin, 2010

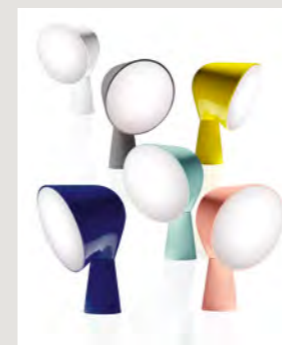

	colours	code	€
Binic	bianco	FN200001_10	162,00
	antracite	FN200001_27	
	verde acqua	FN200001_42	
	giallo	FN200001_55	
	rosa	FN200001_61	
	blu	FN200001_87	

Batch-dyed ABS and
polycarbonateColours:
bianco, antracite,
verde acqua, giallo,
rosa, bluWeight:
net kg 0,60Light bulbs not included
→ specifications p. 196Max 1x12W E14
Transparent cable

With personalized packaging

IP 20

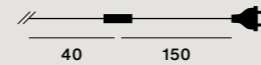
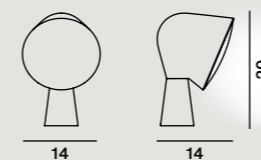

Ludovica + Roberto Palomba, 2011



	colours	code	€
Birdie grande on/off	bianco	FN221001S_10	384,00
	grigio	FN221001S_25	
	verde acqua	FN221001S_42	
	grafite	FN221001S_22	475,00
	rame	FN221001S_80	
Birdie piccola on/off	bianco	FN2210012_10	327,00
	grigio	FN2210012_25	
	verde acqua	FN2210012_42	
	grafite	FN2210012_22	405,00
	rame	FN2210012_80	
Birdie LED grande with touch dimmer	bianco	FN221001L_10	591,00
	grigio	FN221001L_25	
	verde acqua	FN221001L_42	
	grafite	FN221001L_22	682,00
	rame	FN221001L_80	
Birdie LED piccola with touch dimmer	bianco	FN2210012L_10	474,00
	grigio	FN2210012L_25	
	verde acqua	FN2210012L_42	
	grafite	FN2210012L_22	551,00
	rame	FN2210012L_80	

Polycarbonate or ABS, liquid coated steel and metal

Birdie grande on/off
Max 1x150W E27

Birdie piccola on/off
Max 1x70W E27

Birdie LED ^{LED} grande/piccola
LED included
8,4 W 2700 K
655 lm CRI>80

Transparent cable
CE IP 20

Colours:
bianco, grigio,
verde acqua, grafite, rame

Weight:
Birdie grande
net kg 4,00

Birdie LED ^{LED}
Contains an energy
efficiency class F light source

Birdie piccola
net kg 2,00

Birdie on/off
Light bulbs not included
→ specifications p. 196

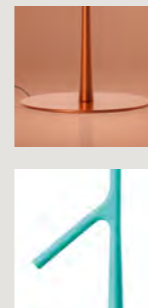
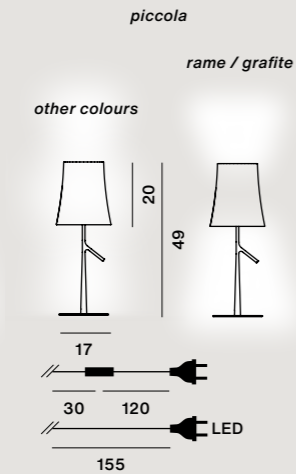
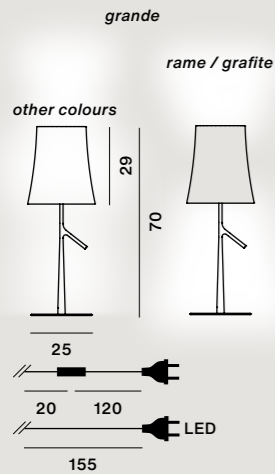
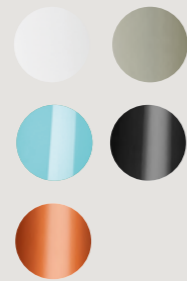

Ludovica + Roberto Palomba, 2020



	colours	code	€
Birdie Easy grande	bianco	FN221020_12	301,00
	nero	FN221020_20	
	azzurro	FN221020_30	
	verde salvia	FN221020_44	
	giallo sabbia	FN221020_56	
	rosso mattone	FN221020_64	
Birdie Easy	bianco	FN221022_12	244,00
	nero	FN221022_20	
	azzurro	FN221022_30	
	verde salvia	FN221022_44	
	giallo sabbia	FN221022_56	
	rosso mattone	FN221022_64	

Polycarbonate and liquid coated metal.

Max 1x57W E27

Transparent cable

CE IP 20

Colours:
bianco, nero, azzurro,
verde salvia, giallo sabbia,
rosso mattone

Weight:
Birdie Easy grande
net kg 3,50

Light bulbs not included
→ specifications p. 196

Birdie Easy
net kg 1,80



Birdie Easy grande

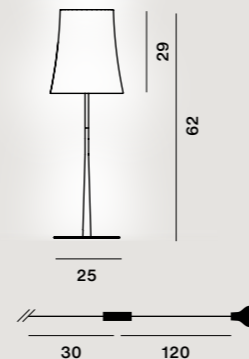

Birdie Easy

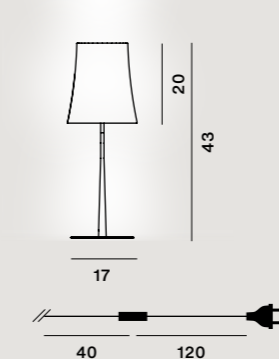

Collection →

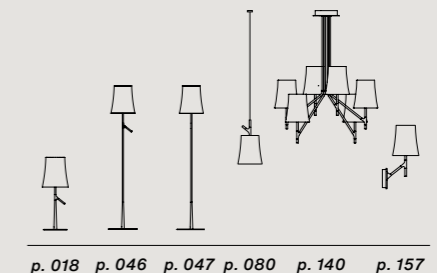

Birdie Zero

Tavolo / Table

Ludovica + Roberto Palomba, 2021



	colours	code	€
<i>Birdie Zero piccola</i>	bianco	FN221023_12	181,00
<i>Birdie Zero grande</i>	bianco	FN221021_12	217,00

Polycarbonate and coated metal.

Max 1x57W E27

Transparent cable

CE IP 20

Colours:
bianco



Weight:
Birdie piccola
net kg 1,40

Birdie grande
net kg 1,90

Light bulbs not included
→ specifications p. 196

grande

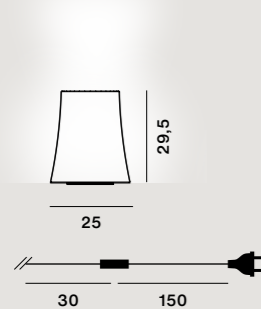

piccola



Collection →

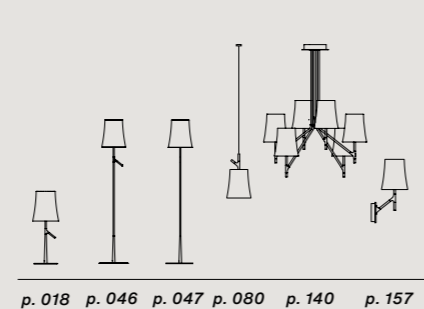

Bridge

LED

Tavolo / Table

Francesco Meda, 2022



	colours	code	€
<i>Bridge 1</i>	rosso scuro	FN3200T100-63E00	340,00
	ottone	FN3200T100-74E00	437,00
<i>Bridge 2</i>	rosso scuro	FN3200T200-63E00	314,00
	ottone	FN3200T200-74E00	397,00

Bent and painted laser cut metal.

LED included

Bridge 1
6,2 W 2700K
800 lm* Cri>90

Bridge 2
3,4W 2700K
340 lm* Cri>90

* To be confirmed

Proximity sensor switch on the lamp

CE IP 20

Colours:
rosso scuro, ottone



Weight:
Bridge 1
net kg 0,40

Bridge 2
net kg 0,35

Bridge 1

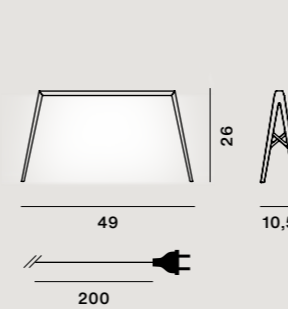

Bridge 2



Buds

Tavolo / Table

Rodolfo Dordoni, 2016



	colours	code	€
Buds 1	bianco caldo	FN278011_12	1.025,00
Buds 2	bianco caldo	FN278012_12	1.067,00
	grigio	FN278012_24	
Buds 3	bianco caldo	FN278013_12	977,00
	verde	FN278013_40	

Hand-blown cased glass and PMMA

Buds 1-2
Max 1x23W E27

Buds 3
Max 1x15W E27

Recommended white globe bulb

Transparent cable

☐ CE IP 20

Colours:

Buds 1 bianco caldo
Buds 2 bianco caldo,
grigio
Buds 3 bianco caldo,
verde bambù



Weight:

Buds 1
net kg 4,90

Buds 2
net kg 6,20

Buds 3
net kg 4,20

Light bulbs not included
→ specifications p. 196

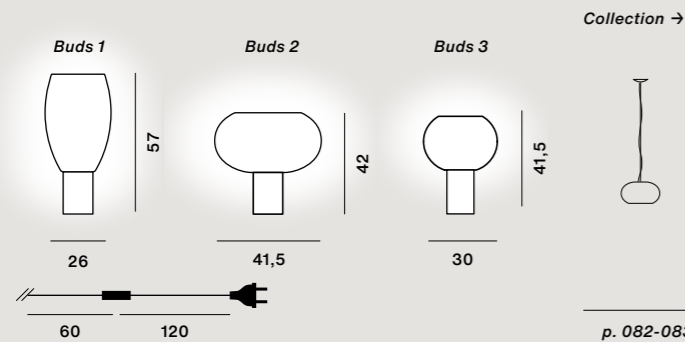

Caboche Plus

LED

Tavolo / Table

Patricia Urquiola con Eliana Gerotto, 2005-2021



	colours	code	€
Caboche Plus	trasparente	FN311021R1_16	850,00
	grigio	FN311021R1_25	

PMMA, polycarbonate,
aluminium and liquid coated
metal

LED included
10W 2700 K
930 lm CRI >90
Dimmer included

Transparent cable

☐ CE IP 20

Colours:
trasparente, grigio



Weight:
net kg 5,40

This product contains an energy
efficiency class F light source

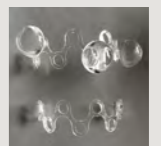
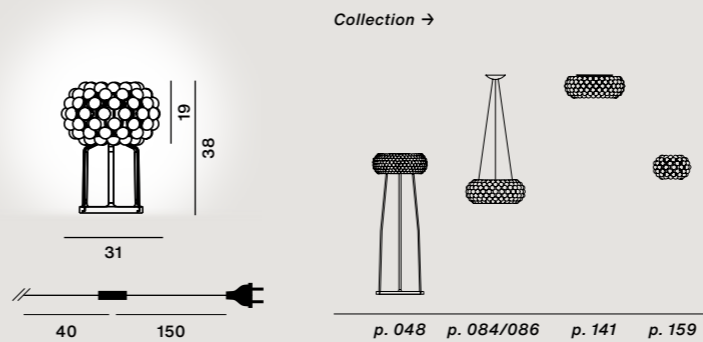



Andrea Anastasio, 2017



	colours	code	€
Filo	amethyst queen	FN289001_01	458,00
	teodora	FN289001_04	
	southern talisman	FN289001_05	
	ruby jaypure	FN289001_06	
	emerald king	FN289001_08	
	** eastern coral	FN289001_02	
	** koh-i-noor	FN289001_03	
	** izmir	FN289001_07	

Porcelain, textile cable, blown glass and varnished metal

LED retrofit included
4W G9 3000 K
400 lm CRI>80

With personalized packaging

☑ CE IP 20

Colours:

Amethyst Queen
white / black cable

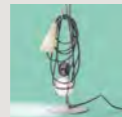

Teodora
petrol green cable



Weight:
net kg 4,20

**
Limited stock available

Southern Talisman
bordeaux cable



Ruby Jaypure
petrol green cable



Emerald King
red / white cable



Eastern Coral **
fluo orange cable



Koh-i-noor **
fluo orange cable

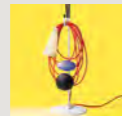

Izmir **
fluo fuchsia cable



Collection →

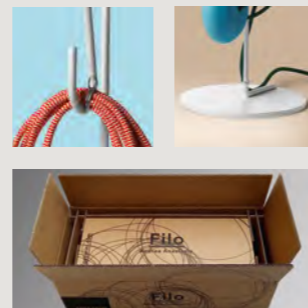
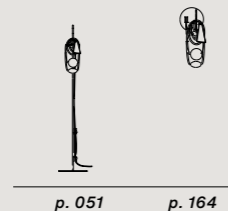
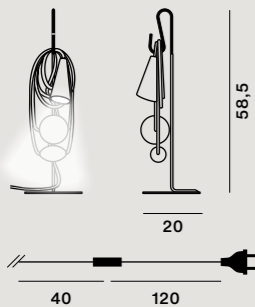

Ludovica + Roberto Palomba, 2017 - 2019



	colours	code	€
Gem tavolo	bianco	FN274001_10	928,00
Gem tavolo alta	** bianco/bianco	FN274011EB_10	793,00
	** oro/bianco	FN274011EG_10	954,00
	** grafite/bianco	FN274011EN_10	

Hand-blown cased acid-etched glass with reliefs, gold-plating satin metal or coated metal

Gem tavolo
Max 1x150W E27
Dimmer included

☑ CE IP 20

Gem tavolo alta
Max 1x57W E27
Dimmer included

☑ CE IP 20

Transparent cable

The gold color of the base is different in the table vs. the high table version



Please verify the compatibility of your bulb with the dimmer's wattage ranges, indicated on the dimmer itself, according to the kind of light source.

Glass colours:
bianco



Frame colours
tavolo alta:
bianco, oro, grafite



Weight:
Gem tavolo
net kg 8,30

Gem tavolo alta
net kg 10,20

Light bulbs not included
→ specifications p. 196

**
Limited stock available

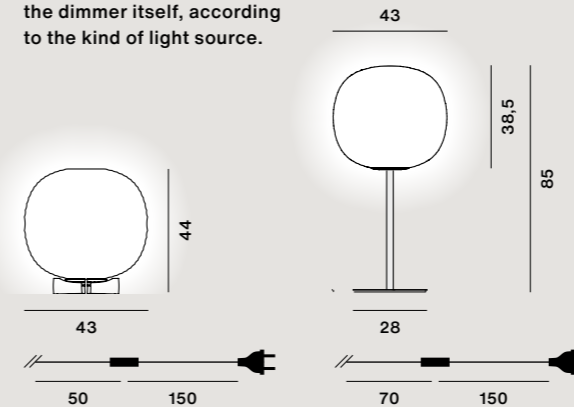

Collection →

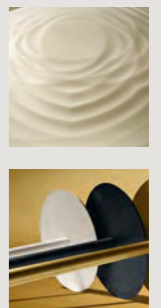
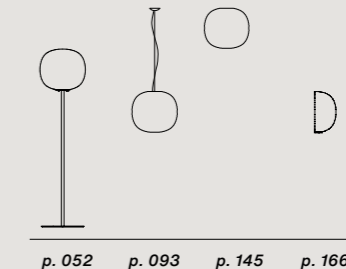

Ludovica + Roberto Palomba, 2007 - 2019



	colours	code	€
Gregg grande tavolo	bianco	FN1680011_10	724,00
with dimmer	**oro/bianco	FN1680011G_10	766,00
	**grafite/bianco	FN1680011N_10	
Gregg grande tavolo	bianco	FN1680011S_10	697,00
on/off	**oro/bianco	FN1680011SG_10	740,00
	**grafite/bianco	FN1680011SN_10	
Gregg media tavolo	bianco	FN168001_10	439,00
with dimmer	**oro/bianco	FN168001G_10	481,00
	**grafite/bianco	FN168001N_10	
Gregg media tavolo	bianco	FN168001S_10	413,00
on/off	**oro/bianco	FN168001SG_10	455,00
	**grafite/bianco	FN168001SN_10	
Gregg midi tavolo	bianco	FN168031E_10	353,00
Gregg piccola tavolo	bianco	FN1680012D1B10	205,00
with dimmer			
Gregg piccola tavolo on/off	bianco	FN1680012S1B10	165,00

Hand blown acid-etched glass and coated metal or polycarbonate

Gregg grande - media
Max 1x150W E27

Gregg midi LED retrofit included
1x6,5W E14 2700K
806 lm CRI>80
Dimmer included

Gregg piccola
Max 1x8W G9

Transparent cable
 IP 20

Please verify the compatibility of your bulb with the dimmer's wattage ranges, indicated on the dimmer itself, according to the kind of light source.

Glass colours:
bianco



Weight:
Gregg grande
net kg 6,80

**
Limited stock available

Gregg media
net kg 3,30

Light bulbs not included
→ specifications p. 196

Frame colours:
bianco, oro, grafite

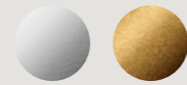

Gregg midi
net kg 1,60

Gregg piccola
net kg 0,60

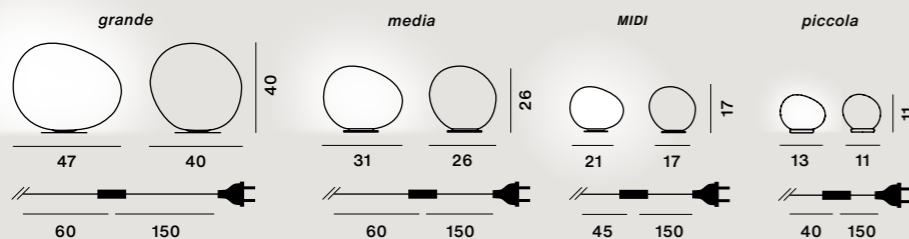

Ludovica + Roberto Palomba, 2007 - 2019



	colours	code	€
Gregg grande alta	**bianco/bianco	FN1680211EB_10	873,00
	**oro/bianco	FN1680211EG_10	1.032,00
	**grafite/bianco	FN1680211EN_10	
Gregg media alta	**bianco/bianco	FN168021EB_10	676,00
	**oro/bianco	FN168021EG_10	834,00
	**grafite/bianco	FN168021EN_10	

Hand-blown cased acid-etched glass and coated metal

Max 1x57W E27
Dimmer included

Transparent cable

IP 20

Please verify the compatibility of your bulb with the dimmer's wattage ranges, indicated on the dimmer itself, according to the kind of light source.

Glass colours:
bianco



Weight:
Gregg grande tavolo alta
net kg 9,80

**
Limited stock available

Light bulbs not included
→ specifications p. 196

Gregg media tavolo alta
net kg 6,10

Frame colours:
bianco, oro, grafite

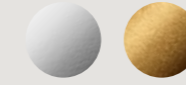

grande tavolo alta

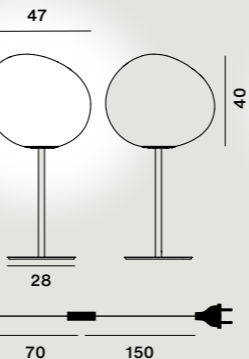

media tavolo alta

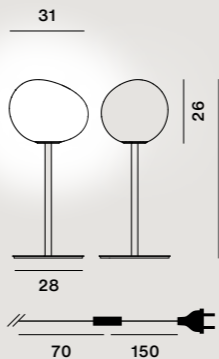

Collection →

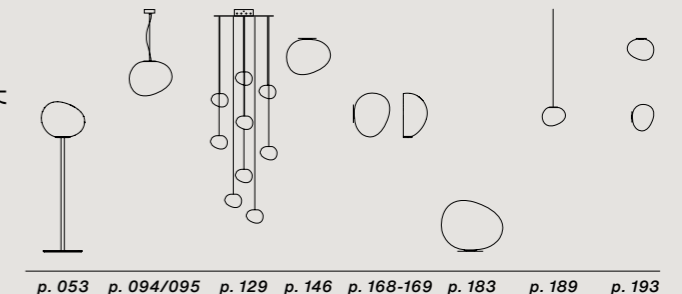

p. 053 p. 094/095 p. 129 p. 146 p. 168-169 p. 183 p. 189 p. 193

Nichetto + Nendo, 2015



	colours	code	€
Kurage	bianco	FN258001_10	649,00

Washi paper and ashwood

Max 1x20W E27
Cable covered with natural paper color fiber

With personalized packaging

☐ CE IP 20

Colours:
bianco



Weight:
net kg 0,70

Light bulbs not included
→ specifications p. 196

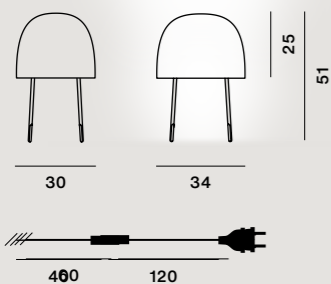

James Wines / SITE, 2018



	colours	code	€
Light Bulb	bianco	FN293001_10	393,00
	nero	FN293001_20	

Blown glass and aluminium

LED included 3W 2700 K
440 lm 146 lm/W CRI>80
Transparent cable
Dimmer included

With personalized packaging

☐ CE IP 20

Colours:
bianco, bianco/nero



Weight:
net kg 0,80

This product contains an energy
efficiency class D light source

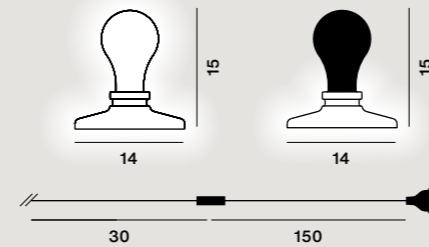

The Light Bulb Series

James Wines, 2018 - Limited edition

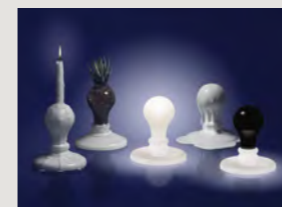

	code	€
Black Light	FN293COLLECTION	
White Light		
Candle Light		
Plant Light		
Melting Light		3.219,00



Rodolfo Dordoni, 1990



Hand-blown cased glass and painted brushed aluminum

Lumiere grande
LED retrofit included
1x11W E27 2700K
1521 lm CRI>80

Transparent cable

With personalized packaging



Please verify the compatibility of your bulb with the dimmer's wattage ranges, indicated on the dimmer itself, according to the kind of light source.

	colours	code	€
Lumiere grande on/off	alluminio/bianco	FN026001EA_11	589,00
	alluminio/bianco caldo	FN026001EA_12	669,00
	alluminio/ciliegia	FN026001EA_62	
Lumiere grande on/off	cromo nero/bianco	FN026001EC_11	589,00
	cromo nero/bianco caldo	FN026001EC_12	669,00
	cromo nero/ciliegia	FN026001EC_62	
Lumiere grande on/off	champagne/bianco	FN026001EH_11	589,00
	champagne/bianco caldo	FN026001EH_12	669,00
	champagne/ciliegia	FN026001EH_62	
Lumiere grande with dimmer	alluminio/bianco	FN026001EA_11D	630,00
	alluminio/bianco caldo	FN026001EA_12D	709,00
	alluminio/ciliegia	FN026001EA_62D	
Lumiere grande with dimmer	cromo nero/bianco	FN026001EC_11D	630,00
	cromo nero/bianco caldo	FN026001EC_12D	709,00
	cromo nero/ciliegia	FN026001EC_62D	
Lumiere grande with dimmer	champagne/bianco	FN026001EH_11D	630,00
	champagne/bianco caldo	FN026001EH_12D	709,00
	champagne/ciliegia	FN026001EH_62D	

Glass colours:
bianco, bianco caldo,
ciliegia

Weight:
net kg 2,40

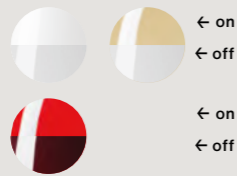

Frame colours:
alluminio, cromo nero,
champagne

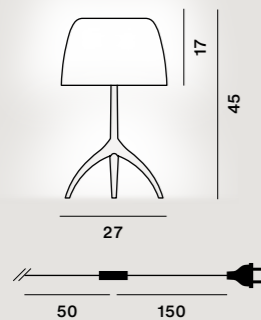

Collection →

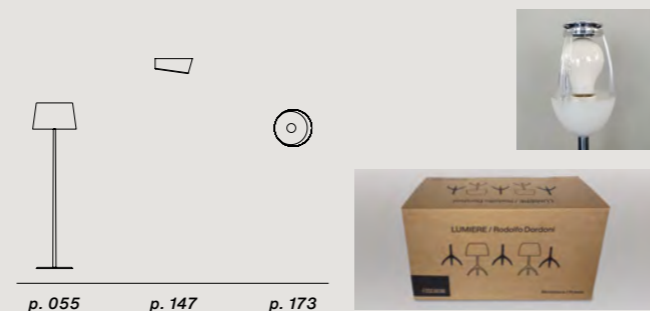

Rodolfo Dordoni, 1990



Hand-blown cased glass and painted brushed aluminum

Lumiere piccola
LED retrofit included
1x6,5W E14 2700K
806 lm CRI>80

Transparent cable

With personalized packaging



Please verify the compatibility of your bulb with the dimmer's wattage ranges, indicated on the dimmer itself, according to the kind of light source.

	colours	code	€
Lumiere piccola on/off	alluminio/bianco	FN026021EA_11	405,00
	alluminio/bianco caldo	FN026021EA_12	480,00
	alluminio/ciliegia	FN026021EA_62	
Lumiere piccola on/off	cromo nero/bianco	FN026021EC_11	405,00
	cromo nero/bianco caldo	FN026021EC_12	480,00
	cromo nero/ciliegia	FN026021EC_62	
Lumiere piccola on/off	champagne/bianco	FN026021EH_11	405,00
	champagne/bianco caldo	FN026021EH_12	480,00
	champagne/ciliegia	FN026021EH_62	
Lumiere piccola with dimmer	alluminio/bianco	FN026021EA_11D	445,00
	alluminio/bianco caldo	FN026021EA_12D	520,00
	alluminio/ciliegia	FN026021EA_62D	
Lumiere piccola with dimmer	cromo nero/bianco	FN026021EC_11D	445,00
	cromo nero/bianco caldo	FN026021EC_12D	520,00
	cromo nero/ciliegia	FN026021EC_62D	
Lumiere piccola with dimmer	champagne/bianco	FN026021EH_11D	445,00
	champagne/bianco caldo	FN026021EH_12D	520,00
	champagne/ciliegia	FN026021EH_62D	

Glass colours:
bianco, bianco caldo,
ciliegia

Weight:
net kg 1,10



Frame colours:
alluminio, cromo nero,
champagne

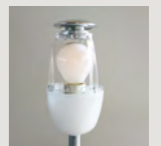
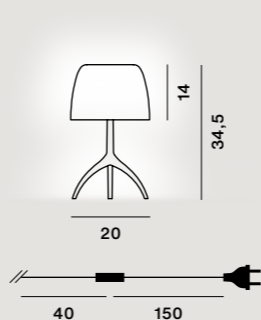



Rodolfo Dordoni, 1990 - 2020



	colours	code	€
Lumiere 30th grande	champagne/bulles	FN026001EH_13	704,00
on/off	champagne/pastilles	FN026001EH_14	
Lumiere 30th grande	champagne/bulles	FN026001EH_13D	745,00
with dimmer	champagne/pastilles	FN026001EH_14D	
Lumiere 30th piccola	champagne/bulles	FN026021EH_13	506,00
on/off	champagne/pastilles	FN026021EH_14	
Lumiere 30th piccola	champagne/bulles	FN026021EH_13D	546,00
with dimmer	champagne/pastilles	FN026021EH_14D	

Hand-blown cased glass and painted brushed aluminum

Lumiere 30th grande
LED retrofit included
1x11W E27 2700K
1521 lm CRI>80

Lumiere 30th piccola
LED retrofit included
1x6,5W E14 2700K
806 lm CRI>80

Transparent cable



Please verify the compatibility of your bulb with the dimmer's wattage ranges, indicated on the dimmer itself, according to the kind of light source.

Glass colours:
bulles, pastilles



Weight:
Grande
net kg 2,40

Piccola
net kg 1,10

Frame colours:
champagne

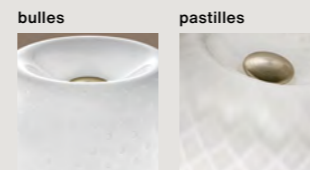
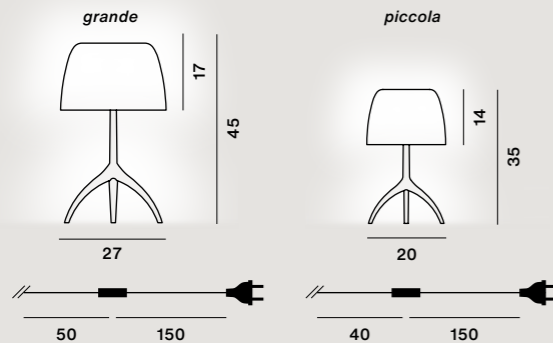

Rodolfo Dordoni, 1990 - 2021



	colours	code	€
Lumiere Nuances grande	creta	FN026001E_26D	709,00
with dimmer	sahara	FN026001E_58D	
	cipria	FN026001E_61D	
Lumiere Nuances piccola	creta	FN026021E_26D	520,00
with dimmer	sahara	FN026021E_58D	
	cipria	FN026021E_61D	

Hand-blown cased glass and painted brushed aluminum

Lumiere Nuances grande
LED retrofit included
1x11W E27 2700K
1521 lm CRI>80
Dimmer included

Lumiere Nuances piccola
LED retrofit included
1x6,5W E14 2700K
806 lm CRI>80
Dimmer included

Transparent cable

With personalized packaging



Please verify the compatibility of your bulb with the dimmer's wattage ranges, indicated on the dimmer itself, according to the kind of light source.

Glass colours:
creta, sahara, cipria

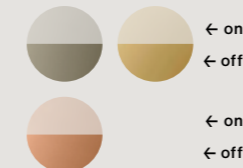

Frame colours:
creta, sahara, cipria



Weight:
Grande
net kg 2,40

Piccola
net kg 1,10

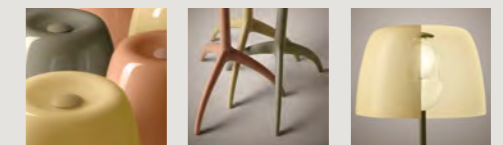
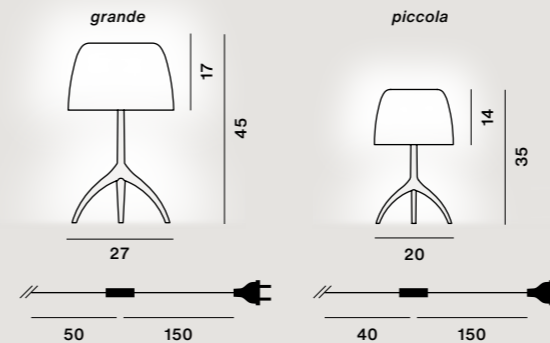

Lumiere XXL - XXS

Tavolo / Table

Rodolfo Dordoni, 2009



	colours	code	€
Lumiere XXL	alluminio/bianco	FN191001A_11	1.059,00
	alluminio/grigio	FN191001A_24	
	cromo nero/bianco	FN191001C_11	
	cromo nero/grigio	FN191001C_24	
Lumiere XXS	alluminio/bianco	FN1910012A_11	688,00
	alluminio/grigio	FN1910012A_24	
	cromo nero/bianco	FN1910012C_11	
	cromo nero/grigio	FN1910012C_24	

Hand-blown cased glass and painted brushed aluminum

Lumiere XXL
Max 4x33W G9
Dimmer included

Lumiere XXS
Max 1x48W G9
Dimmer included

Transparent cable

☐ CE ⚡ IP 20

⚙️
Please verify the compatibility of your bulb with the dimmer's wattage ranges, indicated on the dimmer itself, according to the kind of light source.

Glass colours:
bianco, grigio freddo



Weight:
Lumiere XXL
net kg 5,50

Lumiere XXS
net kg 1,80

Light bulbs not included
→ specifications p. 196

Frame colours:
alluminio, cromo nero



Lumiere XXL

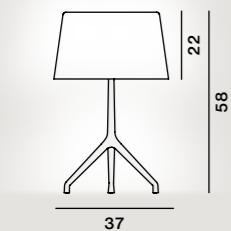

Lumiere XXS



Collection →

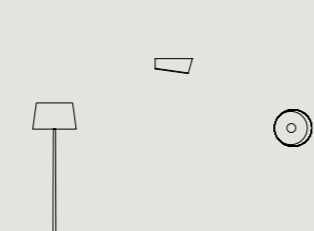

p. 055 p. 147 p. 173



Madre

LED

Tavolo / Table

Andrea Anastasio, 2019



	colours	code	€
Madre	bianco	FN301001_10	1.046,00

Hand-blown cased acid-etched glass, borosilicate glass, varnished aluminum and polycarbonate

LED included
16W 2700 K
1445 lm CRI>80
Dimmer included

Light gray cable

☐ CE ⚡ IP 20

In the upper hollow dry branches or leaves can be placed, do not use liquids.

Colours:
bianco



Weight:
net kg 4,20

This product contains an energy efficiency class F light source

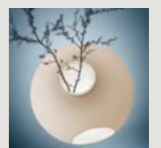
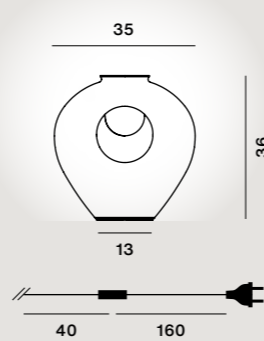

Giulio Iacchetti, 2011



	colours	code	€
Magneto	bianco	FN202001R3_10	436,00
	nero	FN202001R3_20	

Coated steel, ABS and super magnet made of "rare earth"

Colours: bianco, nero

Weight: net kg 1,30

This product contains an energy efficiency class G light source

LED included
Power LED 5W 2700 K
475 lm CRI>80



Black cable

CE IP 20

With personalized packaging

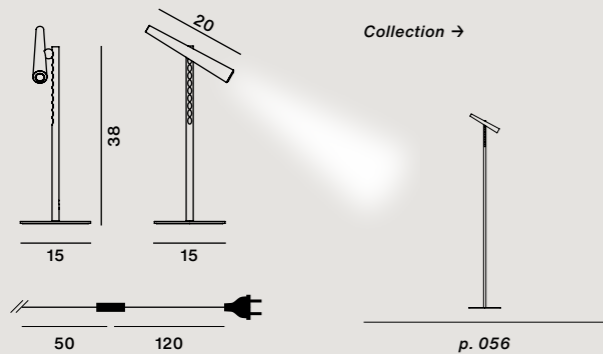

Rodolfo Dordoni, 2021

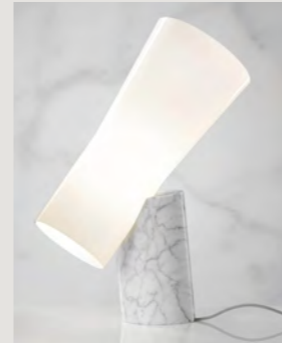

	colours	code	€
Nile	bianco	FN3160TOD-10E00	1.288,00
	nero	FN3160TOD-20E00	1.341,00

Hand-blown cased glass and Carrara or Marquina marble.

Glass colours: bianco

Weight: net kg 10,20

Video brochure:



LED retrofit included
1x18W E27 2700 K
2452 lm CRI>80
Dimmer included



Woven fabric cable in grey and white.

Frame colours: bianco, nero



CE IP 20

With personalized packaging

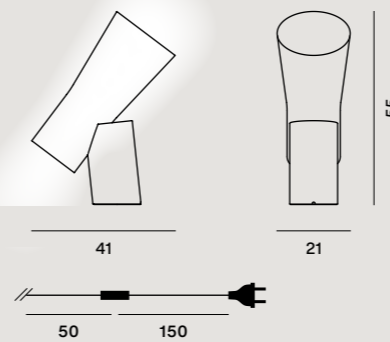

Plass media

Tavolo / Table

Luca Nichetto, 2015



	colours	code	€
Plass media on/off	grigio	FN2240012_25	533,00
	azzurro	FN2240012_30	
Plass media with dimmer	grigio	FN2240012D_25	564,00
	azzurro	FN2240012D_30	

Rotational moulded polycarbonate and varnished steel

Colours: grigio, azzurro

Weight: net kg 4,00

Light bulbs not included → specifications p. 196

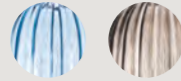

Plass media
Max 1x150W E27

Transparent cable

☐ CE IP 20



Please verify the compatibility of your bulb with the dimmer's wattage ranges, indicated on the dimmer itself, according to the kind of light source.

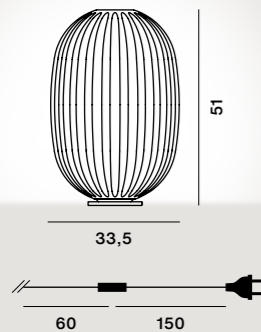

Collection →

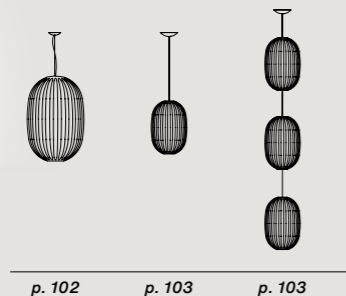

p. 102

p. 103

p. 103

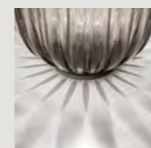

Poly Gregg

Tavolo / Table

Ludovica + Roberto Palomba, 2011



	colours	code	€
Poly Gregg X-large	bianco	FN2180030_10	471,00
Poly Gregg grande	bianco	FN2180130_10	367,00
Poly Gregg media	bianco	FN2180230_10	258,00

Rotational moulded polyethylene

Colours: bianco

Weight: **X-large**
net kg 4,30

Light bulbs not included → specifications p. 196



X-large / grande
Max 1x25W E27

grande
net kg 3,60

media
Max 1x15W E27

media
net kg 1,60

Transparent cable

☐ CE IP 20

X-large

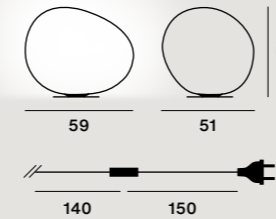

grande

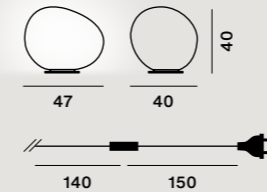

media



Collection →

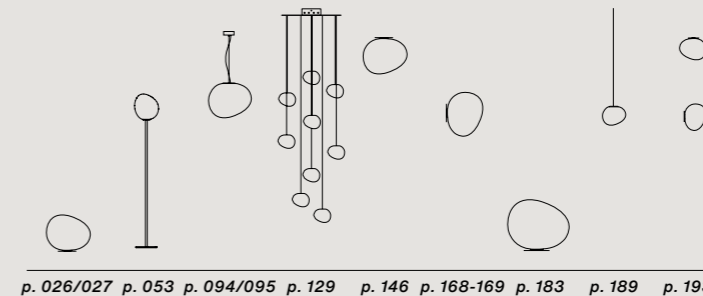

p. 026/027

p. 053

p. 094/095

p. 129

p. 146

p. 168-169

p. 183

p. 189

p. 193

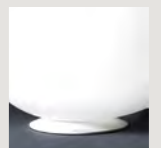

Ludovica + Roberto Palomba, 2012 - 2014



	colours	code	€
<i>Rituals 1 on/off</i>	bianco	FN2440011_10	461,00
<i>Rituals 1 with dimmer</i>	bianco	FN2440011D1_10	512,00
<i>Rituals 2 on/off</i>	bianco	FN2440012_10	461,00
<i>Rituals 2 with dimmer</i>	bianco	FN2440012D1_10	512,00
<i>Rituals 3 on/off</i>	bianco	FN2440013_10	387,00
<i>Rituals 3 with dimmer</i>	bianco	FN2440013D1_10	437,00
<i>Rituals XL on/off</i>	bianco	FN2440014_10	689,00
<i>Rituals XL with dimmer</i>	bianco	FN2440014D_10	716,00

Hand-blown cased engraved satin glass and coated metal

Colours: bianco

Weight: *Rituals 1* net kg 4,00

Light bulbs not included → specifications p. 196

Rituals 1-2-3
Max 1x105W E27



Rituals 2
net kg 4,10

Rituals XL
Max 1x150W E27

Rituals 3
net kg 1,60

Transparent cable

☐ CE ⚡ IP 20

Rituals XL
net kg 6,60

⦿
Please verify the compatibility of your bulb with the dimmer's wattage ranges, indicated on the dimmer itself, according to the kind of light source

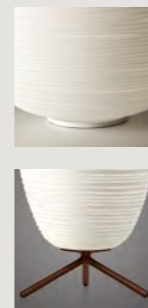
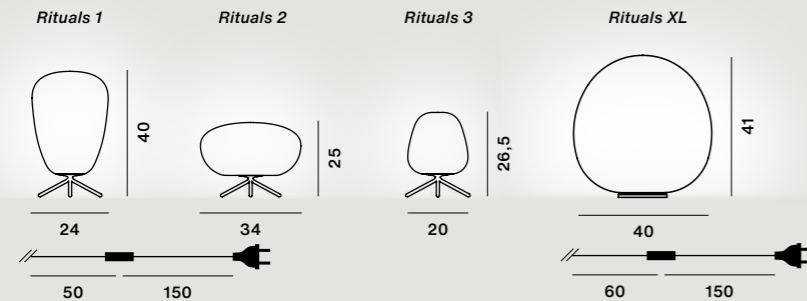

Ludovica + Roberto Palomba, 2012 - 2019



	colours	code	€
<i>Rituals 1 tavolo alta</i>	**bianco/bianco	FN244021EB_10	771,00
	**oro/bianco	FN244021EG_10	934,00
	**grafite/bianco	FN244021EN_10	
<i>Rituals XL tavolo alta</i>	**bianco/bianco	FN244024EB_10	908,00
	**oro/bianco	FN244024EG_10	1.072,00
	**grafite/bianco	FN244024EN_10	

Hand-blown cased engraved satin glass and coated metal

Glass colours: bianco

Weight: *Rituals 1 tavolo alta* net kg 8,20

Light bulbs not included → specifications p. 196

Max 1x57W E27
Dimmer included



Rituals XL tavolo alta net kg 10,20

**
Limited stock available

Transparent cable

☐ CE ⚡ IP 20

Frame colours: bianco, oro, grafite



⦿
Please verify the compatibility of your bulb with the dimmer's wattage ranges, indicated on the dimmer itself, according to the kind of light source.

Rituals 1 tavolo alta

Rituals XL tavolo alta

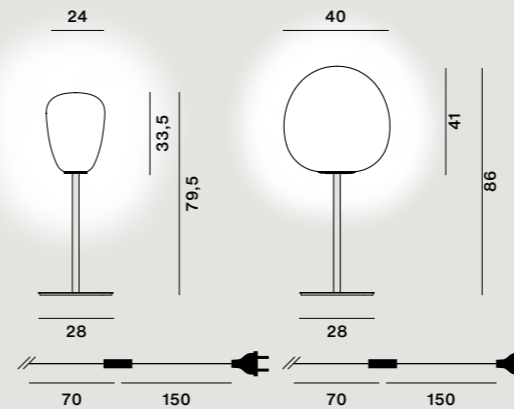

Collection →

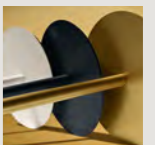

Satellight



Tavolo / Table

Eugeni Quitllet, 2017



	colours	code	€
Satellight with touch dimmer	bianco/trasparente	FN285021D_15	631,00
Satellight on/off **	bianco/trasparente	FN285021_15	562,00

Hand-blown crystal glass and cased acid-etched glass, aluminium

Colours: bianco/trasparente

Weight: net kg 2,50

This product contains an energy efficiency class F light source

LED included
Mid power 8,4W 2700 K
655 lm CRI>80



**
Limited stock available

Transparent cable



Soffio



Tavolo / Table

Ludovica + Roberto Palomba, 2018



	colours	code	€
Soffio	bianco sfumato	FN300001A_10	846,00

Hand-blown crystal glass and cased glass and aluminium

Colours: trasparente and bianco sfumato

Weight: net kg 3,10

This product contains an energy efficiency class F light source

LED included
Mid power 13,8 W 2700 K
1300 lm CRI>80
Integrated touch dimmer



Transparent cable

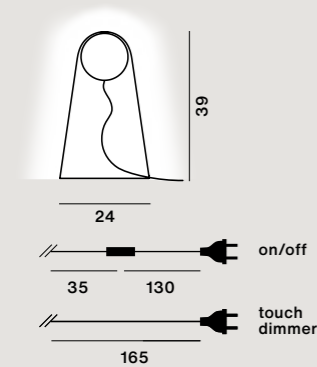

Collection →



p. 106 p. 176

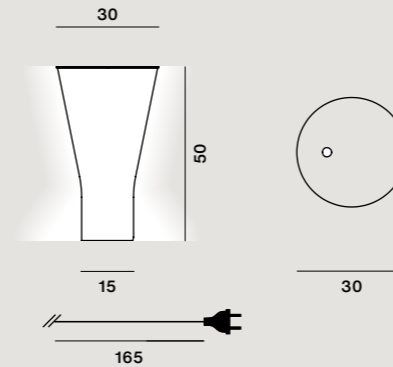
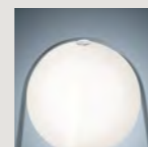

Chiaroscuro

Alberto + Francesco Meda

→ Technical info p. 049

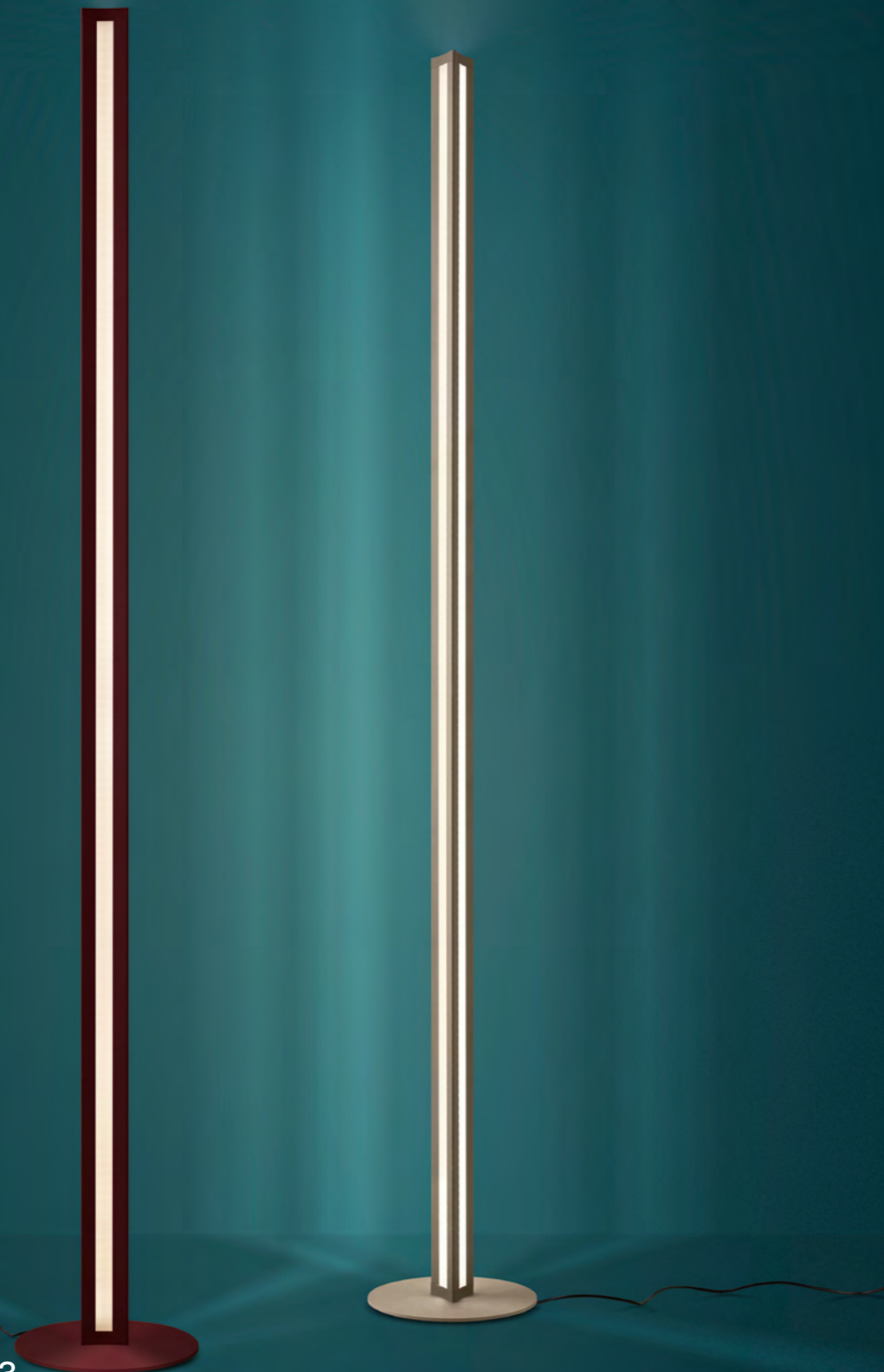

Index

Terra / Floor

046	Birdie	058	Orbital
047	Birdie Easy	059	Rituals
048	Caboche Plus	060	Tobia
049	Chiaroscuro	061	Tress
050	Dolmen	062	Tuareg
051	Filo	063	Twice as Twiggy
052	Gem	064	Twiggy
053	Gregg	065	Twiggy LED
054	Havana	066	Twiggy Elle
055	Lumiere XXL	067	Twiggy Wood
056	Magneto	068	Twiggy lettura
057	Mite	069	Uptown

Terra

Birdie

Terra / Floor

Ludovica + Roberto Palomba, 2011



	colours	code	€
Birdie on/off	bianco	FN221004S_10	456,00
	grigio	FN221004S_25	
	verde acqua	FN221004S_42	
	grafite	FN221004S_22	546,00
Birdie LED <i>with touch dimmer</i>	rame	FN221004S_80	
	bianco	FN221004L_10	659,00
	grigio	FN221004L_25	
	verde acqua	FN221004L_42	
	grafite	FN221004L_22	750,00
	rame	FN221004L_80	

Polycarbonate or ABS, liquid coated steel and metal

Colours: bianco, grigio, verde acqua, grafite, rame

Weight: net kg 4,30

Birdie LED Contains an energy efficiency class F light source

Birdie on/off Light bulbs not included → specifications p. 196

Birdie on/off
Max 1x150W E27

Birdie LED
LED included
Mid power 8,4W 2700 K
655 lm CRI>80

Transparent cable

IP 20

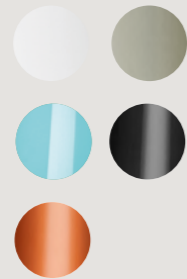

other colours

rame / grafite

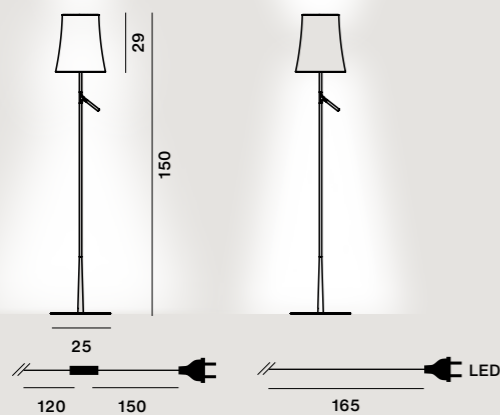

Birdie Easy

Terra / Floor

Ludovica + Roberto Palomba, 2020

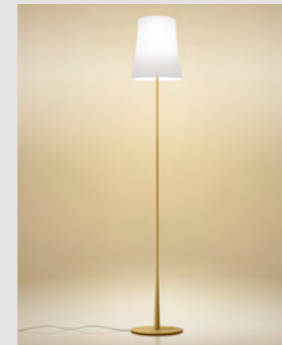

	colours	code	€
Birdie Easy lettura	bianco	FN221024_12	371,00
	nero	FN221024_20	
	azzurro	FN221024_30	
	verde salvia	FN221024_44	
	giallo sabbia	FN221024_56	
	rosso mattone	FN221024_64	

Polycarbonate and liquid coated metal

Colours: bianco, nero, azzurro, verde salvia, giallo sabbia, rosso mattone

Weight: net kg 4,10

Light bulbs not included → specifications p. 196

Max 1x57W E27

Transparent cable

IP 20

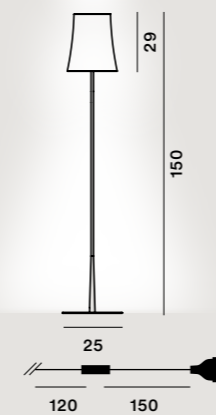

Collection →

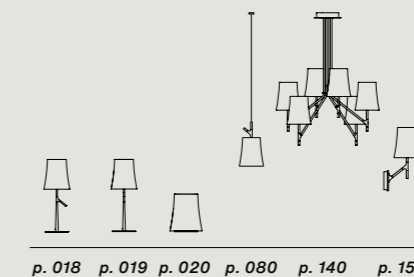

p. 018 p. 019 p. 020 p. 080 p. 140 p. 157

Patricia Urquiola con Eliana Gerotto, 2005



	colours	code	€
Caboche Plus grande	trasparente	FN311013_16	3.011,00
	grigio	FN311013_25	
Caboche Plus grande MyLight	trasparente	FN311013ML_16	3.132,00
	grigio	FN311013ML_25	
Caboche Plus media	trasparente	FN311003_16	1.702,00
	grigio	FN311003_25	
Caboche Plus media MyLight	trasparente	FN311003ML_16	1.823,00
	grigio	FN311003ML_25	

PMMA, polycarbonate, aluminium and liquid coated metal

Colours: trasparente, grigio

Weight: **Caboche grande** net kg 23,90

This product contains an energy efficiency class D light source



Caboche media net kg 11,80

Caboche Plus grande
LED included
28W 2700 K
3850 lm CRI > 90
Dimmer included

Caboche Plus media
23W 2700 K
3200 lm CRI > 90
Dimmer included

Caboche Plus MyLight
Dimmable via Bluetooth with Casambi App

Transparent cable

CE IP 20

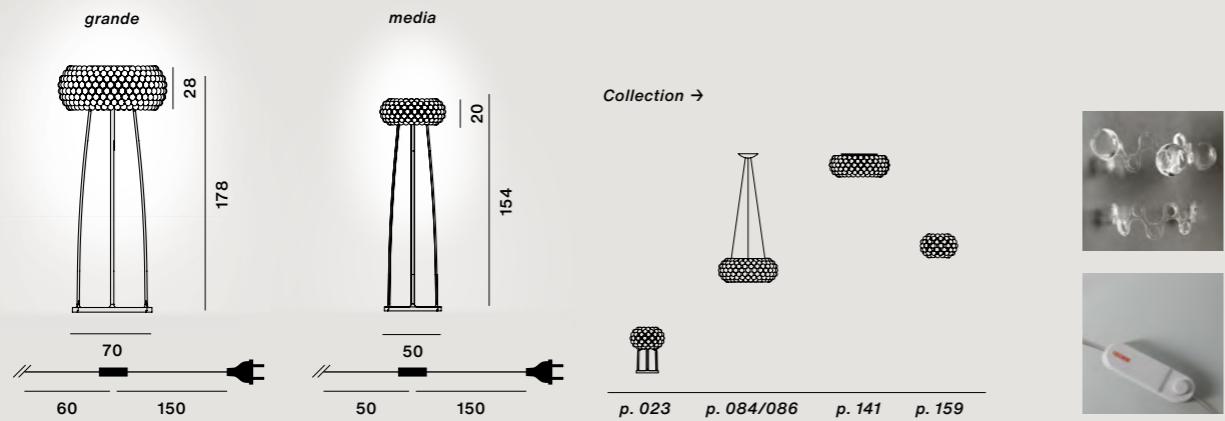

Alberto + Francesco Meda, 2021

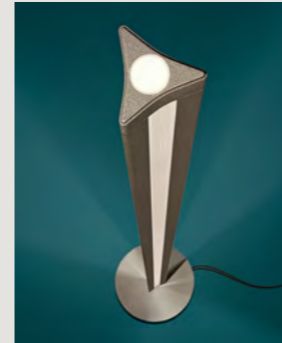

	colours	code	€
Chiaroscuro	rosso scuro	FN3150F0D-63E00	1.286,00
	titanio	FN3150F0D-74E00	

Liquid coated aluminium and metal, PMMA

Colours: rosso scuro, titanio

Weight: net kg 4,00

LED included
37W 2700 K 4730 lm CRI>80
Dimmer included



Black cable
With personalized packaging

CE IP 20

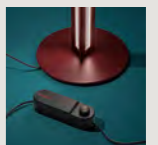
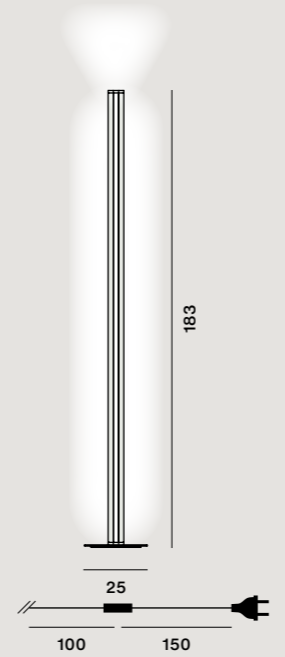

Ferruccio Laviani, 1996/2017

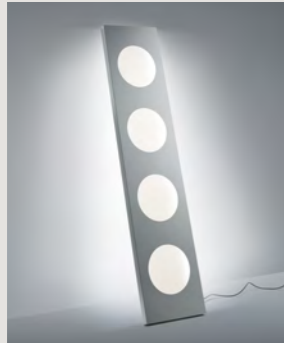

	colours	code	€
Dolmen	alluminio	FN280003_25	1.898,00

Anodised aluminium and PMMA

Colours: alluminio

Weight: net kg 11,00

This product contains an energy efficiency class E light source

LED included
47W 2700 K
6486 lm CRI>90
Dimmer included



Transparent cable

☐ CE IP 20

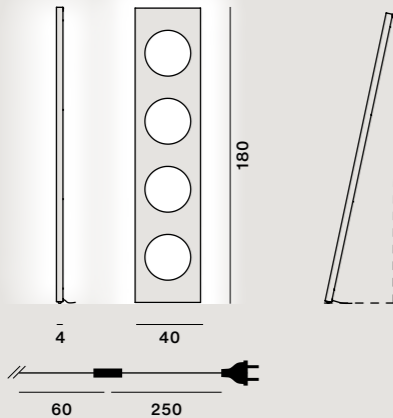

Collection →

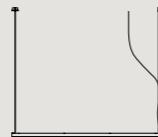

p. 092



Andrea Anastasio, 2017



	colours	code	€
Filo lettura	amethyst queen	FN289004_01	585,00
	eastern coral	FN289004_02	
	teodora	FN289004_04	
	emerald king	FN289004_08	

Porcelain, textile cable, blown glass and varnished metal

Colours: Amethyst Queen white / black cable

Eastern Coral fluo orange cable

Weight: net kg 5,70

LED retrofit included
4W G9 3000 K
400 lm CRI>80

☐ CE IP 20

With personalized packaging

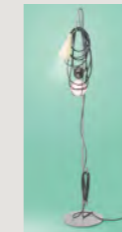

Teodora petrol green cable

Emerald King red / white cable

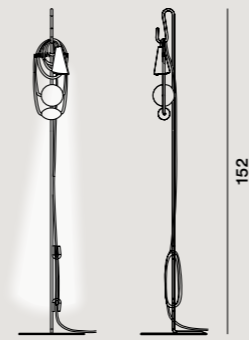
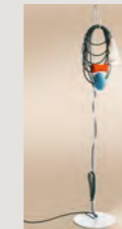

Collection →



p. 024

p. 164

60

80

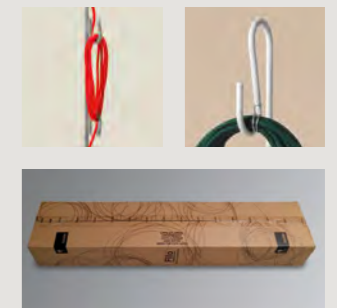

Ludovica + Roberto Palomba, 2017 - 2019



	colours	code	€
Gem terra	bianco/bianco	FN274013EB_10	941,00
	oro/bianco	FN274013EG_10	1.128,00
	grafite/bianco	FN274013EN_10	

Hand-blown cased acid-etched glass with reliefs and coated metal

Glass colours: bianco

Weight: net kg 16,00

Light bulbs not included → specifications p. 196

Max 1x57W E27
Dimmer included

Transparent cable

☐ CE ⚡ IP 20



Please verify the compatibility of your bulb with the dimmer's wattage ranges, indicated on the dimmer itself, according to the kind of light source.

Frame colours: bianco, oro, grafite

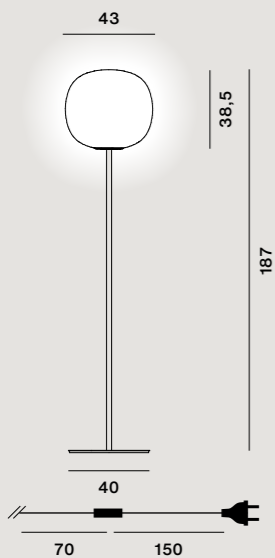

Collection →

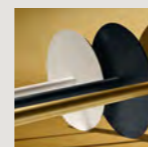
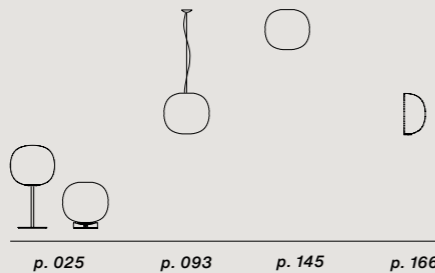

Ludovica + Roberto Palomba, 2007 - 2019



	colours	code	€
Gregg grande	bianco/bianco	FN168013EB_10	1.019,00
	oro/bianco	FN168013EG_10	1.201,00
	grafite/bianco	FN168013EN_10	
Gregg media	bianco/bianco	FN168003EB_10	722,00
	oro/bianco	FN168003EG_10	888,00
	grafite/bianco	FN168003EN_10	

Hand-blown cased acid-etched glass and coated metal

Glass colours: bianco

Weight: **Gregg grande** net kg 14,80

Light bulbs not included → specifications p. 196

Max 1x57W E27
Dimmer included

Transparent cable

☐ CE ⚡ IP 20



Please verify the compatibility of your bulb with the dimmer's wattage ranges, indicated on the dimmer itself, according to the kind of light source.

Frame colours: bianco, oro, grafite

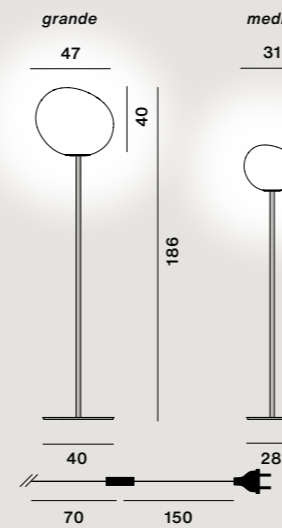

Collection →

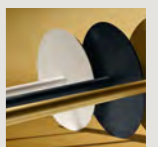
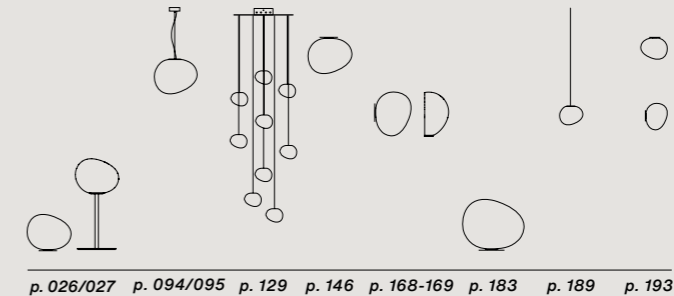

Havana

Terra / Floor

Jozeph Forakis, 1993



	colours	code	€
Havana on/off	alluminio/bianco	FN040003_10	401,00
	cromo/bianco	FN040003C_10	475,00
Havana with dimmer	alluminio/bianco	FN040003_10_D	421,00
	cromo/bianco	FN040003C_10_D	496,00

Injection moulded polyethylene and coated or chromed metal

Max 1x150W E27

Transparent cable

CE IP 20



Please verify the compatibility of your bulb with the dimmer's wattage ranges, indicated on the dimmer itself, according to the kind of light source.

Lampshade colours: bianco



Weight: net kg 3,30

Light bulbs not included → specifications p. 196

Frame colours: alluminio, cromo

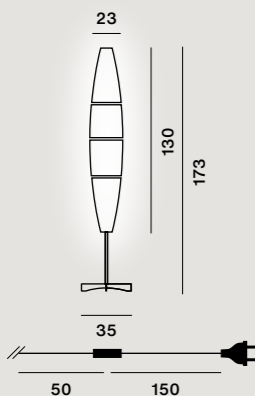

Collection →

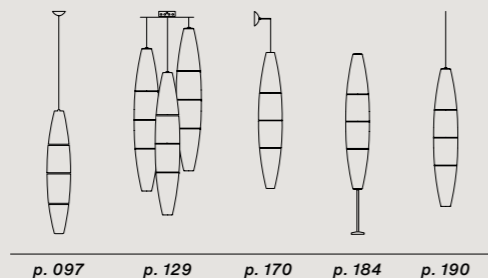

Cromo

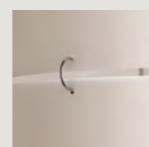

Alluminio

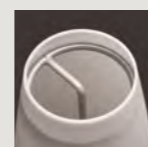

Lumiere XXL

Terra / Floor

Rodolfo Dordoni, 2015



	colours	code	€
Lumiere XXL	alluminio/bianco	FN191004A_11	1.415,00
	alluminio/grigio	FN191004A_24	
	cromo nero/bianco	FN191004C_11	
	cromo nero/grigio	FN191004C_24	

Hand-blown cased glass, coated or chromed aluminium and metal

Max 4x33W G9
Dimmer included

Transparent cable

CE IP 20



Please verify the compatibility of your bulb with the dimmer's wattage ranges, indicated on the dimmer itself, according to the kind of light source.

Glass colours: bianco, grigio freddo



Weight: net kg 16,5

Light bulbs not included → specifications p. 196

Frame colours: alluminio, cromo nero

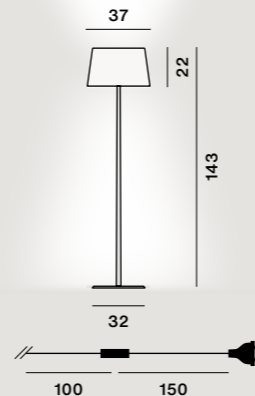

Collection →

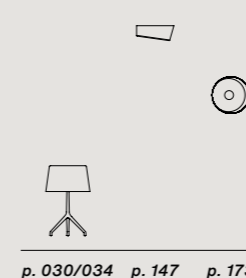

Giulio Iacchetti, 2011



	colours	code	€
Magneto	bianco	FN202004R3_10	541,00
	nero	FN202004R3_20	

Coated steel, ABS and super magnet made of "rare earth"

Colours: bianco, nero

Weight: net kg 2,80

This product contains an energy efficiency class G light source

LED included
5W 2700 K
475 lm CRI>80



Black cable

CE IP 20

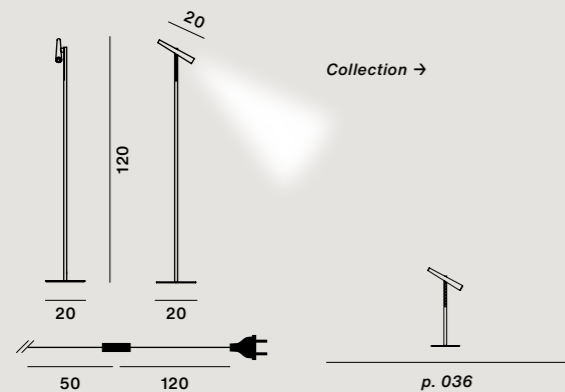

Marc Sadler, 2000 - 2021



	colours	code	€
Mite	nero	FN111003R3_20	1.085,00
	giallo	FN111003R3_55	1.139,00
Mite LED	nero	FN111003L1_20	1.478,00
	giallo	FN111003L1_55	1.552,00
Mite LED Anniversario	nero	FN111003L1_00	1.631,00

Fibreglass fabric with Kevlar or carbonium thread, nickelplated metal, steel and aluminium. Base in marquiña marble (Anniversario). Kevlar® is a Dupont registered trademark

Colours: nero, giallo

Weight: net kg 7,70

Mite LED
Contains an energy efficiency class E light source

Mite
Max 1x150W E27
Dimmer included

Mite Anniversario:
nero



Compasso D'Oro 2001

Please verify the compatibility of your bulb with the dimmer's wattage ranges, indicated on the dimmer itself, according to the kind of light source.

Mite LED
LED included
24W COB 2700 K
3530 lm CRI>90
Dimmer included

Transparent cable
Mite Anniversario black cable

CE IP 20 (LED)

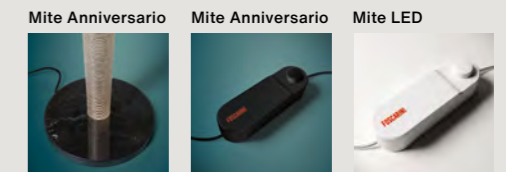
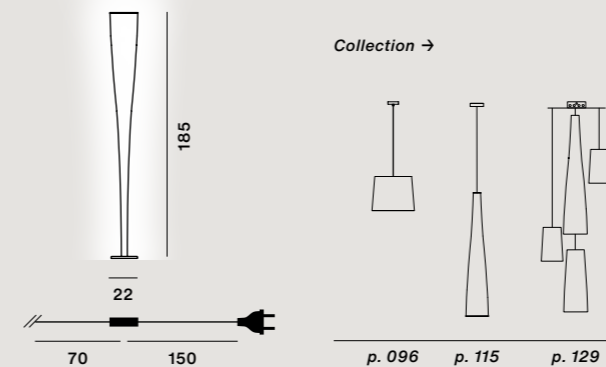

Orbital

Terra / Floor

Ferruccio Laviani, 1992



	colours	code	€
Orbital	bianco	FN036003_10	1.230,00
	colorato	FN036003	

Silkscreen-printed glass and lacquered metal

Colours: bianco, colorato

Weight: net kg 10,10

Light bulbs not included → specifications p. 196

Max 5x40W E14
Transparent cable



⚡ CE IP 20

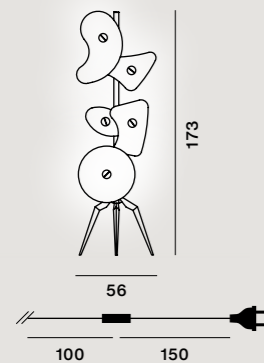

Collection →



p. 158



Rituals

Terra / Floor

Ludovica + Roberto Palomba, 2012 - 2019



	colours	code	€
Rituals 1 terra	bianco/bianco	FN244031EB_10	820,00
	oro/bianco	FN244031EG_10	990,00
	grafite/bianco	FN244031EN_10	
Rituals XL terra	bianco/bianco	FN244034EB_10	1.059,00
	oro/bianco	FN244034EG_10	1.246,00
	grafite/bianco	FN244034EN_10	

Hand-blown cased engraved satin glass and coated metal

Glass colours: bianco

Weight: **Rituals 1 terra** net kg 9,00

Light bulbs not included → specifications p. 196

Max 1x57W E27
Dimmer included



Transparent cable

Frame colours: bianco, oro, grafite

⚡ CE IP 20



Please verify the compatibility of your bulb with the dimmer's wattage ranges, indicated on the dimmer itself, according to the kind of light source.

Rituals 1 terra

24



70 150

Rituals XL terra

40

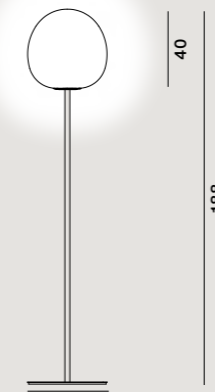

70 150

Collection →

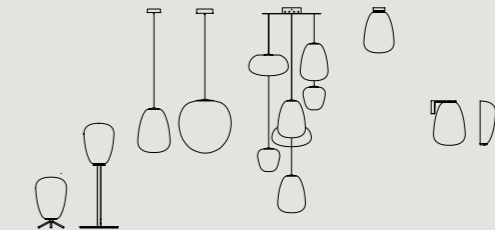

p. 040/041 p. 104/105 p. 129 p. 148 p. 174-175

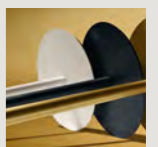

Ferruccio Laviani, 2019

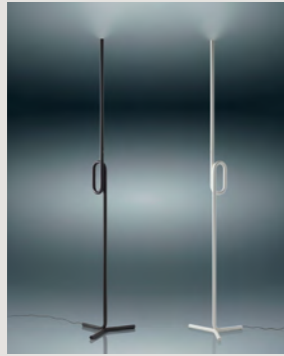

	colours	code	€
Tobia	bianco	FN294003D_10	856,00
	nero	FN294003D_20	
	arancio	FN294003D_53	914,00
	giallo	FN294003D_55	
	oro	FN294003D_71	1.409,00

Liquid varnished or gold painted metal and aluminum

Colours: bianco, nero, arancio, giallo, oro

Weight: net kg 3,80

This product contains an energy efficiency class F light source

LED included
15W 2700 K 2000 lm
CRI > 80
Integrated touch dimmer

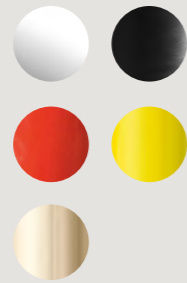

Black cable

☐ CE IP 20

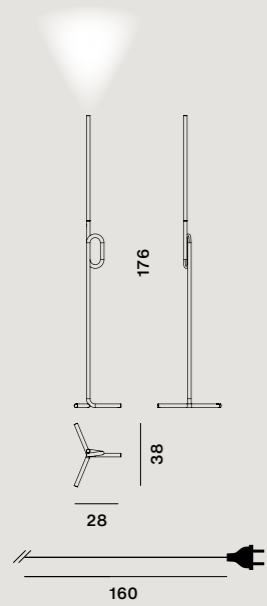

Collection →



p. 177

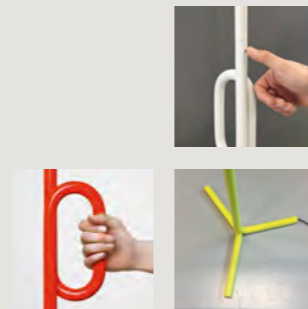

Marc Sadler, 2008 - 2011

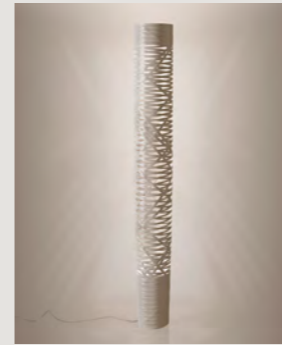

	colours	code	€
Tress grande	bianco	FN182003S_10	1.722,00
	nero	FN182003S_20	
	greige	FN182003S_25	
Tress grande LED	bianco	FN182003L_10	2.305,00
	nero	FN182003L_20	
	greige	FN182003L_25	
Tress media	bianco	FN182004_10	926,00
	nero	FN182004_20	
	greige	FN182004_25	

Compound material on lacquered fibre base, coated metal and aluminium

Colours: bianco, nero, greige

Weight: **Tress grande** net kg 8,50

Tress grande LED
Contains an energy efficiency class E + E light source

Tress grande
Max 1x250W R7s
+ 100W E27 PAR 30
Double switch
Black cable

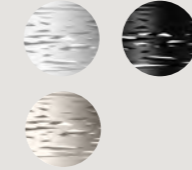

Tress media
net kg 3,90

Tress grande e media
Light bulbs not included
→ specifications p. 196

Tress grande LED LED
LED included
56W 2700 K
5624 lm CRI>90
Double switch
Transparent cable

☐ CE IP 20

Tress media
Max 1x100W E27 PAR 30

☐ CE IP 20

Dimmer included
Transparent cable



Please verify the compatibility of your bulb with the dimmer's wattage ranges, indicated on the dimmer itself, according to the kind of light source.

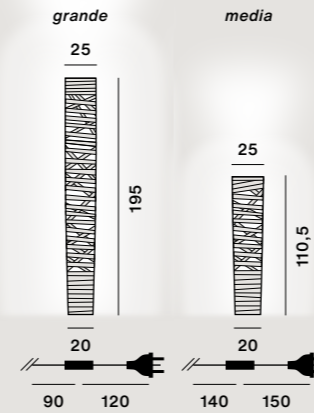

Collection →

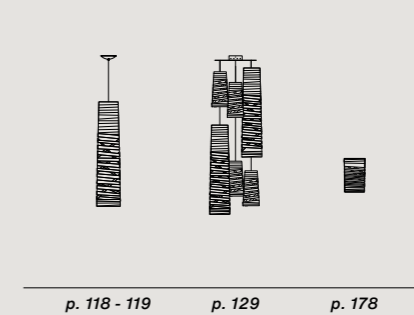

p. 118 - 119

p. 129

p. 178

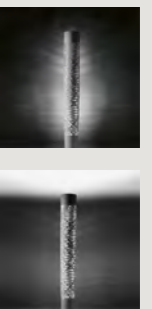

Ferruccio Laviani, 2013

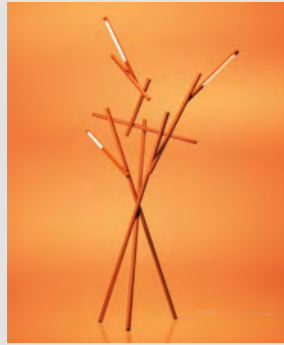

	colours	code	€
Tuareg	arancio	FN255003_53	3.569,00
	**bianco	FN255003_10	
	cromo nero	FN255003_78	4.017,00

Varnished aluminium and polycarbonate

Colours: bianco, arancio, cromo nero

Weight: net kg 9,20

This product contains an energy efficiency class F light source

** Limited stock available

LED included
46W 3000 K
4560 lm CRI > 90
3 separate switches and integrated touch dimmer orientable lights

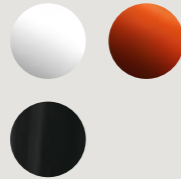

Transparent cable

CE IP 20

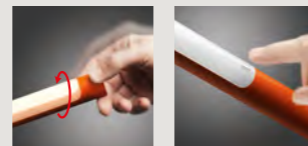
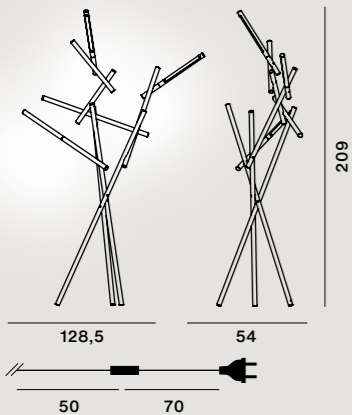

Marc Sadler, 2015



	colours	code	€
Twice as Twiggy *	bianco	FN275013_10	7.634,00
	nero	FN275013_20	
	greige	FN275013_25	
	cremisi	FN275013_67	
	** indaco	FN275013_87	

Coated fibreglass-based composite material, PMMA, polycarbonate, coated metal and aluminium

Colours: bianco, nero, greige, cremisi, indaco

Weight: net kg 57,60

This product contains an energy efficiency class F light source

* **On demand:** lead times to be checked with the sales department

** Limited stock available

LED included
81W 3000 K
8517 lm CRI>90
Dimmer included



Transparent cable

CE IP 20

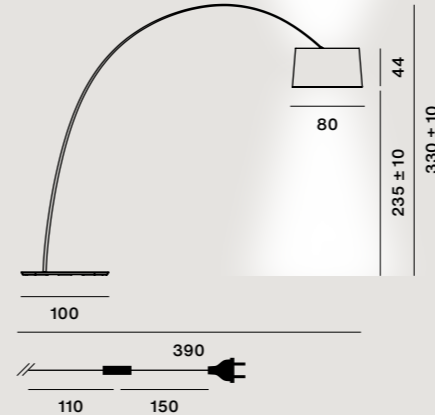

Collection →

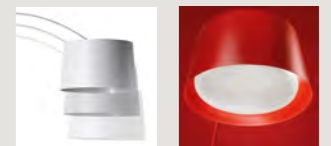

p. 121

Marc Sadler, 2006



	colours	code	€
Twiggy	bianco	FN159003_10	1.518,00
	nero	FN159003_20	
	greige	FN159003_25	
	cremisi	FN159003_67	
	grafite	FN159003_22	

Accessories:

	colours	code	€
Additional stem set Twiggy (40 cm + 40 cm)	bianco	FN1590031_10	262,00
	nero	FN1590031_20	
	greige	FN1590031_25	
	cremisi	FN1590031_67	
	grafite	FN1590031_22	

Coated fibreglass-based composite material, PMMA, polycarbonate, coated metal and aluminium

Colours: bianco, nero, greige, cremisi, grafite

Weight: net kg 16,60

Light bulbs not included → specifications p. 196

Max 3x77W E27
Dimmer included

Transparent cable

☐ CE ⚡ IP 20



Please verify the compatibility of your bulb with the dimmer's wattage ranges, indicated on the dimmer itself, according to the kind of light source.

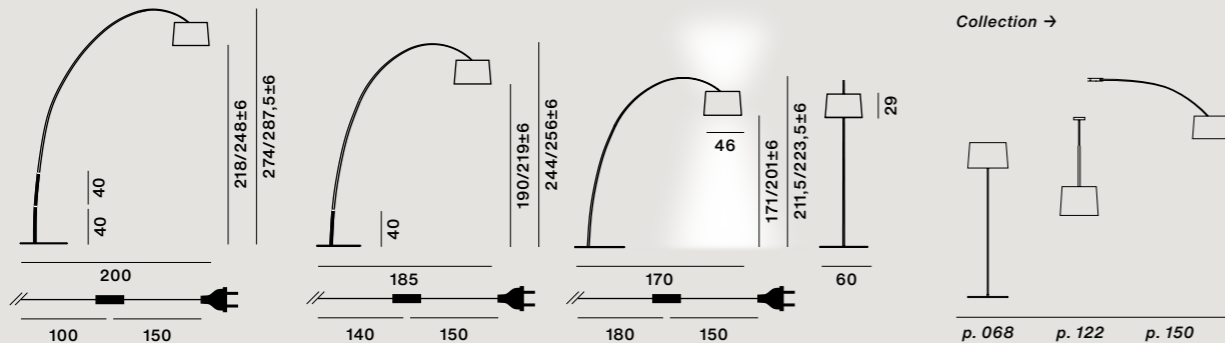

Marc Sadler, 2006 - 2019



	colours	code	€
Twiggy LED	bianco	FN159003L1_10	2.006,00
	nero	FN159003L1_20	
	greige	FN159003L1_25	
	cremisi	FN159003L1_67	
	grafite	FN159003L1_22	

	colours	code	€
Twiggy LED MyLight	bianco	FN159003M1_10	2.129,00
	nero	FN159003M1_20	
	greige	FN159003M1_25	
	cremisi	FN159003M1_67	
	grafite	FN159003M1_22	

	colours	code	€
Twiggy LED MyLight tunable white	bianco	FN159003T1_10	2.175,00
	nero	FN159003T1_20	
	greige	FN159003T1_25	
	cremisi	FN159003T1_67	
	grafite	FN159003T1_22	

Accessories:

	colours	code	€
Additional stem set Twiggy (40 cm + 40 cm)	bianco	FN1590031_10	262,00
	nero	FN1590031_20	
	greige	FN1590031_25	
	cremisi	FN1590031_67	
	grafite	FN1590031_22	

Coated fibreglass-based composite material, PMMA, polycarbonate, coated metal and aluminium

LED included
28W 2700 K 3840 lm CRI>90

Twiggy MyLight

Dimmable via Bluetooth with Casambi App ⌘

Twiggy MyLight tunable white
2700 - 5000 K

Dimmable via Bluetooth with Casambi App ⌘

Dimmer included

Transparent cable

☐ CE ⚡ IP 20

(⊕ tunable white)

Colours: bianco, nero, greige, cremisi, grafite

Weight: net kg 17,10

This product contains an energy efficiency class D light source



MyLight collection
→ specifications p. 194

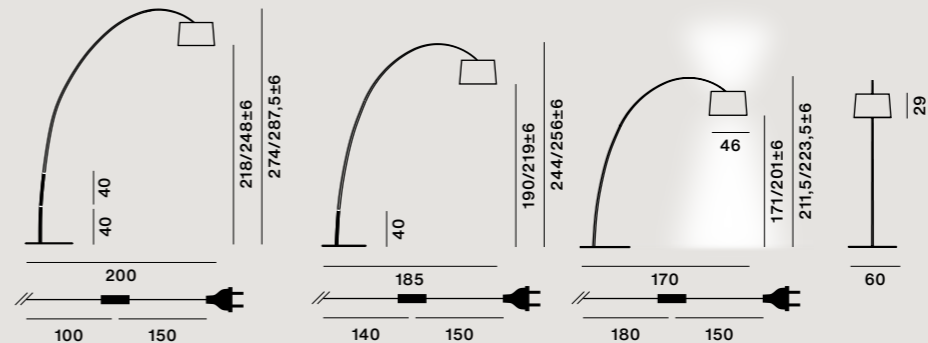

Twiggy Elle



Terra / Floor

Marc Sadler, 2006 - 2020



	colours	code	€
Twiggy Elle	bianco	FN159013_10	2.059,00
	nero	FN159013_20	
	greige	FN159013_25	
	cremisi	FN159013_67	
	grafite	FN159013_22	
Twiggy Elle MyLight	bianco	FN159013ML_10	2.209,00
	nero	FN159013ML_20	
	greige	FN159013ML_25	
	cremisi	FN159013ML_67	
	grafite	FN159013ML_22	
Twiggy Elle MyLight tunable white	bianco	FN159013TW_10	2.255,00
	nero	FN159013TW_20	
	greige	FN159013TW_25	
	cremisi	FN159013TW_67	
	grafite	FN159013TW_22	

Coated fibreglass-based composite material, PMMA, polycarbonate, coated metal and aluminium

LED included
28W 2700 K 3840 lm CRI>90

Twiggy MyLight
Dimmable via Bluetooth with Casambi App 📱

Twiggy MyLight tunable white
2700 - 5000 K
Dimmable via Bluetooth with Casambi App 📱

Dimmer included

Transparent cable

CE IP 20

(☺ tunable white)

Colours:
bianco, nero, greige,
cremisi, grafite



Weight:
net kg 17,10

This product contains an energy efficiency class D light source

MyLight collection
→ specifications p. 194

Collection →

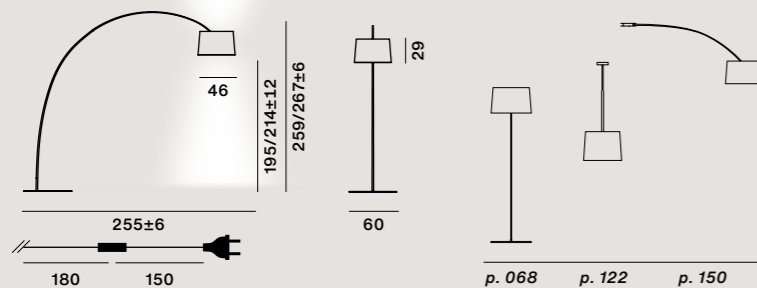

p. 068 p. 122 p. 150

Twiggy Wood



Terra / Floor

Marc Sadler, 2006 - 2020



	colours	code	€
Twiggy Wood	nero	FN159003W1_50	2.006,00
	greige	FN159003W2_50	
Twiggy Wood MyLight	nero	FN159003WM1_50	2.129,00
	greige	FN159003WM2_50	
Twiggy Wood MyLight tunable white	nero	FN159003WT1_50	2.175,00
	greige	FN159003WT2_50	
Twiggy Elle Wood	nero	FN159013W1_50	2.059,00
	greige	FN159013W2_50	
Twiggy Elle Wood MyLight	nero	FN159013WM1_50	2.209,00
	greige	FN159013WM2_50	
Twiggy Elle Wood MyLight tunable white	nero	FN159013WT1_50	2.255,00
	greige	FN159013WT2_50	

Limed oak wood, fibreglass coated with composite material, PMMA, polycarbonate and aluminium

LED included
28W 2700 K 3840 lm CRI>90

Twiggy MyLight
Dimmable via Bluetooth with Casambi App 📱

Twiggy MyLight tunable white
2700 - 5000 K
Dimmable via Bluetooth with Casambi App 📱

Dimmer included

Transparent cable

CE IP 20

(☺ tunable white)

Diffuser colours:
oak



Frame colours:
nero, greige



Weight:
net kg 17,10

This product contains an energy efficiency class D light source

MyLight collection
→ specifications p. 194

Twiggy Elle

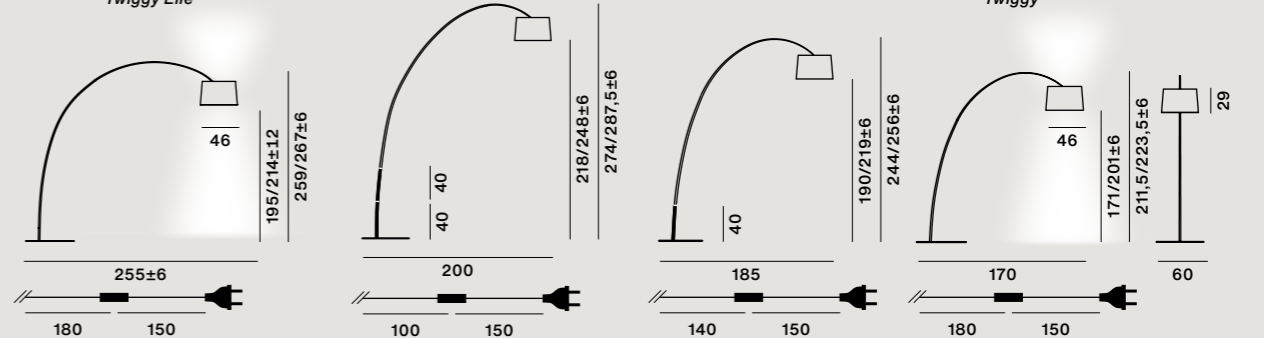

Twiggy Lettura

Terra / Floor

Marc Sadler, 2008



	colours	code	€
Twiggy lettura	bianco	FN159004_10	1.296,00
	nero	FN159004_20	

Coated fibreglass-based composite material, PMMA, polycarbonate and coated metal

Max 3x77W E27
Dimmer included

Transparent cable

☐ CE IP 20



Please verify the compatibility of your bulb with the dimmer's wattage ranges, indicated on the dimmer itself, according to the kind of light source.

Colours:
bianco, nero



Weight:
net kg 11,30

Light bulbs not included
→ specifications p. 196

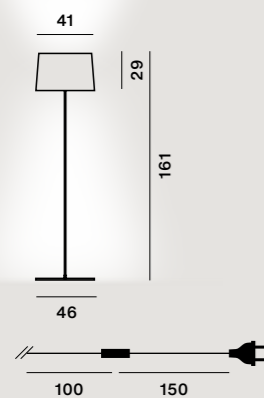

Collection →

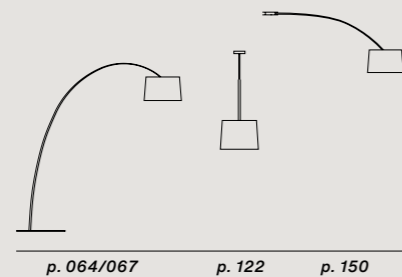

Uptown

LED

Terra / Floor

Ferruccio Laviani, 2019



	colours	code	€
Uptown *	giallo/rosso/blu	FN296003_01	4.184,00

Serigraphed tempered glass, PMMA and stainless steel

Colours:
giallo/rosso/blu



Weight:
net kg 22,00

This product contains an energy efficiency class D light source

*

On demand:
lead times to be checked with the sales department

LED included
17,7W 2700 K
2498 lm CRI>80
Dimmer included

Transparent cable

☐ CE IP 20

Wooden crate packaging

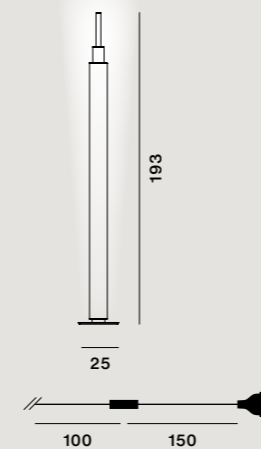

Caboche Plus

Patricia Urquiola con Eliana Gerotto

→ Technical info p. 084



Index

Sospensione / Suspension

072	Allegretto	100	Nuée
073	Allegro	101	Plena
074	Aplomb	102	Plass grande
075	Aplomb Large	103	Plass media
076	Aplomb mini	104	Rituals + Rituals XL
078	Big Bang	106	Satellight
079	Big Bang L + XL	108	Spokes 1 - 3
080	Birdie	109	Spokes 2 + MIDI + Large
082	Buds	110	Spokes
081	Bump	111	Spokes 2 piccola
084	Caboche Plus grande	112	Sun-Light of Love
085	Caboche Plus media	113	Supernova
086	Caboche Plus piccola	114	Tartan
088	Chouchin	115	Tite
089	Chouchin bianco	116	Tonda
090	Chouchin Reverse	118	Tress
092	Dolmen	119	Tress grande
093	Gem	120	Troag
096	Giga-Lite	122	Twiggy
094	Gregg	123	Twiggy Wood
097	Havana	121	Twice as Twiggy
098	Le Soleil	124	Uto
099	Lightweight		

Atelier Oi, 2009



	colours	code	€
<i>Allegretto Ritmico</i>	grafite	FN1690171_20	1.991,00
<i>Allegretto Vivace</i>	rame	FN1690172_80	2.384,00
<i>Allegretto Assai</i>	oro	FN1690173_71	2.733,00
<i>Allegretto Ritmico h. 10 m *</i>	grafite	FN1690171-10_20	2.207,00
<i>Allegretto Vivace h. 10 m *</i>	rame	FN1690172-10_80	2.600,00
<i>Allegretto Assai h. 10 m *</i>	oro	FN1690173-10_71	2.949,00

Varnished aluminium and metal

Max 2x100W E27 PAR 30

⊕ CE IP 20

Colours:

Allegretto Ritmico grafite,
Allegretto Vivace rame,
Allegretto Assai oro

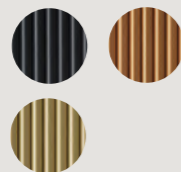

Weight:

Allegretto Ritmico
net kg 5,10

Allegretto Vivace
net kg 9,10

Allegretto Assai
net kg 11,30

Light bulbs not included
→ specifications p. 196

Decentralization
→ specifications p. 135

*
On demand:
lead times to be checked
with the sales department

Ritmico

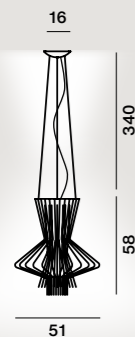

Vivace

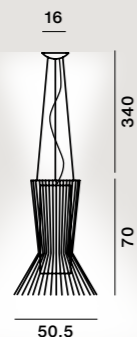

Assai

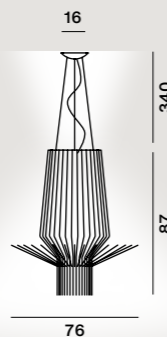

Atelier Oi, 2007



	colours	code	€
<i>Allegro Ritmico LED</i>	grafite	FN1690071L_20	3.859,00
<i>Allegro Vivace LED</i>	rame	FN1690072L_80	4.981,00
<i>Allegro Assai LED</i>	oro	FN1690073L_71	7.292,00
<i>Allegro Ritmico</i>	grafite	FN1690071_20	3.412,00
<i>Allegro Vivace</i>	rame	FN1690072_80	4.533,00
<i>Allegro Assai</i>	oro	FN1690073_71	6.845,00
<i>Allegro Ritmico LED h. 10 m *</i>	grafite	FN1690071L-1020	4.059,00
<i>Allegro Vivace LED h. 10 m *</i>	rame	FN1690072L-1080	5.181,00
<i>Allegro Assai LED h. 10 m *</i>	oro	FN1690073L-1071	7.492,00
<i>Allegro Ritmico h. 10 m *</i>	grafite	FN1690071-10_20	3.577,00
<i>Allegro Vivace h. 10 m *</i>	rame	FN1690072-10_80	4.699,00
<i>Allegro Assai h. 10 m *</i>	oro	FN1690073-10_71	7.011,00

Varnished aluminium and metal

Allegro LED included 
51W 3000 K
5684 lm CRI>90
Dimmable
Possible configurations:
On-Off/Push/DALI

Allegro
Max 1x300W R7s +
1x100W E27 PAR 30

Double switch

⊕ CE IP 20

Colours:

Allegro Ritmico grafite,
Allegro Vivace rame,
Allegro Assai oro

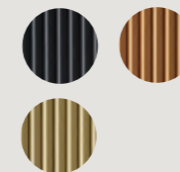

Weight:

Allegro Ritmico
net kg 15,00

Allegro Vivace
net kg 19,30

Allegro Assai
net kg 36,00

Allegro LED

This product contains an energy
efficiency class G + E light source

Allegro
Light bulbs not included
→ specifications p. 196

Decentralization
→ specifications p. 135

LED and dimming
→ specifications p. 195

*

On demand:
lead times to be checked with the
sales department

Ritmico

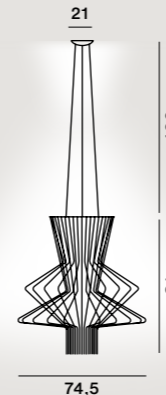

Vivace

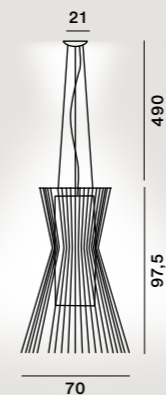

Assai

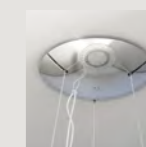
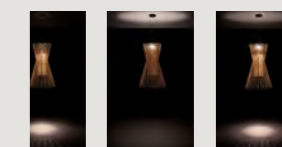
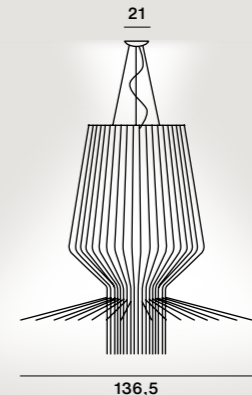

Lucidi e Pevere, 2010



Hand pouring concrete and aluminium

Aplomb GU10
Max 1x8W PAR 16

Aplomb G9 **
Max 1x60W

Cable color
white/white
other colours /black
Anthracite version
anthracite support

⊕ CE IP 20

	colours	code	€
Aplomb GU10	bianco	FN195007L-3_10	407,00
	grigio	FN195007L-3_25	
	antracite	FN195007L-3_27	
	marrone	FN195007L-3_52	
	verde	FN195007L-3_43	
	giallo	FN195007L-3_56	
	rosso	FN195007L-3_64	
Aplomb GU10 h. 10 m *	bianco	FN195007L-10_10	468,00
	grigio	FN195007L-10_25	
	antracite	FN195007L-10_27	
	marrone	FN195007L-10_52	
	verde	FN195007L-10_43	
	giallo	FN195007L-10_56	
	rosso	FN195007L-10_64	
Aplomb G9 **	marrone	FN195007R1_52	407,00

Colours:
bianco,
grigio cemento,
antracite, marrone,
verde oliva,
giallo sabbia,
rosso mattone

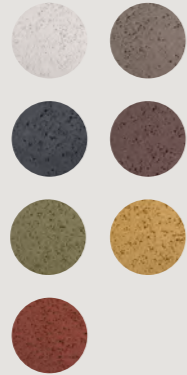

Weight:
net kg 1,90

*
On demand:
lead times to be
checked with the
sales department

**
Limited stock
available

Light bulbs not included
→ specifications p. 196

Multiple canopy
→ specifications p. 129

Decentralization
→ specifications p. 135

Collection →

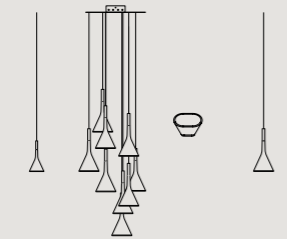

p. 076 p. 129 p. 154 p. 188

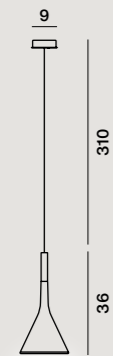
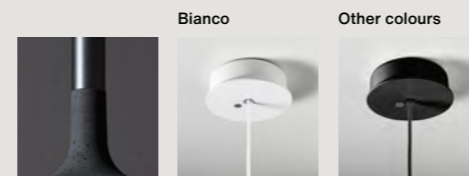

17

Lucidi e Pevere, 2016



Hand pouring concrete, aluminium and polycarbonate

LED Included
11,7W 2700K
1279 lm CRI>90
Dimmable LED version
Possible configurations:
On-Off/Push/DALI

Version MyLight
Dimmable via Bluetooth
with Casambi App ☞

Cable color
white / white
other colours / black

⊕ CE IP 20

	colours	code	€
Aplomb Large	bianco	FN195017_10	669,00
	grigio	FN195017_25	
	antracite	FN195017_27	
	marrone	FN195017_52	
Aplomb Large dimmerabile	grigio	FN195017D_25	731,00
	antracite	FN195017D_27	
Aplomb Large MyLight *	grigio	FN195017ML_25	890,00
	antracite	FN195017ML_27	
Aplomb Large h. 10 m *	bianco	FN195017-10_10	706,00
	grigio	FN195017-10_25	
	antracite	FN195017-10_27	
	marrone	FN195017-10_52	
Aplomb Large dimmerabile h. 10 m *	grigio	FN195017D-10_25	768,00
	antracite	FN195017D-10_27	
Aplomb Large MyLight * h. 10 m *	grigio	FN195017ML-10_25	
	marrone	FN195017ML-10_52	

Colours:
bianco,
grigio cemento,
antracite, marrone

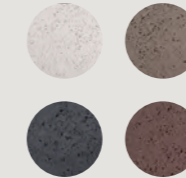

Weight:
net kg 4,00

*
On demand:
lead times to be
checked with the
sales department

This product contains an energy efficiency class F light source

Decentralization
→ specifications p. 135

LED and dimming
→ specifications p. 195

MyLight collection
→ specifications p. 194



45

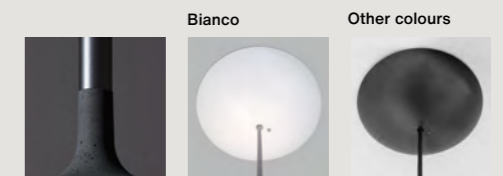

Aplomb mini

Sospensione / Suspension

Lucidi e Pevere, 2015



	colours	code	€
Aplomb mini	bianco	FN195027R1_10	295,00
	grigio	FN195027R1_25	
	antracite	FN195027R1_27	
	marrone	FN195027R1_52	
Aplomb mini h. 10 m *	bianco	FN195027R1-1010	355,00
	grigio	FN195027R1-1025	
	antracite	FN195027R1-1027	
	marrone	FN195027R1-1052	

Hand pouring concrete and aluminium

Max 1x8W PAR 16

Cable color
white / white
other colours / black

⊕ CE IP 20

Colours:
bianco,
grigio cemento,
antracite, marrone

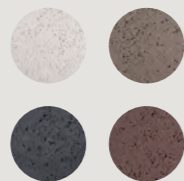

Weight:
net kg 0,70

*

On demand:
lead times to be
checked with the
sales department

Light bulbs not included
→ specifications p. 196

Multiple canopy
→ specifications p. 129

Decentralization
→ specifications p. 135

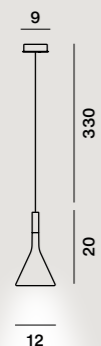

12

Collection →

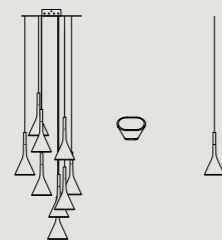

p. 129 p. 154 p. 188

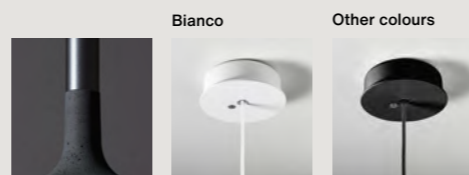

Aplomb antracite Lucidi e Pevere



Enrico Franzolini con Vicente Garcia Jimenez, 2005



	colours	code	€
Big Bang LED	bianco	FN151007L_10	1.477,00
	rosso	FN151007L_63	1.634,00
Big Bang LED dimmable	bianco	FN151007LD_10	1.591,00
	rosso	FN151007LD_63	1.748,00
Big Bang	bianco	FN151007_10	884,00
	rosso	FN151007_63	1.041,00
Big Bang LED h. 10 m *	bianco	FN151007L-10_10	1.610,00
	rosso	FN151007L-10_63	1.767,00
Big Bang LED dimmable h. 10 m *	bianco	FN151007LD10_10	1.724,00
	rosso	FN151007LD10_63	1.881,00
Big Bang h. 10 m *	bianco	FN151007_10SP10	1.017,00
	rosso	FN151007_63SP10	1.175,00

Methacrylate and coated aluminium

Big Bang LED included 
 37W 3000 K
 3260 lm CRI>90
 Dimmable LED version
 Possible configurations:
 On-Off/Push/DALI

Big Bang
 Max 1x160W R7s

  IP 20

Colours:
 bianco, rosso



Weight:
Big Bang LED
 net kg 7,40

Big Bang
 net kg 5,40

*
On demand:
 lead times to be
 checked with the
 sales department

Big Bang LED
 This product contains an energy
 efficiency class F light source

Big Bang
 Light bulbs not included
 → specifications p. 196

Decentralization
 → specifications p. 135

LED and dimming
 → specifications p. 195

Collection →

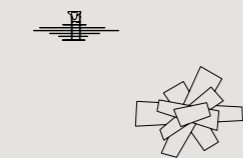
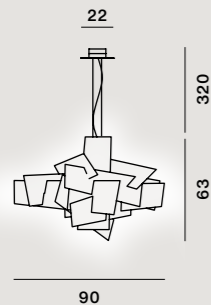

p. 139 p. 156

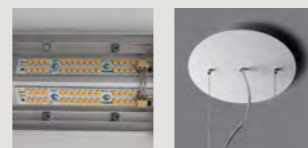

Enrico Franzolini con Vicente Garcia Jimenez, 2005-2016



	colours	code	€
Big Bang L	bianco	FN151017_10	3.037,00
	rosso	FN151017_63	3.220,00
Big Bang XL	bianco	FN1510072L_10	4.866,00
	rosso	FN1510072L_63	5.605,00
Big Bang L h. 10 m *	bianco	FN151017-10_10	3.144,00
	rosso	FN151017-10_63	3.327,00
Big Bang XL h. 10 m *	bianco	FN1510072L-1010	4.973,00
	rosso	FN1510072L-1063	5.712,00

Methacrylate and coated aluminium

Big Bang L LED included
 58W 3000 K
 6084 lm CRI>90
 Dimmable
 Possible configurations:
 On-Off/Push/DALI

Big Bang XL LED included
 87W 3000 K
 9126 lm CRI>90
 Dimmable
 Possible configurations:
 On-Off/Push/DALI

  IP 20

Colours:
 bianco, rosso



Weight:
Big Bang L
 net kg 21,00

Big Bang XL
 net kg 37,70

*
On demand:
 lead times to be
 checked with the
 sales department

This product contains an energy
 efficiency class F light source

Light bulbs not included
 → specifications p. 196

Decentralization
 → specifications p. 135

LED and dimming
 → specifications p. 195

Big Bang L

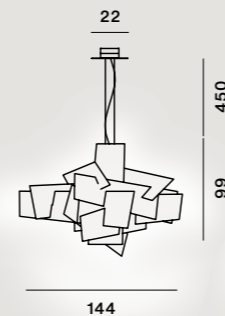

Big Bang XL

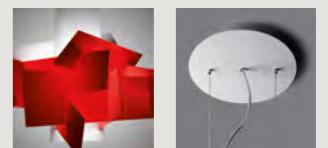
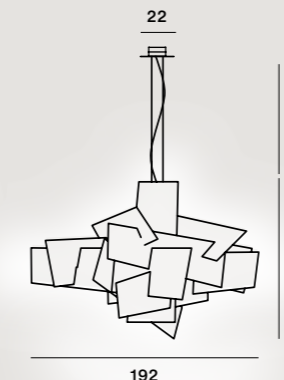

Birdie

Sospensione / Suspension

Ludovica + Roberto Palomba, 2013



	colours	code	€
Birdie grande	bianco	FN221017_10	286,00
	grigio	FN221017_25	
Birdie piccola	bianco	FN221027_10	246,00
	grigio	FN221027_25	
Birdie grande h. 10 m *	bianco	FN221017-10_10	362,00
	grigio	FN221017-10_25	
Birdie piccola h. 10 m *	bianco	FN221027-10_10	322,00
	grigio	FN221027-10_25	

Polycarbonate and varnished metal

Colours:
bianco, grigio



Weight:
Birdie grande
net kg 1,30

Birdie piccola
net kg 1,00

*
On demand:
lead times to be
checked with the
sales department

Light bulbs not included
→ specifications p. 196

Multiple canopy
→ specifications p. 129

Decentralization
→ specifications p. 135

Birdie grande
Max 1x150W E27

Birdie piccola
Max 1x70W E27

⚡ CE IP 20

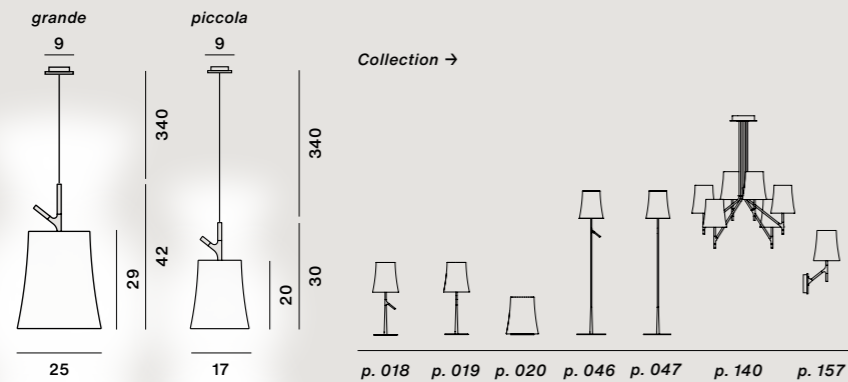

Bump

Sospensione / Suspension

Ludovica + Roberto Palomba, 2020



	colours	code	€
Bump	frost	FN312007_16	337,00
	oro	FN312007_71	393,00
	petrolio	FN312007_86	
	nero	FN312007_20	
Bump h. 10 m *	frost	FN312007-10_16	371,00
	oro	FN312007-10_71	428,00
	petrolio	FN312007-10_86	
	nero	FN312007-10_20	

Liquid coated and moulded
PMMA or ABS

Colours:
frost, oro, petrolio, nero

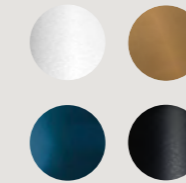

Weight:
net kg 2,10

Light bulbs not included
→ specifications p. 196

Max 1x30W E27

⚡ CE IP 20

Black version
Black cable - black canopy

Other colours
Trasparent cable - white
canopy

*
On demand:
lead times to be
checked with the
sales department

Decentralization
→ specifications p. 135

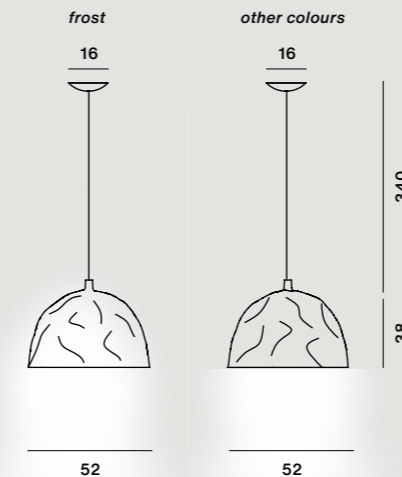

Buds



Sospensione / Suspension

Rodolfo Dordoni, 2016



Hand-blown cased glass

Buds 1-2-3

LED retrofit included
21W E27 2700 K
2500 lm CRI>80
Dimmable with
TRIAC technology

Buds 1-2-3 LED included

23,9W COB 2700 K
2581 lm CRI>90
Dimmable version
Possible configurations:
On-Off/Push/DALI

CE IP 20

	colours	code	€
Buds 1	bianco caldo	FN278071E_12	694,00
Buds 2	bianco caldo	FN278072E_12	735,00
	grigio	FN278072E_24	
Buds 3	bianco caldo	FN278073E_12	656,00
	verde	FN278073E_40	
Buds 1 LED	bianco caldo	FN278071L_12	843,00
Buds 2 LED	bianco caldo	FN278072L_12	884,00
	grigio	FN278072L_24	
Buds 3 LED	bianco caldo	FN278073L_12	803,00
	verde	FN278073L_40	
Buds 1 LED dimmable	bianco caldo	FN278071LD_12	919,00
Buds 2 LED dimmable	bianco caldo	FN278072LD_12	960,00
	grigio	FN278072LD_24	
Buds 3 LED dimmable	bianco caldo	FN278073LD_12	881,00
	verde	FN278073LD_40	

Colours:

Buds 1 bianco caldo
Buds 2 bianco caldo,
grigio
Buds 3 bianco caldo,
verde bambù



Weight:

Buds 1
net kg 3,60

Buds 2
net kg 4,90

Buds 3
net kg 2,90

Buds 1 LED
net kg 4,20

Buds 2 LED
net kg 5,50

Buds 3 LED
net kg 3,50

Buds LED

This product contains an energy
efficiency class E light source

Multiple canopy
→ specifications p. 129

Decentralization
→ specifications p. 135

LED and dimming
→ specifications p. 195

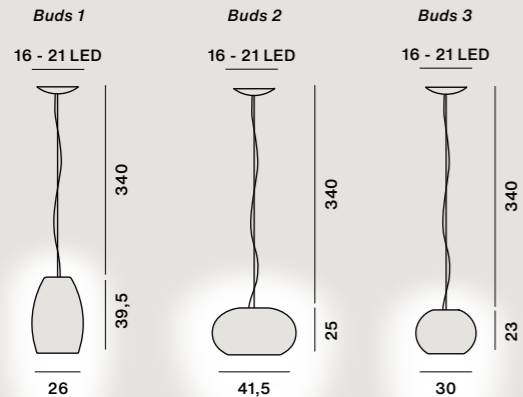

Collection →

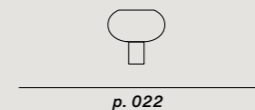

Buds

Sospensione / Suspension

Rodolfo Dordoni, 2016

	colours	code	€
Buds 1 h. 10 m *	bianco caldo	FN278071E-10_12	754,00
Buds 2 h. 10 m *	bianco caldo	FN278072E-10_12	796,00
	grigio	FN278072E-10_24	
Buds 3 h. 10 m *	bianco caldo	FN278073E-10_12	716,00
	verde	FN278073E-10_40	
Buds 1 LED h. 10 m *	bianco caldo	FN278071L-10_12	901,00
Buds 2 LED h. 10 m *	bianco caldo	FN278072L-10_12	941,00
	grigio	FN278072L-10_24	
Buds 3 LED h. 10 m *	bianco caldo	FN278073L-10_12	862,00
	verde	FN278073L-10_40	
Buds 1 LED dimm. h. 10 m *	bianco caldo	FN278071LD-1012	978,00
Buds 2 LED dimm. h. 10 m *	bianco caldo	FN278072LD-1012	1.019,00
	grigio	FN278072LD-1024	
Buds 3 LED dimm. h. 10 m *	bianco caldo	FN278073LD-1012	939,00
	verde	FN278073LD-1040	

*

On demand:
lead times to be checked
with the sales department



Patricia Urquiola con Eliana Gerotto, 2005-2021



	colours	code	€
<i>Caboche Plus grande</i>	trasparente	FN311017_16	2.850,00
	grigio	FN311017_25	
<i>Caboche Plus grande dimmable</i>	trasparente	FN311017D_16	2.961,00
	grigio	FN311017D_25	
<i>Caboche Plus grande MyLight</i>	trasparente	FN311017ML_16	2.961,00
	grigio	FN311017ML_25	
<i>Caboche Plus grande MyLight Tunable White</i>	trasparente	FN311017TW_16	3.024,00
	grigio	FN311017TW_25	
<i>Caboche Plus grande h. 10 m *</i>	trasparente	FN311017-10_16	3.163,00
	grigio	FN311017-10_25	
<i>Caboche Plus grande dimmable h. 10 m *</i>	trasparente	FN311017D-10_16	3.274,00
	grigio	FN311017D-10_25	
<i>Caboche Plus grande MyLight h. 10 m *</i>	trasparente	FN311017ML-1016	3.274,00
	grigio	FN311017ML-1025	
<i>Caboche Plus grande MyLight Tunable White h. 10 m *</i>	trasparente	FN311017TW-1016	3.337,00
	grigio	FN311017TW-1025	

PMMA, steel, polycarbonate and aluminium

Caboche Plus grande LED included
28W 2700 K
3850 lm CRI>90
Dimmable version
Possible configurations:
On-Off/Push/DALI

Colours:
trasparente, grigio



Weight:
net kg 17,00

This product contains an energy efficiency class E light source

Decentralization
→ specifications p. 135

LED and dimming
→ specifications p. 195

MyLight collection
→ specifications p. 194

*
On demand:
lead times to be checked with the sales department

Assembly tutorial:



tutorial.foscarini.com/CabochePlus

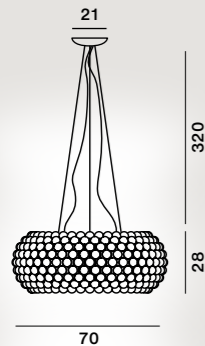

Collection →

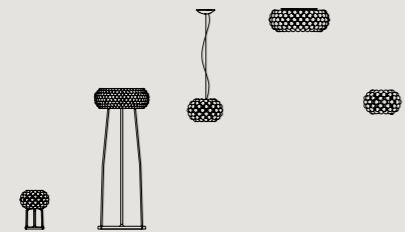

p. 023 p. 048 p. 084-086 p. 141 p. 159

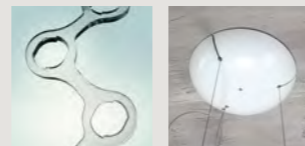

Patricia Urquiola con Eliana Gerotto, 2005-2021



	colours	code	€
<i>Caboche Plus media LED</i>	trasparente	FN311007_16	1.571,00
	grigio	FN311007_25	
<i>Caboche Plus media LED dimmable</i>	trasparente	FN311007D_16	1.683,00
	grigio	FN311007D_25	
<i>Caboche Plus media R7s</i>	trasparente	FN138007R1_16	1.194,00
	grigio	FN138007R1_25	
<i>Caboche Plus media MyLight</i>	trasparente	FN311007ML_16	1.683,00
	grigio	FN311007ML_25	
<i>Caboche Plus media MyLight Tunable White</i>	trasparente	FN311007TW_16	1.727,00
	grigio	FN311007TW_25	
<i>Caboche Plus media LED h. 10 m *</i>	trasparente	FN311007-10_16	1.690,00
	grigio	FN311007-10_25	
<i>Caboche Plus media LED dimmable h. 10 m *</i>	trasparente	FN311007D-10_16	1.802,00
	grigio	FN311007D-10_25	
<i>Caboche Plus media R7s h. 10 m *</i>	trasparente	FN138007R1-1016	1.390,00
	grigio	FN138007R1-1025	
<i>Caboche Plus media MyLight h. 10 m *</i>	trasparente	FN311007ML-1016	1.802,00
	grigio	FN311007ML-1025	
<i>Caboche Plus media MyLight Tunable White h. 10 m *</i>	trasparente	FN311007TW-1016	1.845,00
	grigio	FN311007TW-1025	

PMMA, steel, polycarbonate, aluminium, blown glass (R7s)

Caboche Plus media LED included
23W 2700 K
3200 lm CRI>90
Dimmable version
Possible configurations:
On-Off/Push/DALI

Colours:
trasparente, grigio



Weight:
net kg 10,20

Caboche Plus LED
This product contains an energy efficiency class E light source

MyLight version
Dimmable via Bluetooth with Casambi App

*
On demand:
lead times to be checked with the sales department

Caboche Plus R7s
Light bulbs not included
→ specifications p. 196

Decentralization
→ specifications p. 135

LED and dimming
→ specifications p. 195

MyLight collection
→ specifications p. 194

*
On demand:
lead times to be checked with the sales department

MyLight version Tunable White
2700-5000 K

⊕ Ⓢ IP 20

Caboche Plus media
Max 1x160W R7s

⊕ Ⓢ IP 20

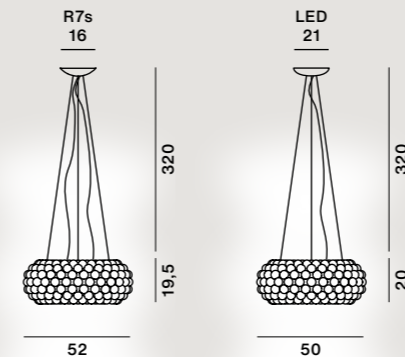

Patricia Urquiola con Eliana Gerotto, 2005-2021



	colours	code	€
<i>Caboche Plus piccola</i>	trasparente	FN311027_16	733,00
<i>on/off</i>	grigio	FN311027_25	
<i>Caboche Plus piccola</i>	trasparente	FN311027-10_16	877,00
<i>h. 10 m*</i>	grigio	FN311027-10_25	

PMMA, steel, polycarbonate and aluminium

LED included
7W 2700 K
1000 lm CRI>90

⊕ CE IP 20

Colours:
trasparente, grigio

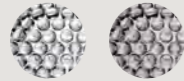

Weight:
net kg 4,80

This product contains an energy efficiency class D light source

Decentralization
→ specifications p. 135

*
On demand:
lead times to be checked with
the sales department



31

Collection →

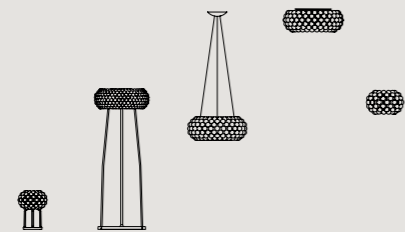

p. 023 p. 048 p. 084/085 p. 141 p. 159

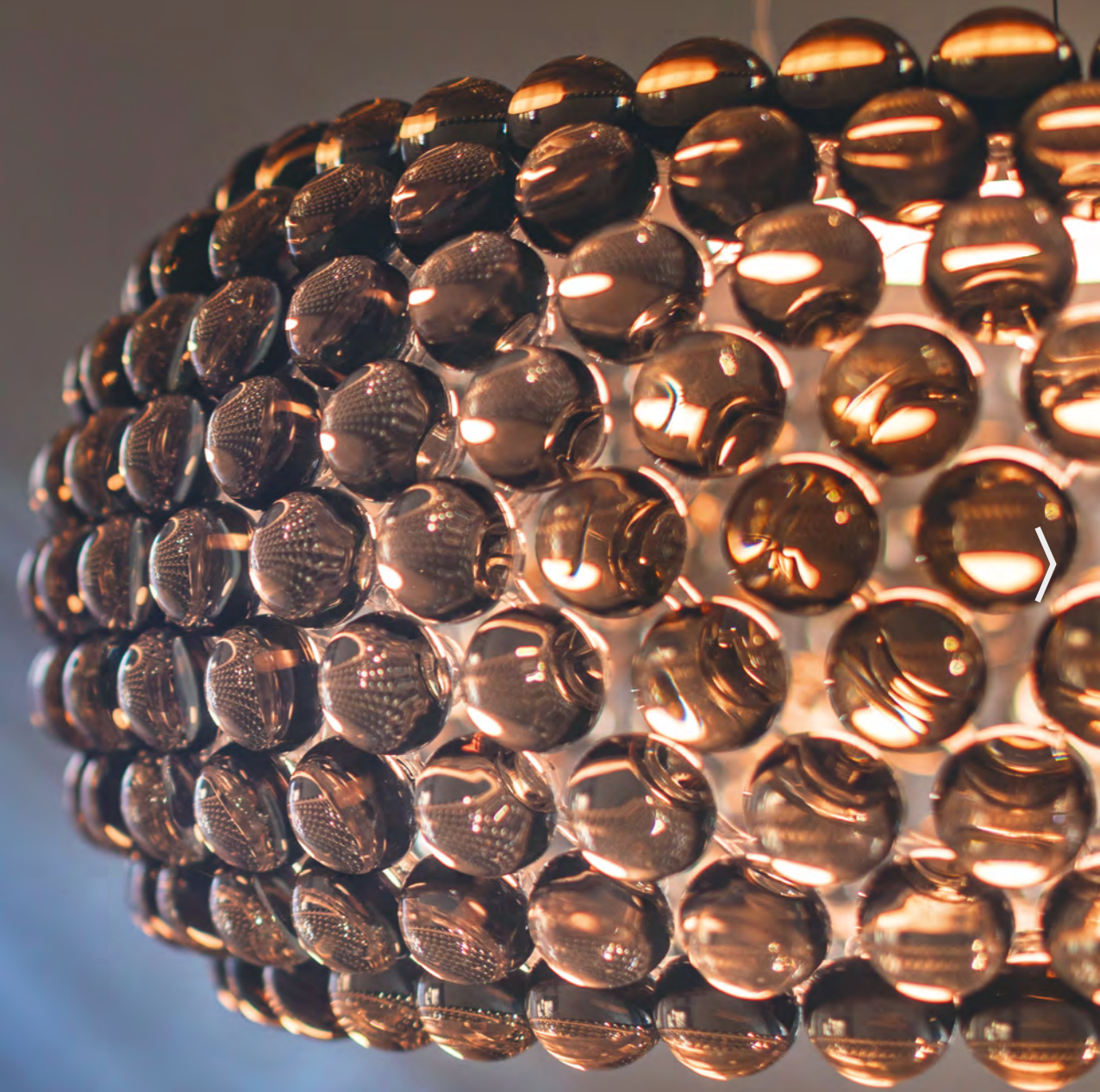



Ionna Vautrin, 2011



Lacquered hand-blown cased glass

Chouchin 1 - 2 - 3
LED retrofit included
21W E27 2700 K
2451 lm CRI>80
Dimmable with TRIAC technology

Chouchin 1 - 2 - 3 LED
included 24W COB
2700 K 2581 lm CRI>90
Dimmable LED version
Possible configurations:
On-Off/Push/DALI



	colours	code	€
Chouchin 1	arancio	FN210071E_53	702,00
Chouchin 2	verde	FN210072E_40	644,00
Chouchin 3	grigio	FN210073E_25	570,00
Chouchin 1 LED	arancio	FN210071L_53	850,00
Chouchin 2 LED	verde	FN210072L_40	794,00
Chouchin 3 LED	grigio	FN210073L_25	718,00
Chouchin 1 LED dimm.	arancio	FN210071LD_53	927,00
Chouchin 2 LED dimm.	verde	FN210072LD_40	871,00
Chouchin 3 LED dimm.	grigio	FN210073LD_25	795,00
Chouchin 1 h. 10 m *	arancio	FN210071E-10_53	762,00
Chouchin 2 h. 10 m *	verde	FN210072E-10_40	706,00
Chouchin 3 h. 10 m *	grigio	FN210073E-10_25	630,00
Chouchin 1 LED h. 10 m *	arancio	FN210071L-10_53	907,00
Chouchin 2 LED h. 10 m *	verde	FN210072L-10_40	851,00
Chouchin 3 LED h. 10 m *	grigio	FN210073L-10_25	775,00
Chouchin 1 LED dimm. h. 10 m *	arancio	FN210071LD-1053	984,00
Chouchin 2 LED dimm. h. 10 m *	verde	FN210072LD-1040	928,00
Chouchin 3 LED dimm. h. 10 m *	grigio	FN210073LD-1025	852,00

Colours:
Chouchin 1 arancio,
Chouchin 2 verde,
Chouchin 3 grigio



Weight:
Chouchin 1 net kg 4,40
Chouchin 2 net kg 2,90
Chouchin 3 net kg 3,60
Chouchin 1 LED net kg 5,00
Chouchin 2 LED net kg 3,50
Chouchin 3 LED net kg 4,20

Chouchin LED
This product contains an energy efficiency class E light source

Multiple canopy
→ specifications p. 129

Decentralization
→ specifications p. 135

LED and dimming
→ specifications p. 195

On demand:
lead times to be checked with the sales department

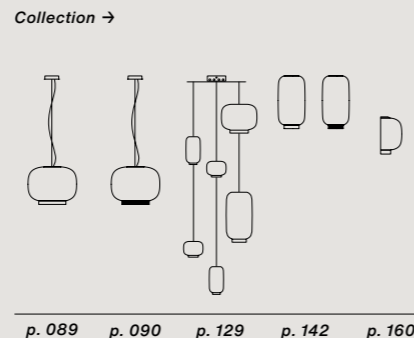
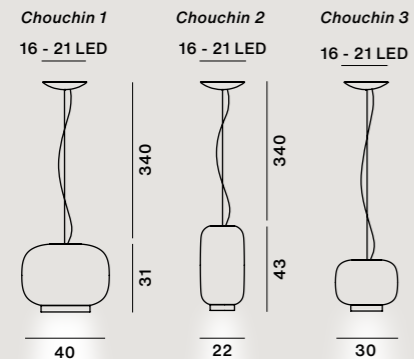

Ionna Vautrin, 2011



Hand-blown cased glass

Chouchin 1 - 2 - 3
LED retrofit included
21W E27 2700 K
2451 lm CRI>80
Dimmable with TRIAC technology

Chouchin 1 - 2 - 3 LED
included 24W COB
2700 K 2581 lm CRI>90
Dimmable LED version
Possible configurations:
On-Off/Push/DALI



	colours	code	€
Chouchin 1	bianco	FN210071E_11	610,00
Chouchin 2	bianco	FN210072E_11	566,00
Chouchin 3	bianco	FN210073E_11	494,00
Chouchin 1 LED	bianco	FN210071L_11	759,00
Chouchin 2 LED	bianco	FN210072L_11	715,00
Chouchin 3 LED	bianco	FN210073L_11	641,00
Chouchin 1 LED dimm.	bianco	FN210071LD_11	835,00
Chouchin 2 LED dimm.	bianco	FN210072LD_11	793,00
Chouchin 3 LED dimm.	bianco	FN210073LD_11	719,00
Chouchin 1 h. 10 m *	bianco	FN210071E-10_11	670,00
Chouchin 2 h. 10 m *	bianco	FN210072E-10_11	627,00
Chouchin 3 h. 10 m *	bianco	FN210073E-10_11	553,00
Chouchin 1 LED h. 10 m *	bianco	FN210071L-10_11	816,00
Chouchin 2 LED h. 10 m *	bianco	FN210072L-10_11	772,00
Chouchin 3 LED h. 10 m *	bianco	FN210073L-10_11	699,00
Chouchin 1 LED dimm. h. 10 m *	bianco	FN210071LD-1011	894,00
Chouchin 2 LED dimm. h. 10 m *	bianco	FN210072LD-1011	850,00
Chouchin 3 LED dimm. h. 10 m *	bianco	FN210073LD-1011	776,00

Colours:
bianco



Weight:
Chouchin 1 net kg 4,40
Chouchin 2 net kg 2,90
Chouchin 3 net kg 3,60
Chouchin 1 LED net kg 5,00
Chouchin 2 LED net kg 3,50
Chouchin 3 LED net kg 4,20

Chouchin LED
This product contains an energy efficiency class E light source

Multiple canopy
→ specifications p. 129

Decentralization
→ specifications p. 135

LED and dimming
→ specifications p. 195

On demand:
lead times to be checked with the sales department

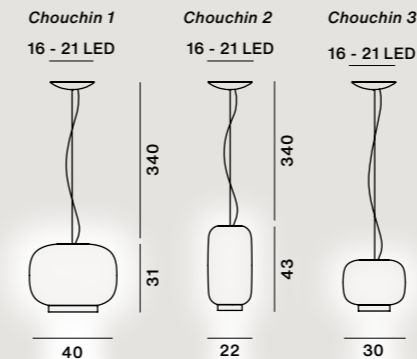



Ionna Vautrin, 2015



Lacquered hand-blown cased glass

Chouchin 1 - 2 - 3 reverse
LED retrofit included
21W E27 2700 K
2481 lm CRI>80
Dimmable with TRIAC technology

Chouchin 1 - 2 - 3 LED reverse
included 24W COB
2700 K 2581 lm CRI>90
Dimmable LED version
Possible configurations:
On-Off/Push/DALI

CE IP 20

	colours	code	€
Chouchin 1 Reverse	bianco/arancio	FN210071E_05	702,00
Chouchin 2 Reverse	bianco/verde	FN210072E_04	644,00
Chouchin 3 Reverse	bianco/grigio	FN210073E_02	570,00
Chouchin 1 Reverse LED	bianco/arancio	FN210071L_05	850,00
Chouchin 2 Reverse LED	bianco/verde	FN210072L_04	794,00
Chouchin 3 Reverse LED	bianco/grigio	FN210073L_02	718,00
Chouchin 1 Rev. LED dimm.	bianco/arancio	FN210071LD_05	927,00
Chouchin 2 Rev. LED dimm.	bianco/verde	FN210072LD_04	871,00
Chouchin 3 Rev. LED dimm.	bianco/grigio	FN210073LD_02	795,00
Chouchin 1 Rev. h. 10 m *	bianco/arancio	FN210071E-10_05	762,00
Chouchin 2 Rev. h. 10 m *	bianco/verde	FN210072E-10_04	706,00
Chouchin 3 Rev. h. 10 m *	bianco/grigio	FN210073E-10_02	630,00
Chouchin 1 Rev. LED h. 10 m *	bianco/arancio	FN210071L-10_05	907,00
Chouchin 2 Rev. LED h. 10 m *	bianco/verde	FN210072L-10_04	851,00
Chouchin 3 Rev. LED h. 10 m *	bianco/grigio	FN210073L-10_02	775,00
Chouchin 1 Rev. LED dimm. h. 10 m *	bianco/arancio	FN210071LD-1005	984,00
Chouchin 2 Rev. LED dimm. h. 10 m *	bianco/verde	FN210072LD-1004	928,00
Chouchin 3 Rev. LED dimm. h. 10 m *	bianco/grigio	FN210073LD-1002	852,00

Colours:

Chouchin reverse 1
bianco / arancio,
Chouchin reverse 2
bianco / verde,
Chouchin reverse 3
bianco / grigio

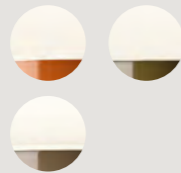

Weight:

Chouchin rev. 1
net kg 4,40

Chouchin rev. 2
net kg 2,90

Chouchin rev. 3
net kg 3,60

Chouchin rev. 1 LED
net kg 5,00

Chouchin rev. 2 LED
net kg 3,50

Chouchin rev. 3 LED
net kg 4,20

Chouchin LED

This product contains an energy efficiency class E light source

Multiple canopy
→ specifications p. 129

Decentralization
→ specifications p. 135

LED and dimming
→ specifications p. 195

*

On demand:
lead times to be checked with the sales department

Chouchin 1
16 - 21 LED

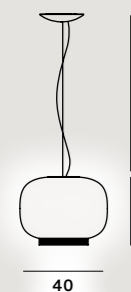

Chouchin 2
16 - 21 LED

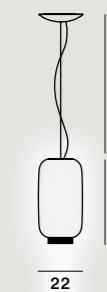

Chouchin 3
16 - 21 LED



Ionna Vautrin, 2015



Lacquered hand-blown cased glass

Chouchin 1 - 2 reverse
LED retrofit included
21W E27 2700 K
2481 lm CRI>80
Dimmable with TRIAC technology

Chouchin 1 - 2 LED reverse
included 24W COB
2700 K 2581 lm CRI>90
Dimmable LED version
Possible configurations:
On-Off/Push/DALI

CE IP 20

	colours	code	€
Chouchin 1 Reverse	bianco/oro	FN210071E_01	702,00
	**oro-bianco/oro	FN210071EG_01	759,00
Chouchin 2 Reverse	bianco/nero	FN210072E_03	644,00
	**grafite-bianco/nero	FN210072EN_03	703,00
Chouchin 1 Reverse LED	bianco/oro	FN210071L_01	850,00
Chouchin 2 Reverse LED	bianco/nero	FN210072L_03	794,00
Chouchin 1 Reverse LED dimm.	bianco/oro	FN210071LD_01	927,00
Chouchin 2 Reverse LED dimm.	bianco/nero	FN210072LD_03	871,00
Chouchin 1 Reverse h. 10 m *	bianco/oro	FN210071E-10_01	762,00
Chouchin 2 Reverse h. 10 m *	bianco/nero	FN210072E-10_03	706,00
Chouchin 1 Rev. LED h. 10 m *	bianco/oro	FN210071L-10_01	907,00
Chouchin 2 Rev. LED h. 10 m *	bianco/nero	FN210072L-10_03	851,00
Chouchin 1 Rev. LED dimm. h. 10 m *	bianco/oro	FN210071LD-1001	984,00
Chouchin 2 Rev. LED dimm. h. 10 m *	bianco/nero	FN210072LD-1003	928,00

Glass colours:

Chouchin Reverse 1
bianco / oro,
Chouchin Reverse 2
bianco / nero,



Frame colours:
bianco, oro, grafite



Weight:

Chouchin rev. 1
net kg 4,40

Chouchin rev. 2
net kg 2,90

Chouchin rev. 1 LED
net kg 5,00

Chouchin rev. 2 LED
net kg 3,50

Chouchin LED

This product contains an energy efficiency class E light source

Multiple canopy
→ specifications p. 129

Decentralization
→ specifications p. 135

LED and dimming
→ specifications p. 195

*

On demand:
lead times to be checked with the sales department

**

Limited stock available

Chouchin 1
16 - 21 LED



Chouchin 2
16 - 21 LED

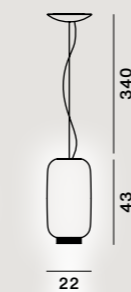

Collection →

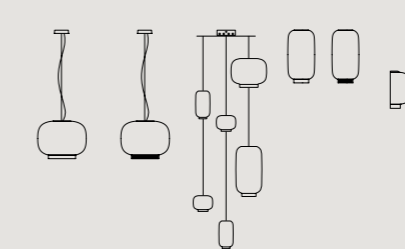

p. 088-089 p. 090 p. 129 p. 142 p. 160

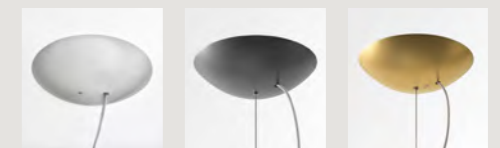

Ferruccio Laviani, 1996/2017



	colours	code	€
Dolmen **	**alluminio	FN280007_25	1.898,00
	**arancio	FN280007_14	

Anodised aluminium and PMMA

LED included
47W 2700 K
6486 lm CRI>90
Dimmable
Possible configurations:
On-Off/Push/DALI

⊕ CE IP 20

Colours:
alluminio, arancio



Weight:
net kg 12,50

This product contains an energy efficiency class E light source

LED and dimming
→ specifications p. 195

**
Limited stock available

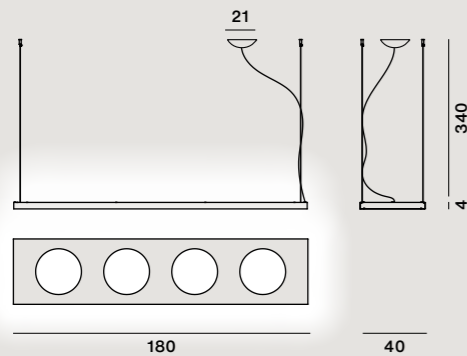

Collection →

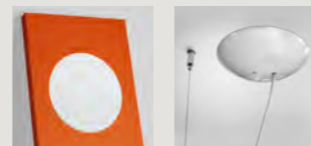
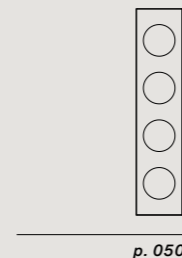

Ludovica + Roberto Palomba, 2017 - 2019



	colours	code	€
Gem	bianco	FN274007E_10	609,00
	**oro/bianco	FN274007EG_10	665,00
	**grafite/bianco	FN274007EN_10	
Gem LED	bianco	FN274007L_10	684,00
Gem LED dimmable	bianco	FN274007LD_10	760,00
Gem h. 10 m *	bianco	FN274007E10_10	669,00
Gem LED h. 10 m *	bianco	FN274007L-10_10	743,00
Gem LED dimm. h. 10 m *	bianco	FN274007LD-1010	816,00

Hand-blown cased acid-etched glass with reliefs

Gem
LED retrofit included
21W E27 2700 K
2451 lm CRI>80
Dimmable with TRIAC technology

Gem LED
included 24W COB 2700 K
2581 lm CRI>90
Dimmable version
Possible configurations:
On-Off/Push/DALI

⊕ CE IP 20

Glass colours:
bianco



Frame colours:
bianco, oro, grafite



Weight:
net kg 6,30

Gem LED
This product contains an energy efficiency class E light source

Multiple canopy
→ specifications p. 129

Decentralization
→ specifications p. 135

LED and dimming
→ specifications p. 195

*
On demand:
lead times to be checked with the sales department

**
Limited stock available

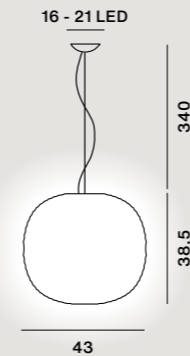

Collection →

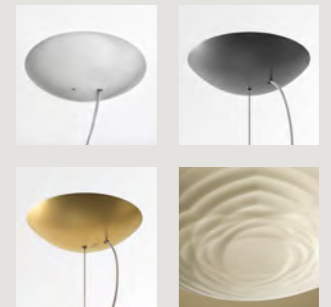
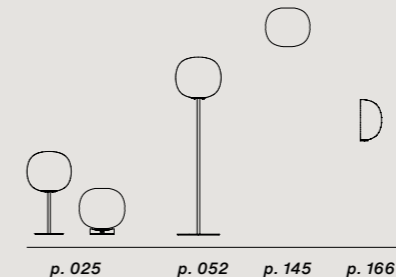

Ludovica + Roberto Palomba, 2007



	colours	code	€
Gregg grande	bianco	FN1680071E_10	695,00
	** oro/bianco	FN1680071EG_10	750,00
	** grafite/bianco	FN1680071EN_10	
Gregg grande MyLight	** bianco	FN1680071EML_10	813,00
	** oro/bianco	FN1680071EMG_10	868,00
	** grafite/bianco	FN1680071EMN_10	
Gregg media	bianco	FN168007E_10	431,00
	** oro/bianco	FN168007EG_10	486,00
	** grafite/bianco	FN168007EN_10	
Gregg media MyLight	** bianco	FN168007EML_10	549,00
	** oro/bianco	FN168007EMG_10	603,00
	** grafite/bianco	FN168007EMN_10	
Gregg midi	bianco	FN168037E_10	374,00
Gregg piccola	bianco	FN1680072R2_10	208,00

Hand-blown cased acid-etched glass

Gregg grande, media LED retrofit included
21W E27 2700 K
2451 lm CRI > 80
Dimmable with TRIAC technology

MyLight version
Dimmable via Bluetooth with Casambi device included

Gregg midi LED retrofit included
1x6,5W E14 2700K
806 lm CRI>80

Gregg piccola
Max 1x8W G9

Glass colours:
bianco



Frame colours:
bianco, oro, grafite



Weight:

Gregg grande
net kg 5,90

Gregg media
net kg 3,20

Gregg midi
net kg 1,60

Gregg piccola
net kg 0,70

Gregg grande LED
net kg 6,20

Gregg media LED
net kg 3,80

** Limited stock available

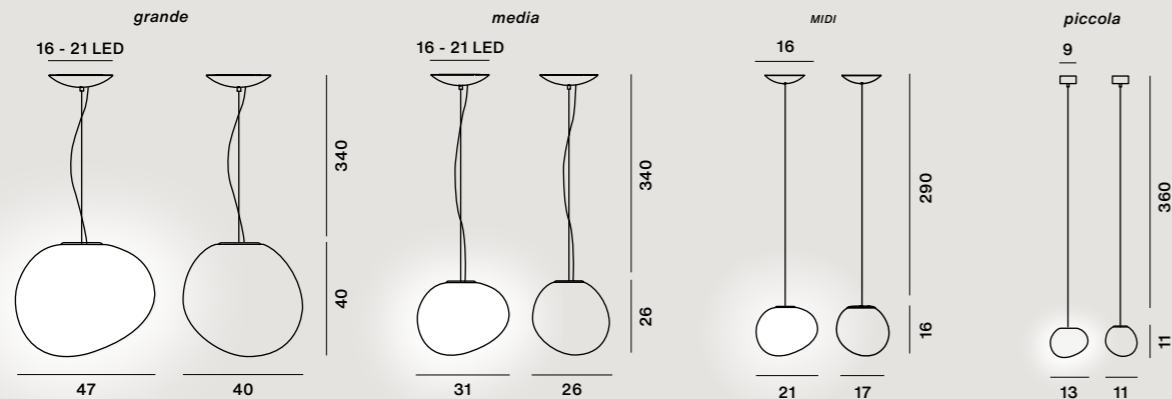

Ludovica + Roberto Palomba, 2007

	colours	code	€
Gregg grande LED	bianco	FN1680071L_10	774,00
Gregg grande LED dimm.	bianco	FN1680071LD_10	847,00
Gregg media LED	bianco	FN168007L_10	572,00
Gregg media LED dimm.	bianco	FN168007LD_10	645,00
Gregg grande h. 10 m *	bianco	FN1680071E10_10	754,00
Gregg media h. 10 m *	bianco	FN168007E-10_10	488,00
Gregg midi h. 10 m *	bianco	FN168037E10_10	407,00
Gregg piccola h. 10 m *	bianco	FN1680072R21010	296,00
Gregg grande LED h. 10 m *	bianco	FN1680071L-1010	627,00
Gregg grande LED h. 10 m dimm. *	bianco	FN1680071LD1010	701,00
Gregg media LED h. 10 m *	bianco	FN168007L-10_10	828,00
Gregg media LED h. 10 m dimm. *	bianco	FN168007LD-1010	902,00

Gregg grande/media LED
LED included
24W COB 2700 K
2581 lm CRI>90
Dimmable version
Possible configurations:
On-Off/Push/DALI
 IP 20

* On demand:
lead times to be checked
with the sales department

Gregg LED
This product contains an energy
efficiency class E light source

Multiple canopy
→ specifications p. 129

Decentralization
→ specifications p. 135

LED and dimming
→ specifications p. 195

MyLight collection
→ specifications p. 194

Collection →

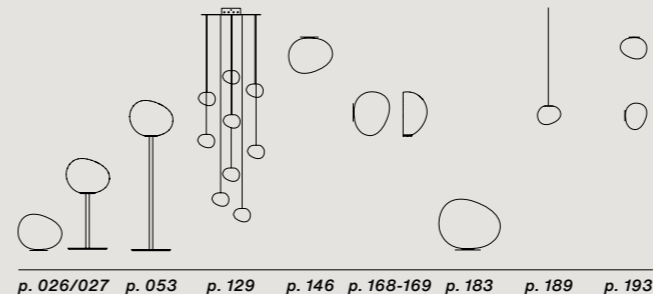

Giga-Lite

Sospensione / Suspension

Marc Sadler, 2004



	colours	code	€
Giga-Lite **	nero	FN139017_20	916,00

Fiberglass fabric with carbonium thread, steel and nickel-plated metal

Max 3x77W E27

⚡ CE IP 20

Colours: nero



Weight:
net kg 2,50

**
Limited stock
available

Light bulbs not included
→ specifications p. 196

Decentralization
→ specifications p. 135

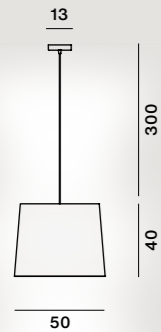

Collection →

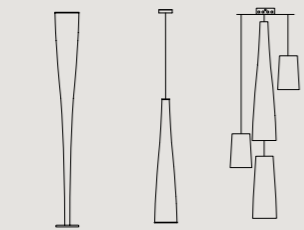

p. 057 p. 115 p. 129

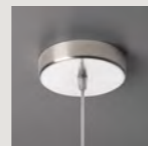

Havana

Sospensione / Suspension

Jozeph Forakis, 1993



	colours	code	€
Havana	bianco	FN0400072_R1_10	292,00
Havana h. 10 m *	bianco	FN0400072-10_10	390,00
Havana doppia 2x *	bianco	FN0400072SP2_10	1.227,00
Havana tripla 3x *	bianco	FN0400072SP3_10	1.779,00
Havana quadrupla 4x *	bianco	FN0400072SP4_10	2.331,00
Havana quintupla 5x *	bianco	FN0400072SP5_11	2.331,00

Injection moulded polyethylene and coated metal

Max 1x105W E27

⚡ CE IP 20

Havana doppia, tripla, quadrupla, quintupla

⚡ CE IP 20

Colours:
bianco



Weight:
net kg 1,90

*
On demand:
lead times to be
checked with the
sales department

Light bulbs not included
→ specifications p. 196

Multiple canopy
→ specifications p. 129

Decentralization
→ specifications p. 135

doppia tripla quadrupla quintupla

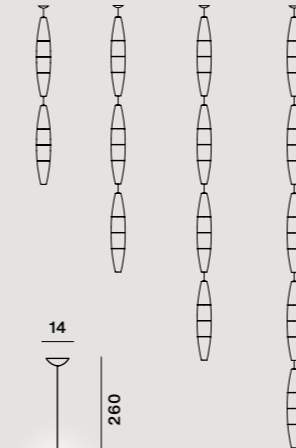

Collection →

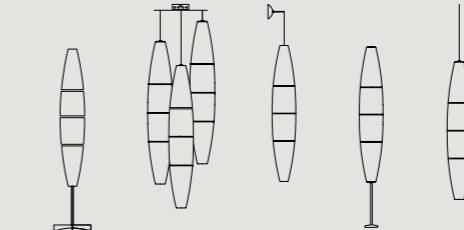

p. 054 p. 129 p. 170 p. 184 p. 190

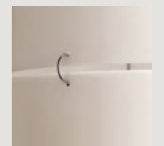
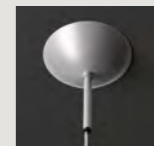

Le Soleil

Sospensione / Suspension

Vincente Garcia Jimenez, 2009



	colours	code	€
<i>Le Soleil</i>	bianco	FN181007_10	728,00
<i>Le Soleil LED</i>	bianco	FN181007L_10	763,00
<i>Le Soleil LED dimmable</i>	bianco	FN181007LD_10	878,00
<i>Le Soleil h. 10 m *</i>	bianco	FN181007-10_10	828,00
<i>Le Soleil LED h. 10 m *</i>	bianco	FN181007L-10_10	863,00
<i>Le Soleil LED dimm. h. 10 m *</i>	bianco	FN181007LD-1010	978,00

Injection moulded polycarbonate and coated metal

Le Soleil
Max 3x70W E27 +
1x75W GU10 PAR 16

Le Soleil LED 
included 46W 2700 K
4460 lm CRI>90
Dimmable

Possible configurations:
On-Off/Push/DALI

  IP 20

Colours:
bianco



Weight:
net kg 5,30

*
On demand:
lead times to be
checked with the
sales department

Le Soleil LED
This product contains an energy
efficiency class E light source

Light bulbs not included
→ specifications p. 196

Decentralization
→ specifications p. 135

LED and dimming
→ specifications p. 195

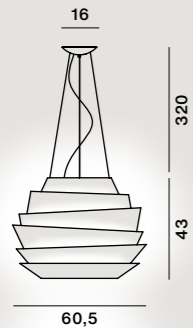

Collection →



p. 172

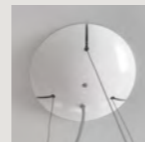

Lightweight

Sospensione / Suspension

Tom Dixon, 1995

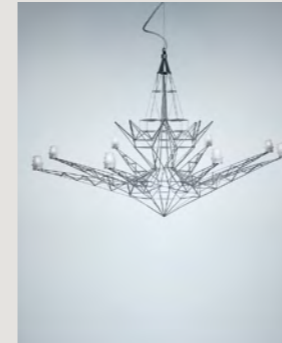

	colours	code	€
<i>Lightweight</i>	anodizzato	FN064007-R1_ZI	4.282,00
<i>Lightweight h. 10 m *</i>	anodizzato	FN064007_R1-10Z	4.603,00

Anodized metal

Max 8x2W G4 12V

  IP 20

Colours:
anodizzato



Weight:
net kg 7,60

*
On demand:
lead times to be
checked with the
sales department

Light bulbs not included
→ specifications p. 196

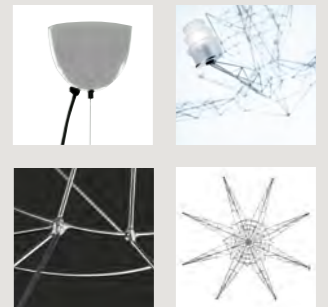
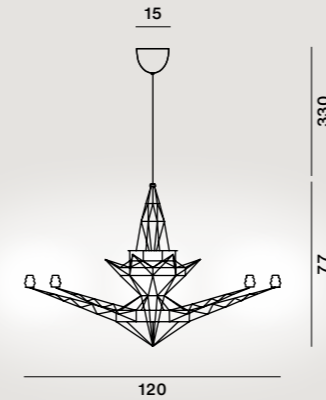

Marc Sadler, 2019



	colours	code	€
<i>Nuée</i>	bianco	FN309007_10	1.636,00
<i>Nuée MyLight</i>	bianco	FN309007ML_10	1.748,00
<i>Nuée h. 10 m *</i>	bianco	FN309007-10_10	1.722,00
<i>Nuée MyLight h. 10 m *</i>	bianco	FN309007ML-1010	1.833,00

Three-dimensional technical fabric and varnished metal

Colours:
bianco

Weight:
net kg 6,40

This product contains an energy efficiency class G + E light source

LED included
29W 3000 K
3749 lm CRI>90
Possible configurations:
On-Off/Push



LED and dimming
→ specifications p. 195

MyLight collection
→ specifications p. 194

*
On demand:
lead times to be checked with the sales department

MyLight version
Dimmable via Bluetooth with Casambi App

⊕ CE IP 20

Assembly tutorial:



tutorial.foscarini.com/nuee

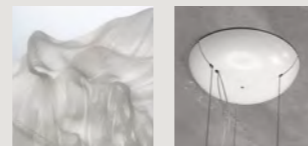
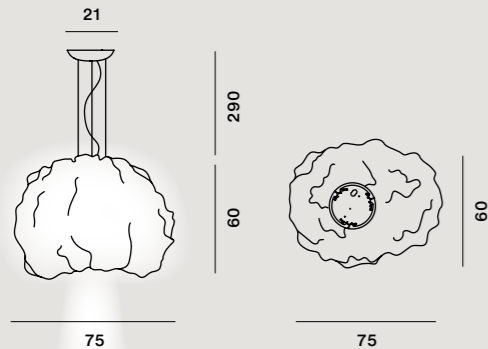

Eugenio Gargioni e Guillaume Albouy, 2017



	colours	code	€
<i>Plena</i>	bianco	FN283007_10	1.069,00
<i>Plena dimmable</i>	bianco	FN283007D_10	1.113,00
<i>Plena MyLight</i>	bianco	FN283007ML_10	1.113,00
<i>Plena h. 10 m *</i>	bianco	FN283007-10_10	1.151,00
<i>Plena dimmable h. 10 m *</i>	bianco	FN283007D-10_10	1.196,00
<i>Plena MyLight h. 10 m *</i>	bianco	FN283007ML-1010	1.196,00

Varnished PVC and aluminium

Colours:
bianco

Weight:
net kg 2,20

This product contains an energy efficiency class E light source

LED included
32 W 2700 K
3530 lm CRI>90



*
On demand:
lead times to be checked with the sales department

LED and dimming
→ specifications p. 195

MyLight collection
→ specifications p. 194

Dimmable version
Possible configurations:
On-Off/Push/DALI

MyLight version
Dimmable via Bluetooth with Casambi App

⊕ CE IP 20

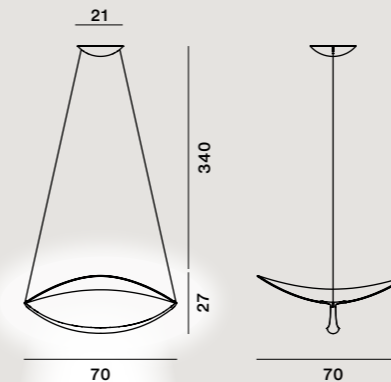

Plass grande

Sospensione / Suspension

Luca Nichetto, 2011



	colours	code	€
Plass grande LED	grigio	FN2240071L_25	3.674,00
Plass grande	grigio	FN2240071_25	3.249,00
Plass grande LED h. 10 m *	grigio	FN2240071L-1025	3.775,00
Plass grande h. 10 m *	grigio	FN2240071-10_25	3.342,00

Rotational moulded polycarbonate and aluminium

Colours: grigio

Weight: net kg 23,00

Plass grande LED
This product contains an energy efficiency class F light source

Plass grande LED included 
30W 3000 K
2500 lm CRI>80
+ LED retrofit included
1x9,5W 2700 K 650 lm
E27 PAR 30



*
On demand:
lead times to be checked with the sales department

Plass grande
Light bulbs not included
→ specifications p. 196

Decentralization
→ specifications p. 135

LED and dimming
→ specifications p. 195

Plass grande
Max 6x60W G9
+ 1x100W E27 PAR 30

Double switch



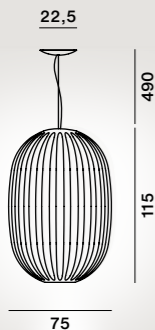

Collection →

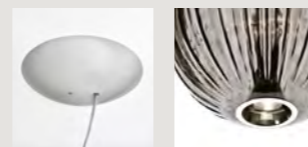
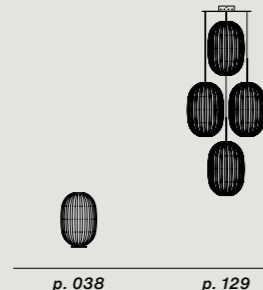

Plass media

Sospensione / Suspension

Luca Nichetto, 2015



	colours	code	€
Plass media E27+GU10	grigio	FN2240072_25	712,00
	azzurro	FN2240072_30	
Plass media E27	grigio	FN2240172_25	591,00
	azzurro	FN2240172_30	
Plass media E27+GU10 h.10 m*	grigio	FN2240072-10_25	829,00
	azzurro	FN2240072-10_30	
Plass media E27 h. 10 m *	grigio	FN2240172-10_25	709,00
	azzurro	FN2240172-10_30	
Plass media doppia *	grigio	FN2240072-2_25	1.480,00
	azzurro	FN2240072-2_30	
Plass media tripla *	grigio	FN2240072-3_25	2.122,00
	azzurro	FN2240072-3_30	
Plass media quadrupla *	grigio	FN2240072-4_25	2.764,00
	azzurro	FN2240072-4_30	
Plass media quintupla *	grigio	FN2240072-5_25	3.406,00
	azzurro	FN2240072-5_30	

Rotational moulded polycarbonate and steel

Colours: grigio, azzurro

Weight: net kg 3,50

Light bulbs not included
→ specifications p. 196

Plass media E27+GU10
Max 1x116W E27
+ 1x75W GU10 PAR 20

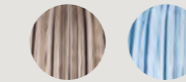

*
On demand:
lead times to be checked with the sales department

Multiple canopy
→ specifications p. 129

Plass media E27
Max 1x116W E27



Decentralization
→ specifications p. 135

doppia tripla quadrupla quintupla

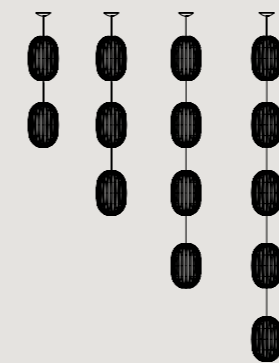

Ludovica + Roberto Palomba, 2013-2014



	colours	code	€
<i>Rituals 1</i>	bianco	FN2440071E_10	509,00
<i>Rituals 2</i>	bianco	FN2440072E_10	509,00
<i>Rituals 3</i>	bianco	FN2440073E_10	434,00
<i>Rituals XL</i>	bianco/bianco	FN2440074E_10	725,00
	** oro/bianco	FN2440074EG_10	782,00
	** grafite/bianco	FN2440074EN_10	782,00
<i>Rituals XL LED</i>	bianco	FN2440074L_10	794,00
<i>Rituals XL LED dimm.</i>	bianco	FN2440074LD_10	868,00

Hand-blown cased engraved satin glass and lacquered metal

Rituals 1-2-3
Max 1x70W E27

Rituals XL
LED retrofit included
21W E27 2700 K
2451 lm CRI > 80
Dimmable with TRIAC technology

Rituals XL LED
included 24W COB
2700 K 2581 lm CRI>90
Dimmable version
Possible configurations:
On-Off/Push/DALI

IP 20

Glass colours:
bianco



Frame colours XL:
bianco, oro, grafite

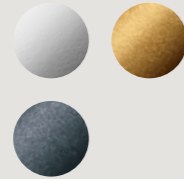

Weight:
Rituals 1
net kg 3,80

Rituals 2
net kg 4,00

Rituals 3
net kg 1,50

Rituals XL
net kg 6,30

Rituals XL LED
net kg 6,70

**
Limited stock available

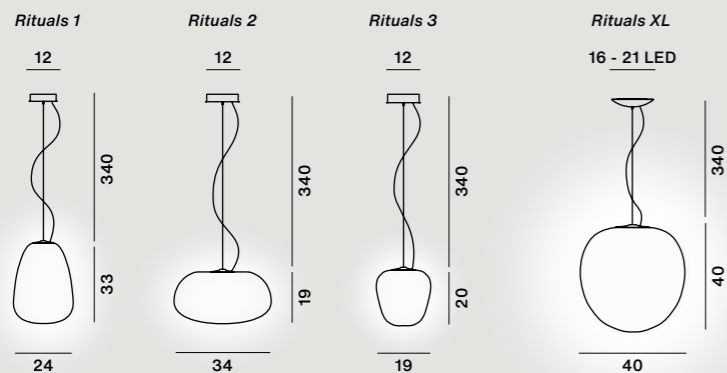

Ludovica + Roberto Palomba, 2013-2014

	colours	code	€
<i>Rituals 1 h. 10 m</i> *	bianco	FN2440071E-1010	597,00
<i>Rituals 2 h. 10 m</i> *	bianco	FN2440072E-1010	597,00
<i>Rituals 3 h. 10 m</i> *	bianco	FN2440073E-1010	522,00
<i>Rituals XL h. 10 m</i> *	bianco	FN2440074E10_10	785,00
<i>Rituals XL LED h. 10 m</i> *	bianco	FN2440074L-1010	850,00
<i>Rituals XL LED dimm. h. 10 m</i> *	bianco	FN2440074LD1010	926,00

*
On demand:
lead times to be checked
with the sales department

Rituals XL LED contains an energy efficiency class E light source

Light bulbs not included
→ specifications p. 196

Multiple canopy
→ specifications p. 129

Decentralization
→ specifications p. 135

LED and dimming
Rituals XL
→ specifications p. 195

Collection →

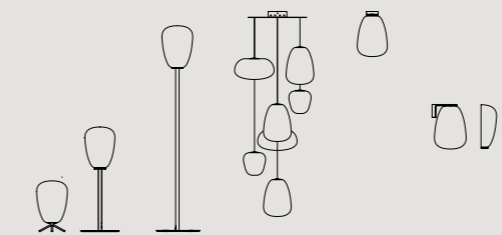

p. 040/041 p. 059 p. 129 p. 148 p. 174/175

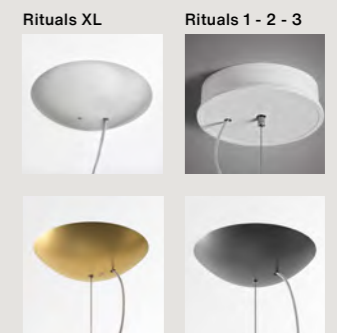

Eugeni Quitllet, 2017



	colours	code	€
Satellight	bianco/trasparente	FN285007-3_15	879,00
Satellight MyLight **	bianco/trasparente	FN285007ML_15	1.004,00
Satellight h. 10 m *	bianco/trasparente	FN285007-10_15	937,00

Hand-blown crystal glass and cased acid-etched glass

LED retrofit included
21W E27 2700 K
2451 lm CRI>80
Dimmable with TRIAC technology

MyLight version
Dimmable via Bluetooth with Casambi device included

⊕ CE IP 20

Colours: bianco/trasparente



Weight: net kg 5,50

*
On demand:
lead times to be checked with the sales department

**
Limited stock available

Multiple canopy → specifications p. 129

Decentralization → specifications p. 135

LED and dimming → specifications p. 195

MyLight collection → specifications p. 194

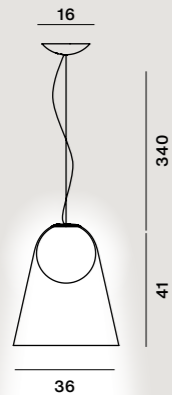

Collection →

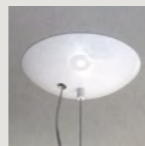
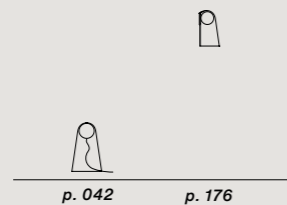

Spokes 1 - 3



Sospensione / Suspension

Garcia Cumini, 2014 - 2019



	colours	code	€
Spokes 1	bianco	FN2640071R1_10	1.161,00
	nero	FN2640071R1_20	1.252,00
	grafite	FN2640071R1_22	
	oro	FN2640071R1_71	
	rame	FN2640071R1_80	
Spokes 1 dimmable	bianco	FN2640071DR1_10	1.240,00
	nero	FN2640071DR1_20	1.330,00
	grafite	FN2640071DR1_22	
	oro	FN2640071DR1_71	
	rame	FN2640071DR1_80	
Spokes 1 MyLight	bianco	FN2640071ML_10	1.301,00
	nero	FN2640071ML_20	1.397,00
	grafite	FN2640071ML_22	
	oro	FN2640071ML_71	
	rame	FN2640071ML_80	
Spokes 3	bianco	FN2640073_10	1.141,00
	nero	FN2640073_20	1.230,00
	grafite	FN2640073_22	
	oro	FN2640073_71	
	rame	FN2640073_80	
Spokes 3 dimmable	bianco	FN2640073D_10	1.220,00
	nero	FN2640073D_20	1.309,00
	grafite	FN2640073D_22	
	oro	FN2640073D_71	
	rame	FN2640073D_80	
Spokes 3 MyLight	bianco	FN2640073ML_10	1.282,00
	nero	FN2640073ML_20	1.374,00
	grafite	FN2640073ML_22	
	oro	FN2640073ML_71	
	rame	FN2640073ML_80	

Varnished steel and aluminium

LED included
30W 2700 K
3316 lm CRI>90

Dimmable version
Possible configurations:
On-Off/Push/DALI

MyLight version
Dimmable via Bluetooth
with Casambi App

CE IP 20

Colours: bianco, nero, grafite, oro, rame

Weight:
Spokes 1
net kg 4,40

Spokes 3
net kg 4,00

This product contains an energy efficiency class E + E light source

LED and dimming
→ specifications p. 195

Decentralization
→ specifications p. 135

MyLight collection
→ specifications p. 194

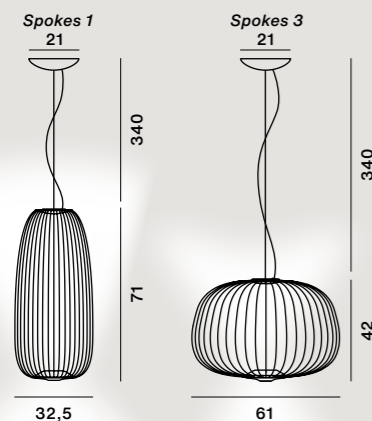

Spokes 2 - MIDI - Large



Sospensione / Suspension

Garcia Cumini, 2014 - 2019

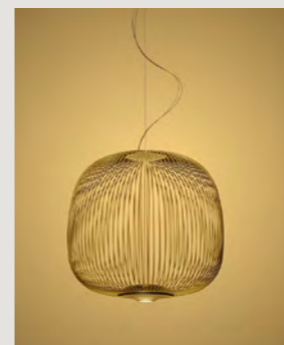

	colours	code	€
Spokes 2 MIDI	bianco	FN2640272_10	1.135,00
	nero	FN2640272_20	1.225,00
	grafite	FN2640272_22	
	oro	FN2640272_71	
	rame	FN2640272_80	
Spokes 2 MIDI dimmable	bianco	FN2640272D_10	1.214,00
	nero	FN2640272D_20	1.303,00
	grafite	FN2640272D_22	
	oro	FN2640272D_71	
	rame	FN2640272D_80	
Spokes 2 MIDI MyLight	bianco	FN2640272ML_10	1.273,00
	nero	FN2640272ML_20	1.369,00
	grafite	FN2640272ML_22	
	oro	FN2640272ML_71	
	rame	FN2640272ML_80	
Spokes 2	bianco	FN2640072R1_10	1.141,00
	nero	FN2640072R1_20	1.230,00
	grafite	FN2640072R1_22	
	oro	FN2640072R1_71	
	rame	FN2640072R1_80	
Spokes 2 dimmable	bianco	FN2640072DR1_10	1.220,00
	nero	FN2640072DR1_20	1.309,00
	grafite	FN2640072DR1_22	
	oro	FN2640072DR1_71	
	rame	FN2640072DR1_80	
Spokes 2 MyLight	bianco	FN2640072ML_10	1.282,00
	nero	FN2640072ML_20	1.374,00
	grafite	FN2640072ML_22	
	oro	FN2640072ML_71	
	rame	FN2640072ML_80	
Spokes 2 large	bianco	FN2640172R1_10	1.795,00
	nero	FN2640172R1_20	1.915,00
	grafite	FN2640172R1_22	
	oro	FN2640172R1_71	
	rame	FN2640172R1_80	
Spokes 2 large MyLight	bianco	FN2640172ML_10	1.885,00
	nero	FN2640172ML_20	2.011,00
	grafite	FN2640172ML_22	
	oro	FN2640172ML_71	
	rame	FN2640172ML_80	

Varnished steel and aluminium

LED included
30W 2700 K
3316 lm CRI>90

Dimmable version
Possible configurations:
On-Off/Push/DALI

MyLight version
Dimmable via Bluetooth
with Casambi App

CE IP 20

This product contains an energy efficiency class E + E light source

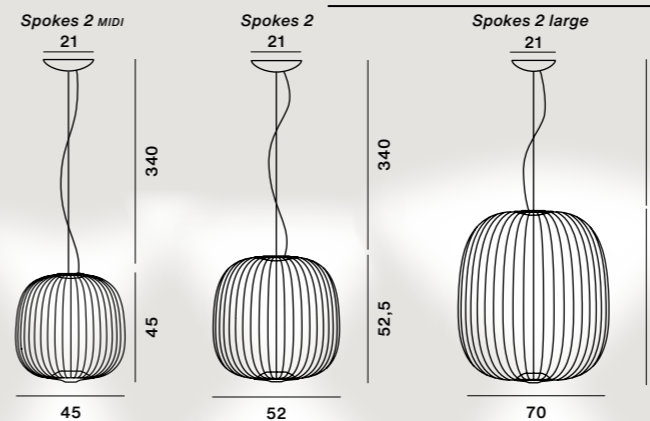

Colours: bianco, nero, grafite, oro, rame



Weight:
Spokes 2 MIDI
net kg 4,00

Spokes 2
net kg 4,40

Spokes 2 large
net kg 6,00



Garcia Cumini, 2015 - 2019

	colours	code	€
Spokes 1 h. 10 m *	bianco	FN2640071R11010	1.246,00
	nero	FN2640071R11020	1.336,00
	grafite	FN2640071R11022	
	oro	FN2640071R11071	
	rame	FN2640071R11080	
Spokes 1 dimmable h. 10 m *	bianco	FN2640071DR1110	1.324,00
	nero	FN2640071DR1120	1.415,00
	grafite	FN2640071DR1122	
	oro	FN2640071DR1171	
	rame	FN2640071DR1180	
Spokes 1 MyLight h. 10 m *	bianco	FN2640071ML1010	1.391,00
	nero	FN2640071ML1020	1.486,00
	grafite	FN2640071ML1022	
	oro	FN2640071ML1071	
	rame	FN2640071ML1080	
Spokes 2 MIDI h. 10 m *	bianco	FN2640272-10_10	1.220,00
	nero	FN2640272-10_20	1.309,00
	grafite	FN2640272-10_22	
	oro	FN2640272-10_71	
	rame	FN2640272-10_80	
Spokes 2 MIDI dimmable h. 10 m *	bianco	FN2640272D-1010	1.298,00
	nero	FN2640272D-1020	1.388,00
	grafite	FN2640272D-1022	
	oro	FN2640272D-1071	
	rame	FN2640272D-1080	
Spokes 2 MIDI MyLight h. 10 m *	bianco	FN2640272ML1010	1.364,00
	nero	FN2640272ML1020	1.457,00
	grafite	FN2640272ML1022	
	oro	FN2640272ML1071	
	rame	FN2640272ML1080	
Spokes 2 h. 10 m *	bianco	FN2640072R11010	1.227,00
	nero	FN2640072R11020	1.316,00
	grafite	FN2640072R11022	
	oro	FN2640072R11071	
	rame	FN2640072R11080	
Spokes 2 dimmable h. 10 m *	bianco	FN2640072DR1110	1.305,00
	nero	FN2640072DR1120	1.395,00
	grafite	FN2640072DR1122	
	oro	FN2640072DR1171	
	rame	FN2640072DR1180	
Spokes 2 MyLight h. 10 m *	bianco	FN2640072ML1010	1.371,00
	nero	FN2640072ML1020	1.464,00
	grafite	FN2640072ML1022	
	oro	FN2640072ML1071	
	rame	FN2640072ML1080	
Spokes 2 large h. 10 m *	bianco	FN2640172R11010	1.860,00
	nero	FN2640172R11020	1.980,00
	grafite	FN2640172R11022	
	oro	FN2640172R11071	
	rame	FN2640172R11080	
Spokes 2 large MyLight h. 10 m *	bianco	FN2640172ML1010	1.953,00
	nero	FN2640172ML1020	2.080,00
	grafite	FN2640172ML1022	
	oro	FN2640172ML1071	
	rame	FN2640172ML1080	
Spokes 3 h. 10 m *	bianco	FN2640073-10_10	1.227,00
	nero	FN2640073-10_20	1.316,00
	grafite	FN2640073-10_22	
	oro	FN2640073-10_71	
	rame	FN2640073-10_80	
Spokes 3 dimmable h. 10 m *	bianco	FN2640073D-1010	1.305,00
	nero	FN2640073D-1020	1.395,00
	grafite	FN2640073D-1022	
	oro	FN2640073D-1071	
	rame	FN2640073D-1080	
Spokes 3 MyLight h. 10 m *	bianco	FN2640073ML1010	1.371,00
	nero	FN2640073ML1020	1.464,00
	grafite	FN2640073ML1022	
	oro	FN2640073ML1071	
	rame	FN2640073ML1080	

*
On demand:
lead times to be checked
with the sales department

Garcia Cumini, 2021



Varnished steel and aluminium

LED included
19W 2700 K
2237 lm CRI>90

Dimmable version
Possible configurations:
On-Off/Push/DALI

MyLight version
Dimmable via Bluetooth
with Casambi App

CE IP 20

	colours	code	€
Spokes 2 piccola	bianco	FN2640372_10	1.013,00
	nero	FN2640372_20	1.102,00
	grafite	FN2640372_22	
	oro	FN2640372_71	
	rame	FN2640372_80	
Spokes 2 piccola dimmable	bianco	FN2640372D_10	1.084,00
	nero	FN2640372D_20	1.173,00
	grafite	FN2640372D_22	
	oro	FN2640372D_71	
	rame	FN2640372D_80	
Spokes 2 piccola MyLight	bianco	FN2640372ML_10	1.138,00
	nero	FN2640372ML_20	1.232,00
	grafite	FN2640372ML_22	
	oro	FN2640372ML_71	
	rame	FN2640372ML_80	
Spokes 2 piccola h. 10 m *	bianco	FN2640372-1010	1.098,00
	nero	FN2640372-1020	1.188,00
	grafite	FN2640372-1022	
	oro	FN2640372-1071	
	rame	FN2640372-1080	
Spokes 2 piccola dimmable h. 10 m *	bianco	FN2640372D-1010	1.169,00
	nero	FN2640372D-1020	1.258,00
	grafite	FN2640372D-1022	
	oro	FN2640372D-1071	
	rame	FN2640372D-1080	
Spokes 2 piccola MyLight h. 10 m *	bianco	FN2640372ML1010	1.228,00
	nero	FN2640372ML1020	1.321,00
	grafite	FN2640372ML1022	
	oro	FN2640372ML1071	
	rame	FN2640372ML1080	

Colours: bianco, nero,
grafite, oro, rame



Weight:
net kg 3,60

This product contains an energy
efficiency class D + E light source

*
On demand:
lead times to be
checked with
the sales
department

LED and dimming
→ specifications p. 195

Decentralization
→ specifications p. 135

MyLight collection
→ specifications p. 194

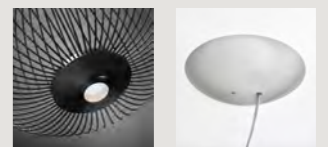

Tord Boontje, 2019



	colours	code	€
<i>Sun - Light of Love</i>	bianco	FN297007_10	1.979,00
<i>on/off</i>	oro	FN297007_71	
<i>Sun - Light of Love</i>	bianco	FN297007ML_10	2.172,00
<i>MyLight</i>	oro	FN297007ML_71	
<i>Sun - Light of Love</i>	bianco	FN297007-10_10	2.055,00
<i>h. 10 m * on/off</i>	oro	FN297007-10_71	
<i>Sun - Light of Love</i>	bianco	FN297007ML-1010	2.248,00
<i>MyLight h. 10 m *</i>	oro	FN297007ML-1071	

Liquid coated aluminium and steel

Colours: bianco, oro

Weight: net kg 13,00

This product contains an energy efficiency class E + F light source

LED included
32W 2700 K
3170 lm CRI>90

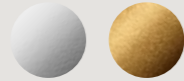

Decentralization
→ specifications p. 135

MyLight version
Dimmable via Bluetooth with Casambi App

MyLight collection
→ specifications p. 194

CE IP 20

*
On demand:
lead times to be checked with the sales department

Assembly tutorial:



tutorial.foscarini.com/SunLightOfLove

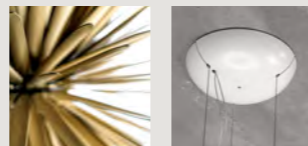
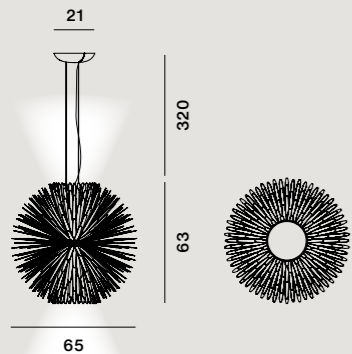

Ferruccio Laviani, 2000



	colours	code	€
<i>Supernova</i>	alluminio	FN102007_20	1.529,00
	fucsia	FN102007_66	

Lacquered or natural aluminium

Colours: alluminio, fucsia

Weight: *Supernova* net kg 8,00

Light bulbs not included
→ specifications p. 196

Max1x150W E27



White globe bulb recommended Ø 12 cm

Decentralization
→ specifications p. 135

CE IP 20

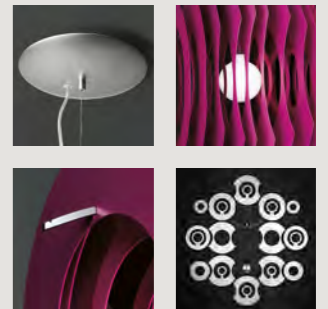
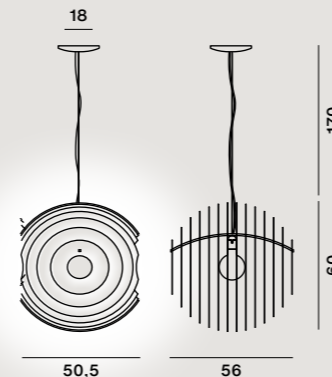



Ludovica + Roberto Palomba, 2015



	colours	code	€
Tartan	bianco	FN273007E_10	641,00
	** grigio	FN273007E_24	
Tartan LED	bianco	FN273007L_10	708,00
	** grigio	FN273007L_24	
Tartan LED dimmable	bianco	FN273007LD_10	782,00
	** grigio	FN273007LD_24	
Tartan h. 10 m *	bianco	FN273007E10_10	701,00
	** grigio	FN273007E10_24	
Tartan LED h. 10 m *	bianco	FN273007L-10_10	763,00
	** grigio	FN273007L-10_24	
Tartan LED dimmable 10 m *	bianco	FN273007LD-1010	837,00
	** grigio	FN273007LD-1024	

Hand-blown cased acid-etched glass with reliefs

Tartan
LED retrofit included
21W E27 2700 K
2451 lm CRI > 80
Dimmable with TRIAC technology

Tartan LED
included 24W COB
2700 K 2581 lm CRI>90
Dimmable version
Possible configurations:
On-Off/Push/DALI

⊕ CE IP 20

Colours:
bianco, grigio



Weight
Tartan
net kg 4,60

Tartan LED
net kg 5,20

*
On demand:
lead times to be checked with the sales department

**
Limited stock available

Tartan LED
This product contains an energy efficiency class E light source

Multiple canopy
→ specifications p. 129

Decentralization
→ specifications p. 135

LED and dimming
→ specifications p. 195

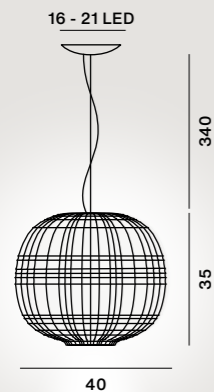

Collection →



p. 149

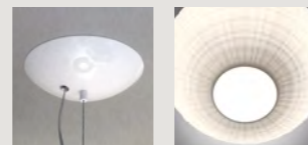

Marc Sadler, 2000



	colours	code	€
Tite 1	nero	FN111017_20	655,00
Tite 2	nero	FN111027_20	511,00
Tite 1 h. 10 m *	nero	FN111017-10_20	728,00
Tite 2 h. 10 m *	nero	FN111027-10_20	583,00

Fiberglass fabric with carbonium thread and nickel-plated steel

Max 1x116W E27

⊕ CE IP 20

Colours:
nero



Compasso D'Oro 2001

Weight:
Tite 1
net kg 1,40

Tite 2
net kg 1,00

*
On demand:
lead times to be checked with the sales department

Light bulbs not included
→ specifications p. 196

Multiple canopy
→ specifications p. 129

Decentralization
→ specifications p. 135



Collection →

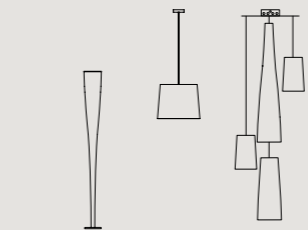

p. 057

p. 096

p. 129

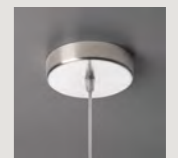

Tonda



Sospensione / Suspension

Ferruccio Laviani, 2022



	colours	code	€
Tonda	bianco/bianco	FN3180S000W10E30	594,00
	arancio/bianco	FN3180S000N10E30	
	titanio/bianco	FN3180S000T10E30	
Tonda piccola	bianco/bianco	FN3180S200W10E30	463,00
	arancio/bianco	FN3180S200N10E30	
	titanio/bianco	FN3180S200T10E30	
Tonda 10 m *	bianco/bianco	FN3180S000W10E10	647,00
	arancio/bianco	FN3180S000N10E10	
	titanio/bianco	FN3180S000T10E10	
Tonda piccola 10 m *	bianco/bianco	FN3180S200W10E10	515,00
	arancio/bianco	FN3180S200N10E10	
	titanio/bianco	FN3180S200T10E10	

Hand-blown cased glass and coated metal

Tonda
LED retrofit included
20W E27 2700 K
2452 lm CRI>80
Dimmable with TRIAC technology

Tonda piccola
LED retrofit included
14W E27 2700 K
1521 lm CRI>90

⊕ CE IP 20

Glass colours:
bianco



Frame colours:
bianco, arancio, titanio



Weight:
Tonda
net kg 4,80

Tonda piccola
net kg 3,60

*
On demand:
lead times to be checked with the sales department

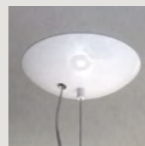
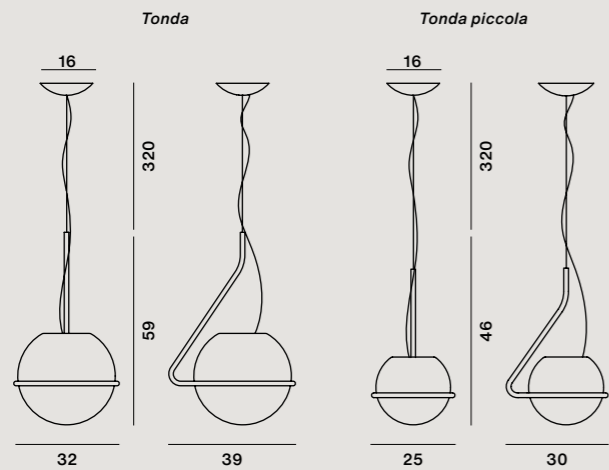

Tress

Sospensione / Suspension

Marc Sadler, 2009

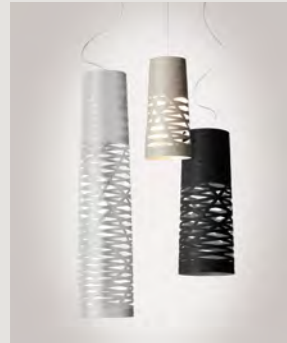

Coated fibreglass-based composite material and chromed metal

Tress media / Tress piccola
Max 1x100W E27 PAR 30

Tress mini
Max 1x75W GU10 PAR 20

⊕ CE IP 20

	colours	code	€
<i>Tress media</i>	bianco	FN182017_10	942,00
	nero	FN182017_20	
	greige	FN182017_25	
<i>Tress piccola</i>	bianco	FN182027_10	683,00
	nero	FN182027_20	
	greige	FN182027_25	
<i>Tress mini</i>	bianco	FN182037_10	583,00
	nero	FN182037_20	
	greige	FN182037_25	
<i>Tress media h. 10 m *</i>	bianco	FN182017-10_10	1.017,00
	nero	FN182017-10_20	
	greige	FN182017-10_25	
<i>Tress piccola h. 10 m *</i>	bianco	FN182027-10_10	758,00
	nero	FN182027-10_20	
	greige	FN182027-10_25	
<i>Tress mini h. 10 m *</i>	bianco	FN182037-10_10	657,00
	nero	FN182037-10_20	
	greige	FN182037-10_25	

Colours:
bianco, nero, greige

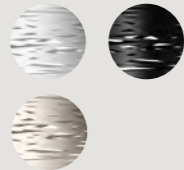

Weight:
Tress media
net kg 2,40

Tress piccola
net kg 1,60

Tress mini
net kg 1,10

Light bulbs not included
→ specifications p. 196

Decentralization
→ specifications p. 135

LED and dimming
→ specifications p. 195

*

On demand:
lead times to be checked
with the sales department

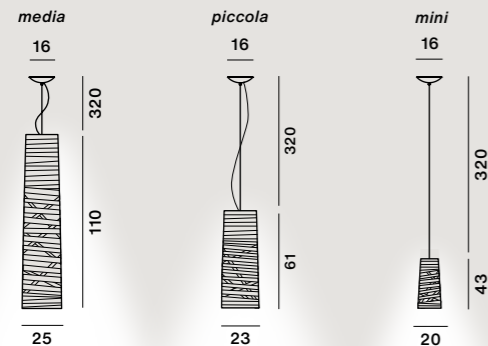

mini



media/piccola



Tress grande

Sospensione / Suspension

Marc Sadler, 2009



Coated fibreglass-based composite material, blown glass, chromed metal and aluminium

Tress grande ^{LED}
LED included
28W 2700 K
3840 lm CRI>90
Dimmable version
Possible configurations:
On-Off/Push/DALI

Version MyLight
Dimmable via Bluetooth
with Casambi App [Ⓜ]

Tress grande R7s
Max 1x160W R7s

⊕ CE IP 20

	colours	code	€
<i>Tress grande LED on/off</i>	bianco	FN182007L_10	1.110,00
	nero	FN182007L_20	
	greige	FN182007L_25	
<i>Tress grande LED dimmable</i>	bianco	FN182007LD_10	1.610,00
	nero	FN182007LD_20	
	greige	FN182007LD_25	
<i>Tress grande LED MyLight</i>	bianco	FN182007L1M_10	1.699,00
	nero	FN182007L1M_20	
	greige	FN182007L1M_25	
<i>Tress grande R7s</i>	bianco	FN182007_10	1.836,00
	nero	FN182007_20	
	greige	FN182007_25	
<i>Tress grande LED on/off h. 10 m *</i>	bianco	FN182007L1-1010	1.269,00
	nero	FN182007L1-1020	
	greige	FN182007L1-1025	
<i>Tress grande LED dimmable h. 10 m *</i>	bianco	FN182007L1D-1010	1.761,00
	nero	FN182007L1D-1020	
	greige	FN182007L1D-1025	
<i>Tress grande R7s h. 10 m *</i>	bianco	FN182007-10_10	1.849,00
	nero	FN182007-10_20	
	greige	FN182007-10_25	

Colours:
bianco, nero, greige

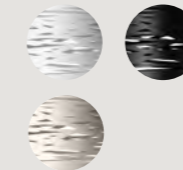

Weight:
LED
net kg 4,90

Halogen
net kg 3,10

Tress grande LED
This product contains an energy efficiency class D light source

Tress grande R7s
Light bulbs not included
→ specifications p. 196

Decentralization
→ specifications p. 135

LED and dimming
→ specifications p. 195

MyLight collection
→ specifications p. 194

*

On demand:
lead times to be checked
with the sales department

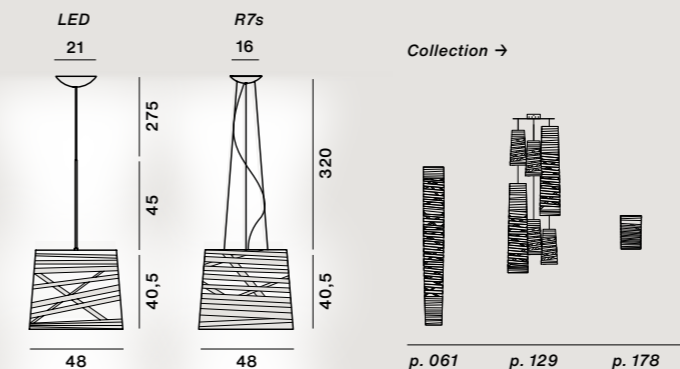

LED



R7s

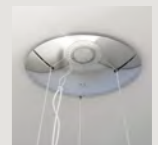

Luca Nichetto, 2010



	colours	code	€
Troag media LED	naturale	FN205007L_50	1.083,00
Troag media LED MyLight	naturale	FN205007ML_50	1.185,00
Troag media h.10 m*	naturale	FN205007L-1050	1.170,00
Troag media MyLight h.10 m*	naturale	FN205007ML-1050	1.272,00

Curved ash plywood and PMMA

Colours:
naturale

Weight:
net kg 2,50

This product contains an energy efficiency class D light source

Troag media LED
43W 3000 K
6080 lm CRI>90
Possible configurations:
On-Off/Push/DALI



LED and dimming
→ specifications p. 195

MyLight collection
→ specifications p. 194

MyLight version
Dimmable via Bluetooth
with Casambi App

⊕ Ⓢ IP 20

*
On demand:
lead times to be checked with the sales department

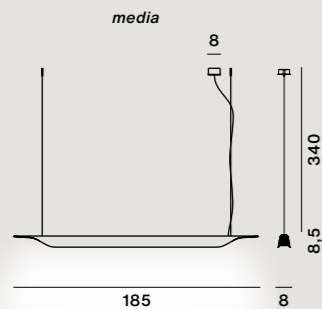

Marc Sadler, 2016



	colours	code	€
Twice as Twiggy	bianco	FN275017_10	3.358,00
	nero	FN275017_20	
	greige	FN275017_25	
	cremisi	FN275017_67	
Twice as Twiggy h. 10 m *	bianco	FN275017-10_10	3.377,00
	nero	FN275017-10_20	
	greige	FN275017-10_25	
	cremisi	FN275017-10_67	

Coated fibreglass-based composite material, coated metal, PMMA and aluminium

Colours:
bianco, nero,
cremisi, greige

Weight:
net kg 8,40

This product contains an energy efficiency class D light source

LED included
81W 3000 K
8517 lm CRI>90
Dimmable
Possible configurations:
On-Off/Push/DALI

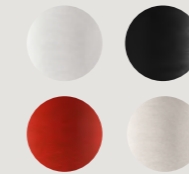

*
On demand:
lead times to be checked
with the sales
department

⊕ Ⓢ IP 20

LED and dimming
→ specifications p. 195

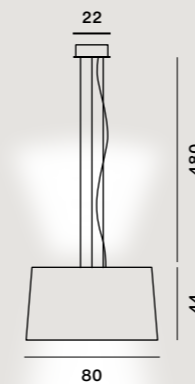

Collection →

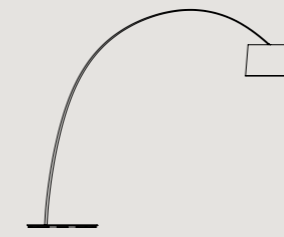

p. 063



Twiggy

Sospensione / Suspension

Marc Sadler, 2007



	colours	code	€
Twiggy grande	bianco	FN159007_10	970,00
	nero	FN159007_20	
Twiggy grande h. 10 m *	bianco	FN159007-10_10	996,00
	nero	FN159007-10_20	

Coated fibreglass-based composite material, PMMA, and polycarbonate

Max 3x77W E27

⚡ CE IP 20

Colours:
bianco, nero



Weight:
net kg 1,80

*
On demand:
lead times to be checked with the sales department

Light bulbs not included
→ specifications p. 196

Decentralization
→ specifications p. 135

Collection →

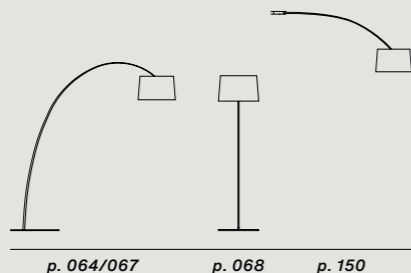
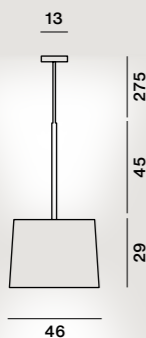

Twiggy Wood

LED

Sospensione / Suspension

Marc Sadler, 2021



	colours	code	€
Twiggy Wood on/off	greige	FN159007W2_50	1.189,00
Twiggy Wood dimmable	greige	FN159007WD2_50	1.441,00
Twiggy Wood MyLight	greige	FN159007WM2_50	1.213,00

Limed oak wood, fibreglass coated with composite material, PMMA, polycarbonate and aluminium

LED included
28W 2700K
3840 lm CRI>90

Dimmable version
Possible configurations:
On-Off/Push/DALI

MyLight version
Dimmable via Bluetooth
with Casambi App

⚡ CE IP 20

Diffuser colours:
oak



Frame colours:
greige



Weight:
net kg 2,80

This product contains an energy efficiency class E light source

LED and dimming
→ specifications p. 195

Decentralization
→ specifications p. 135

MyLight collection
→ specifications p. 194

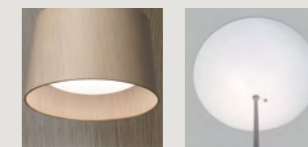

Uto

Sospensione / Suspension

Lagranja Design, 2005



	colours	code	€
Uto	bianco	FN142000_10	489,00
	giallo	FN142000_50	
	arancio	FN142000_53	

Thermoplastic elastomer and polycarbonate

Colours:
bianco, giallo, arancio

Weight:
net kg 2,00

Light bulbs not included
→ specifications p. 196

Max 1x12W E27
Switch inside the flexible tube



CE IP 44



Collection →



p. 192

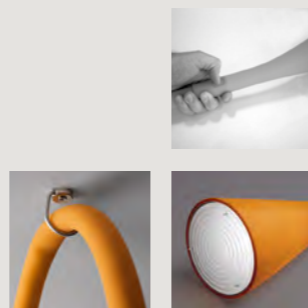

Sun-Light of Love Tord Boontje

→ Technical info p. 112



Rosoni multipli / *Multiple canopies*

Gregg grande
media + MIDI
Ludovica + Roberto
Palomba

→ Technical info p. 094



Index

Accessori / Accessories

128 Rosoni multipli
Multiple canopies

134 Kit decentramento
Decentralization kit

Rosoni multipli / Multiple canopies

Chouchin Reverse



Aplomb



A technical solution that couples function with design harmony: The multiple canopy makes it possible to create compositions up to 6/9 suspension lamps to create cascades of light of high emotional impact, particularly suitable to enrich a staircase. The standard multiple flange is designed to suit many suspensions from Foscarini collections.

Varnished steel. Colour: white. Max: 30 kg.

⊕ CE IP 20

Buds

Rosoni multipli / Multiple canopies

Accessori / Accessories

round

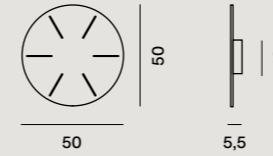

linear 90 cm

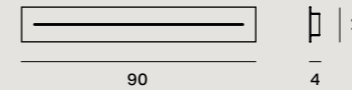

linear 135 cm

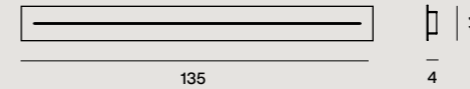

Round canopy	code	€
	FNROSONE01_10	576,00

Weight:
net kg 9,00

Linear canopy	code	€
L 90	FNROSONE02_10	484,00

Weight:
net kg 7,00

Linear canopy	code	€
L 135	FNROSONE03_10	644,00

Weight:
net kg 10,00

Max refers to installation in staggered composition.

* Excluded integrated LED version.

Model	Round	Linear 90	Linear 135
<i>Aplomb - Aplomb mini</i>	max 9	max 6	max 9
<i>Birdie grande</i>	max 6	max 6	max 9
<i>Birdie piccola</i>	max 9	max 6	max 9
<i>Buds 1 *</i>	max 6	max 6	max 9
<i>Buds 2 *</i>	max 6	max 4	max 6
<i>Buds 3 *</i>	max 6	max 5	max 8
<i>Chouchin / C. Reverse 1 *</i>	max 6	max 4	max 6
<i>Chouchin / C. Reverse 2 *</i>	max 6	max 6	max 9
<i>Chouchin / C. Reverse 3 *</i>	max 6	max 5	max 8
<i>Gem *</i>	max 5	max 4	max 5
<i>Gregg grande *</i>	max 5	max 4	max 5
<i>Gregg media *</i>	max 6	max 5	max 5
<i>Gregg midi</i>	max 6	max 6	max 6
<i>Gregg piccola</i>	max 9	max 6	max 9
<i>Havana</i>	max 6	max 6	max 9
<i>Plass media</i>	max 6	max 5	max 8
<i>Rituals 1</i>	max 6	max 6	max 9
<i>Rituals 2</i>	max 6	max 5	max 7
<i>Rituals 3</i>	max 9	max 6	max 9
<i>Rituals XL *</i>	max 5	max 4	max 5
<i>Satellight</i>	max 6	max 5	max 6
<i>Tartan *</i>	max 5	max 4	max 5
<i>Tite 1 / Tite 2</i>	max 9	max 6	max 9
<i>Tonda</i>	max 5	max 4	max 5
<i>Tonda piccola</i>	max 6	max 5	max 7
<i>Tress media / Tress piccola</i>	max 6	max 6	max 9
<i>Tress mini</i>	max 9	max 6	max 9

Rosoni multipli / *Multiple canopies*

Rituals 1-2-3
Ludovica + Roberto
Palomba

→ Technical info p. 104



Rosoni multipli / *Multiple canopies*

Accessori / Accessories

Birdie



Aplomb + Aplomb mini



Tartan

Rituals XL

Rosoni multipli / *Multiple canopies*

Gregg piccola



Gem

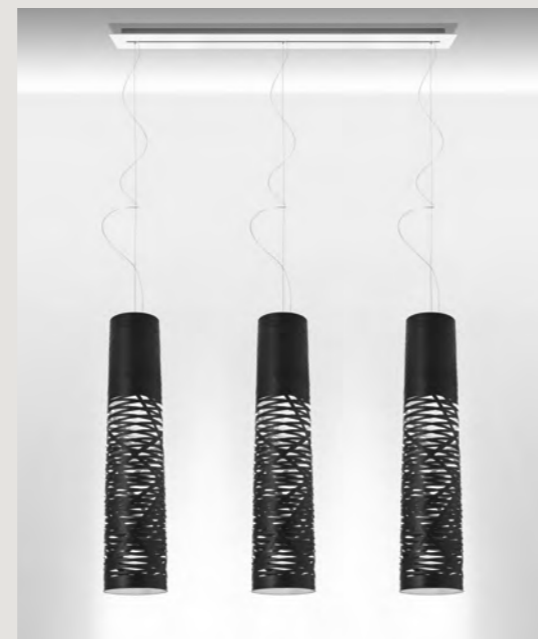
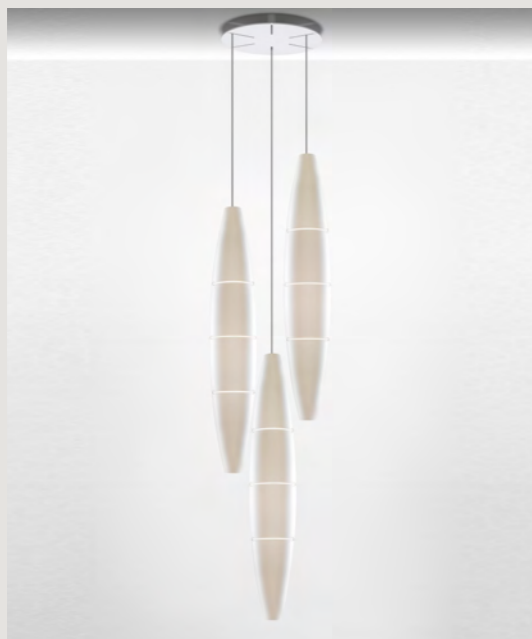

Havana

Tress media

Rosoni multipli / *Multiple canopies*



Plass media

Kit decentramento / Decentralization kit

Kit B



Kit C



With the decentralization kits, it is possible to position suspension lamps at will, regardless of the location of the power source. With an extremely discreet design, to minimize the visual impact, it is proposed for both self-supporting single cable models and for those equipped with one or more steel cables.



Kit M

Kit decentramento / Decentralization kit

Accessori / Accessories

Kit B



Kit B	code	€
	FNKIT_DEC_B	38,00

Decentralization kit, includes 3 supports for steel cables. Brushed metal.

For the models: Allegretto, Allegro, Big Bang, Buds, Caboche Plus, Chouchin, Chouchin Reverse, Gem, Gregg grande/media, Le Soleil, Nuée, Plass grande, Plass media, Rituals, Rituals XL, Satellight, Spokes, Sun-Light of Love, Supernova, Tartan, Tonda, Twice as Twiggy, Tress grande/media/piccola.

Weight:
net kg 0,01

Kit C



Kit C	code	€
	FNKIT_DEC_C	46,00

Decentralization for power cable. Chromed metal.

For the models: Aplomb, Aplomb Large, Aplomb mini, Birdie, Bump, Giga-Lite, Gregg piccola/MDI, Havana, Tite, Tress grande LED, Tress mini, Twiggy, Twiggy wood.

Weight:
net kg 0,01



Kit M

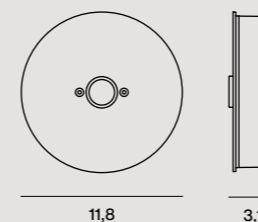

Kit M	code	€
	FNKIT_DEC_M	119,00

Canopy electrical decentralization up to 4 lamps. The kit M contains only the canopy, to compositions as picture order the necessary quantity of Kit B or Kit C. Varnished steel.

For the models: Aplomb, Aplomb mini, Arumi, Birdie, Buds*, Bump, Chouchin*, Chouchin Reverse*, Chouchin mini, Gem, Gregg*, Havana, Plass media, Rituals, Rituals XL*, Satellight, Tartan*, Tite, Tress*, Twiggy.
* LED version excluded.

Weight:
net kg 0,01



Chouchin

Ionna Vautrin

→ Technical info p. 142



Index

Soffitto / Ceiling

138	Bahia / Bahia mini	145	Gem
139	Big Bang	146	Gregg
140	Birdie	147	Lumiere XX
141	Caboche Plus	148	Rituals
142	Chouchin	149	Tartan
143	Circus	150	Twiggy
144	Folio		

Lucidi e Pevere, 2010-2015



	colours	code	€
Bahia LED	bianco	FN196005L_10	829,00
Bahia LED dimmable	bianco	FN196005LD_10	897,00
Bahia mini LED	bianco	FN1960052L_10	533,00
Bahia mini LED dimmable	bianco	FN1960052LD_10	601,00
Bahia mini MyLight	bianco	FN1960052ML_10	763,00

Injection moulded polycarbonate

Colours: bianco

Weight:
Bahia
net kg 4,40

This product contains an energy efficiency class E light source

Bahia mini
net kg 2,70LED and dimming
→ specifications p. 195MyLight collection
→ specifications p. 194

Bahia LED included
43W 2850 K
5240 lm CRI>90
Dimmable version
Possible configurations:
On-Off/Push/DALI

Bahia mini LED included
21W 2850 K
2620 lm CRI>90
Dimmable version
Possible configurations:
On-Off/Push/DALI

MyLight version
Dimmable via Bluetooth
with Casambi App

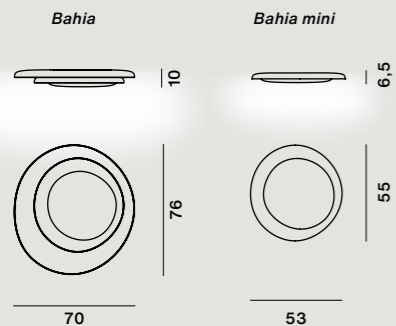

Collection →

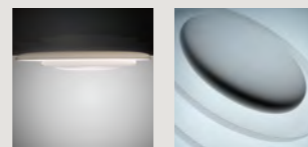
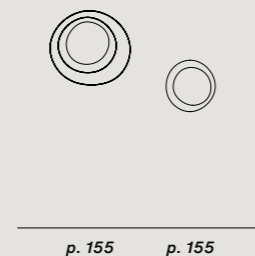

Enrico Franzolini con Vicente Garcia Jimenez, 2005



	colours	code	€
Big Bang	bianco	FN151005_10	572,00
	rosso	FN151005_63	594,00

Methacrylate and coated metal

Colours: bianco, rosso

Weight:
net kg 3,00Light bulbs not included
→ specifications p. 196

Max 1x120W R7s

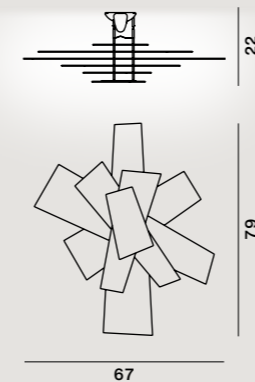

Collection →

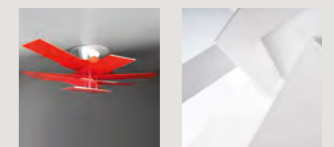
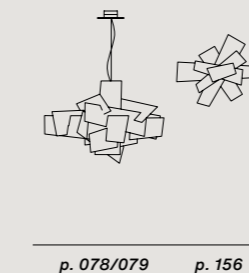

Ludovica + Roberto Palomba, 2012-2013



	colours	code	€
Birdie 3 **	bianco	FN2210083_10	951,00
	grigio	FN2210083_25	
Birdie 6 **	bianco	FN2210086_10	1.787,00
	grigio	FN2210086_25	
Birdie 9 **	bianco	FN2210089_10	2.644,00
	grigio	FN2210089_25	
Birdie 6 with cables **	bianco	FN2210076_10	2.080,00
	grigio	FN2210076_25	
Birdie 9 with cables **	bianco	FN2210079_10	2.937,00
	grigio	FN2210079_25	

Polycarbonate and coated aluminium

Colours: bianco, grigio

Weight: **Birdie 3** net kg 3,70

Light bulbs not included → specifications p. 196

Max 3-6-9x70W E27



Birdie 6 net kg 6,60

** Limited stock available

⊕ CE IP 20

Birdie 9 net kg 9,50

Patricia Urquiola con Eliana Gerotto, 2006-2021



	colours	code	€
Caboche Plus LED	trasparente	FN311008_16	1.296,00
	grigio	FN311008_25	
Caboche Plus LED dimmable	trasparente	FN311008D_16	1.408,00
	grigio	FN311008D_25	
Caboche Plus LED MyLight	trasparente	FN311008ML_16	1.408,00
	grigio	FN311008ML_25	

PMMA, steel, polycarbonate and aluminium

Colours: trasparente, grigio

Weight: net kg 7,90

This product contains an energy efficiency class E light source

LED inclusi
26W 2700 K
3645 lm CRI>90



LED and dimming → specifications p. 195

Dimmable version
Possible configurations: On-Off/Push/DALI

MyLight collection → specifications p. 194

MyLight version
Dimmable via Bluetooth with Casambi App

⊕ CE IP 20

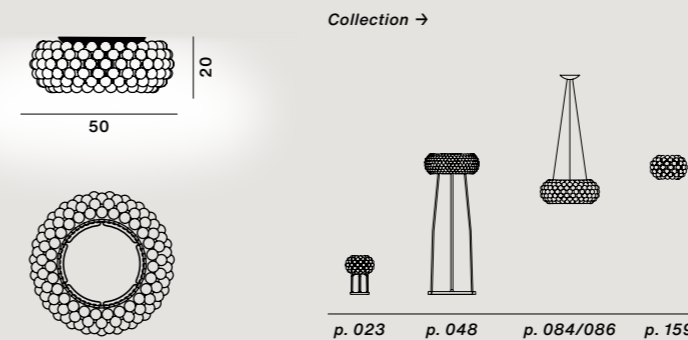
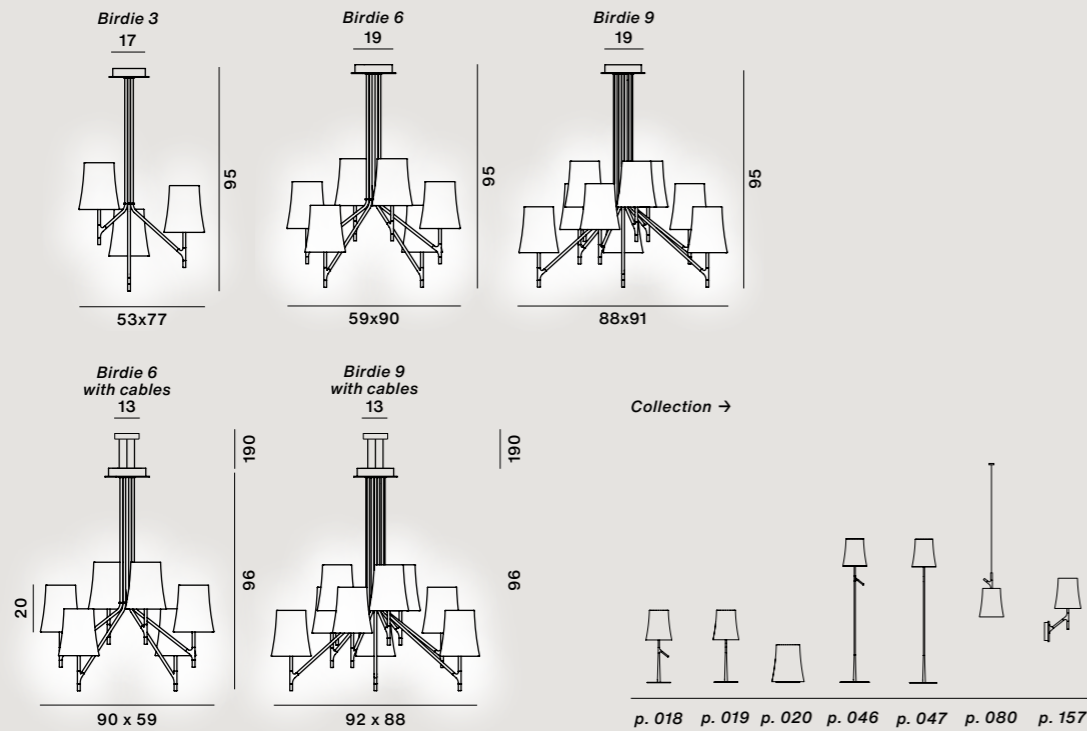

Ionna Vautrin, 2011 - 2022



	colours	code	€
<i>Chouchin bianco 2</i>	bianco	FN210082E_11	566,00
<i>Chouchin bianco 3</i>	bianco	FN210083E_11	494,00
<i>Chouchin 2 Reverse</i>	verde	FN210082E_04	643,00
<i>Chouchin 3 Reverse</i>	grigio	FN210083E_02	570,00

Liquid coated hand-blown cased glass and ABS

LED retrofit included
18W E27 2700 K
2452lm CRI>80
Dimmable with TRIAC technology

⊕ CE IP 20

Colours:
Chouchin bianco 2 - 3
bianco



Chouchin Reverse 2
bianco / verde

Chouchin Reverse 3
bianco / grigio



Weight:
Chouchin 2
net kg 2,10

Chouchin 3
net kg 1,90

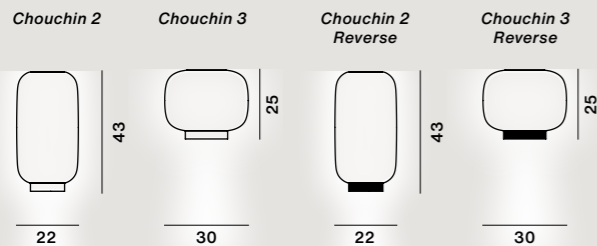

Collection →

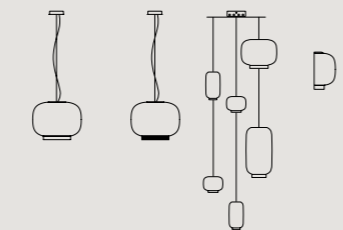

p. 088-089 p. 090 p. 129 p. 160

Defne Koz, 1994



	colours	code	€
<i>Circus grande</i>	bianco	FN0460081_11	560,00
<i>Circus piccola</i>	bianco	FN046008_11	356,00

Hand-blown cased glass, nickel-plated or coated metal

Colours:
bianco



Circus grande
Max 4x60W E27

⊕ CE IP 20

Circus piccola
Max 4x40W E14

⊕ CE IP 20

Weight:
Circus grande
net kg 4,70

Circus piccola
net kg 2,10

Light bulbs not included
→ specifications p. 196

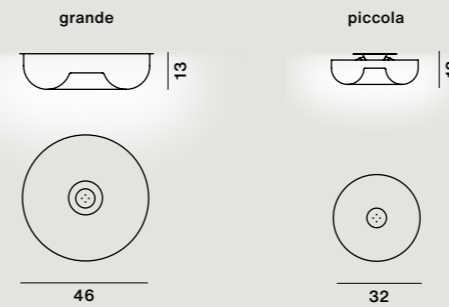

Collection →



p. 161

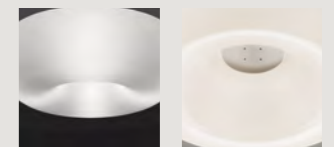

Folio

Soffitto / Ceiling

Carlo Urbinati e Alessandro Vecchiato, 1990



	colours	code	€
Folio grande	bianco	FN019008_10	480,00

Hand-blown cased satin glass and coated metal

Colours: bianco

Weight: net kg 2,20

Light bulbs not included → specifications p. 196

Max 1x120W R7s

⊕ CE IP 20



Collection →

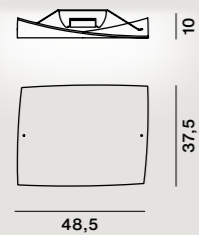

p. 165



Gem



Soffitto / Ceiling

Ludovica + Roberto Palomba, 2015-2017



	colours	code	€
Gem	bianco	FN274008_10	608,00

Hand-blown cased acidetched glass with reliefs and ABS

Colours: bianco

Weight: netto kg 6,50

LED retrofit included
18W E27 2700 K
2452lm CRI>80
Dimmable with TRIAC technology

⊕ CE IP 20



Collection →

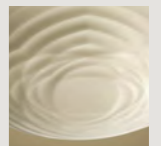
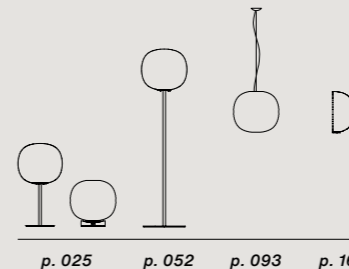
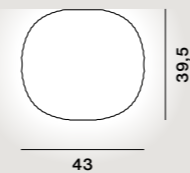

Ludovica e Roberto Palomba, 2007



	colours	code	€
Gregg grande	bianco	FN1680081_10	607,00
Gregg media	bianco	FN168005R1_10	409,00
Gregg midi	bianco	FN168035E_10	314,00
Gregg piccola	bianco	FN1680052R1B10	136,00

Hand blown acid-etched glass and ABS

Glass colours: bianco

Weight:
Gregg grande
net kg 5,10

Gregg piccola
Light bulbs not included
→ specifications p. 196

Gregg grande/media
LED retrofit included
1x18W E27 2700K
2452 lm CRI>80



Gregg media
net kg 2,00

Gregg midi
net kg 1,60

Gregg midi
LED retrofit included
1x6,5W E14 2700K
806 lm CRI>80

Gregg piccola
net kg 0,60

IP 20

Gregg piccola
Max 1x8W G9

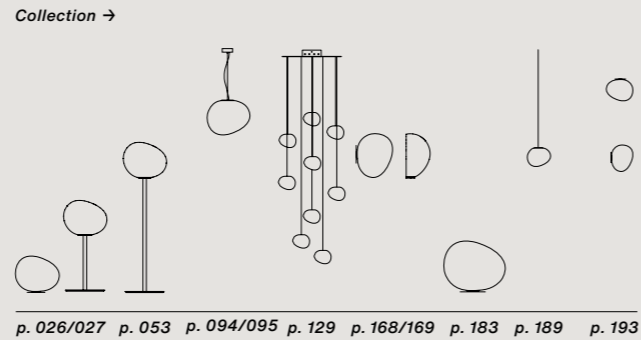
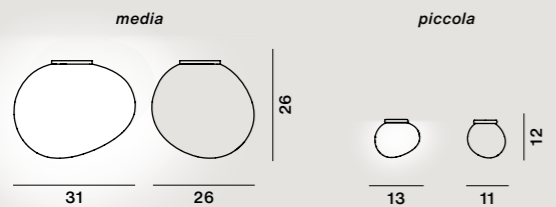
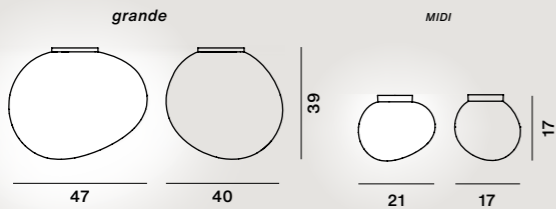

Rodolfo Dordoni, 2010



	colours	code	€
Lumiere XXL G9	bianco	FN191005E_11	537,00
	grigio	FN191005E_24	594,00
Lumiere XXS G9	bianco	FN191025E_11	445,00
	grigio	FN191025E_24	474,00

Hand-blown cased glass and coated metal

Colours: bianco, grigio freddo

Weight:
Lumiere XXL
net kg 3,40

Light bulbs not included
→ specifications p. 196

Lumiere XXL G9
max 4x8W G9



Lumiere XXS
net kg 1,80

Lumiere XXS G9
max 3x8W G9

IP 20

Lumiere XXL

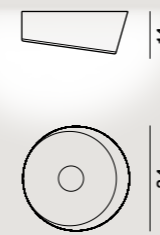

Lumiere XXS

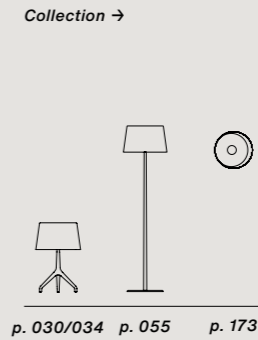

Ludovica e Roberto Palomba, 2015



	colours	code	€
Rituals 1	bianco	FN2440081R1_10	481,00
Rituals 2	bianco	FP2440052R1_10	481,00
Rituals 3	bianco	FN2440083R1_10	413,00
Rituals XL	bianco	FN2440084R1_10	725,00

Hand-blown cased engraved satin glass and ABS

Colours: bianco

Weight:
Rituals 1
net kg 2,10

Light bulbs not included
→ specifications p. 196

Rituals 1-2-3
LED retrofit included
1x11 W E27 2700 K
1521 lm CRI>80



Rituals 2
net kg 2,50

Rituals 3
net kg 1,30

Rituals XL
LED retrofit included
1x18 W E27 2700 K
2452 lm CRI>80

Rituals XL
net kg 4,70

⊕ CE IP 20

Collection →

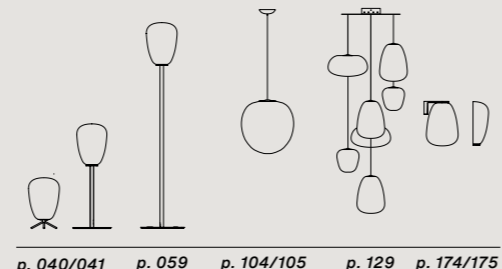
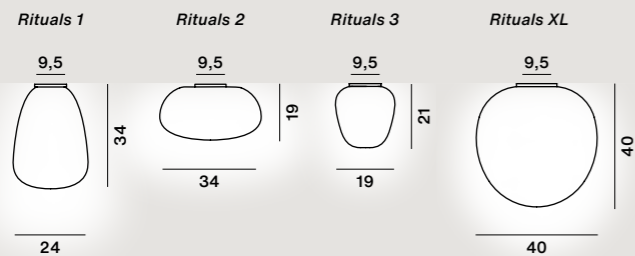

Ludovica + Roberto Palomba, 2015-2017



	colours	code	€
Tartan	bianco	FN273008_10	641,00

Hand-blown cased acidetched glass with reliefs and ABS

Colours: bianco

Weight:
netto kg 3,45

LED retrofit included
18W E27 2700 K
2452lm CRI>80
Dimmable with
TRIAC technology



⊕ CE IP 20

Collection →

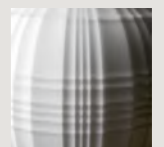

Twiggy

Soffitto / Ceiling

Marc Sadler, 2007



	colours	code	€
Twiggy	bianco	FN159008_10	1.322,00
	nero	FN159008_20	

Compound material on lacquered glass fibre base, PMMA and lacquered metal

Max 3x77W E27

Rotating 330°
Stem lenght cannot be changed

⊕ CE  IP 20

Colours:
bianco, nero



Weight:
net kg 5,60

Light bulbs not included
→ specifications p. 196

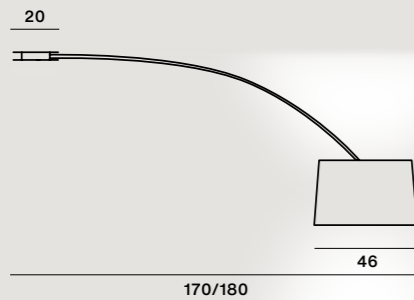

Collection →

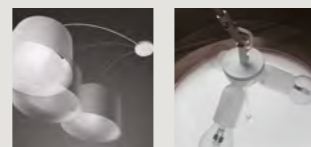
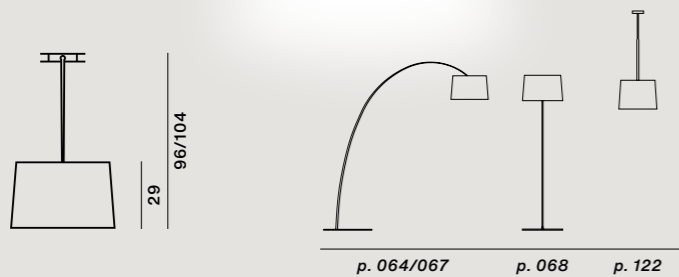

Tress

Mark Sadler

→ Technical info p. 178



Index

Parete / Wall

154	Aplomb	167	Gioia
155	Bahia / Bahia mini	168	Gregg
156	Big Bang	169	Gregg semi
157	Birdie	170	Havana
158	Bit	171	Lake
159	Caboche Plus	172	Le Soleil
160	Chouchin semi	173	Lumiere XX
161	Circus	174	Rituals
162	Double	175	Rituals semi
163	Fields	176	Satellight
164	Filo	177	Tobia
165	Folio	178	Tress
166	Gem	179	Tutù

Aplomb

Parete / Wall

Lucidi e Pevere, 2014



	colours	code	€
Aplomb R7s	bianco	FN195005E_10	471,00
	grigio	FN195005E_25	
	marrone	FN195005E_52	

Hand pouring concrete, varnished metal and aluminium

Max 1x17,5W R7s

⚡ CE IP 20

Colours: bianco, grigio cemento, marrone



Weight: net kg 2,00

Light bulbs not included → specifications p. 196

Collection →

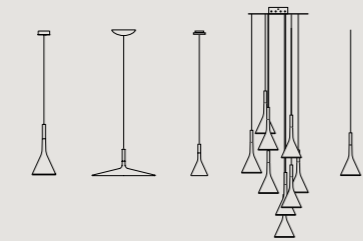
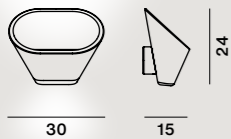

p. 074 p. 075 p. 076 p. 129 p. 188



Bahia + Bahia mini

LED

Parete / Wall

Lucidi e Pevere, 2010-2015



	colours	code	€
Bahia LED	bianco	FN196005L_10	829,00
Bahia LED dimmable	bianco	FN196005LD_10	897,00
Bahia mini LED	bianco	FN1960052L_10	533,00
Bahia mini LED dimmable	bianco	FN1960052LD_10	601,00
Bahia mini MyLight	bianco	FN1960052ML_10	763,00

Injection moulded polycarbonate

Colours: bianco



Weight: Bahia net kg 4,40

Bahia mini net kg 2,70

This product contains an energy efficiency class E light source

LED and dimming → specifications p. 195

MyLight collection → specifications p. 194

Bahia LED included
43W 2850 K
4850 lm CRI>90
Dimmable version
Possible configurations: On-Off/Push/DALI

Bahia mini LED included
21W 2850 K
2425 lm CRI>90
Dimmable version
Possible configurations: On-Off/Push/DALI

MyLight version
Dimmable via Bluetooth with Casambi App

⚡ CE IP 20

Collection →

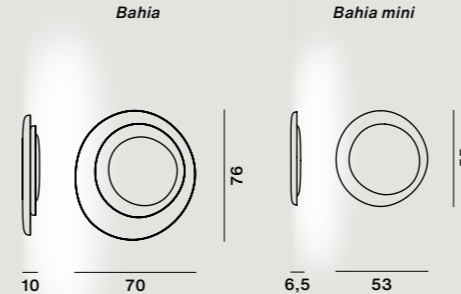

p. 138

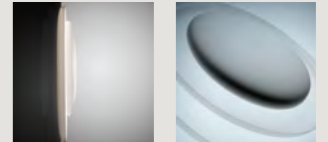

Big Bang

Parete / Wall

Enrico Franzolini con Vicente Garcia Jimenez, 2005



	colours	code	€
Big Bang	bianco	FN151005_10	572,00
	rosso	FN151005_63	594,00

Methacrylate and lacquered metal

Colours: bianco, rosso

Weight: net kg 3,00

Light bulbs not included → specifications p. 196

Max 1x120W R7s

⊕ CE IP 20

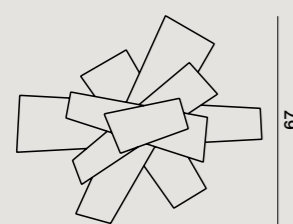

79



22

Collection →

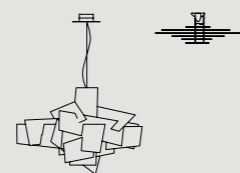

p. 078 - 079 p. 139

Birdie

Parete / Wall

Ludovica + Roberto Palomba, 2012



	colours	code	€
Birdie	bianco	FN2210052_10	300,00
	grigio	FN2210052_25	

Polycarbonate, coated steel and metal

Colours: bianco, grigio

Weight: net kg 1,60

Light bulbs not included → specifications p. 196

Max 1x70W E27

⊕ CE IP 20

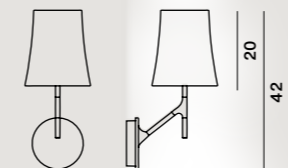

17

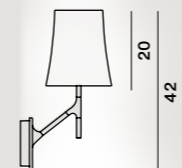

24

Collection →

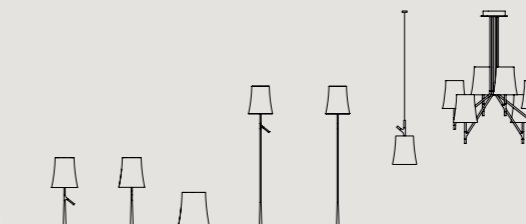

p. 018 p. 019 p. 020 p. 046 p. 047 p. 080 p. 140

Ferruccio Laviani, 1993

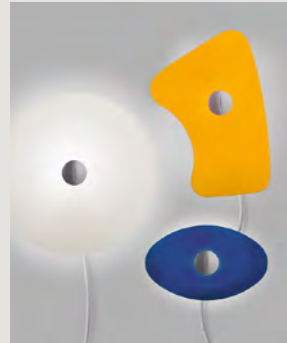

	colours	code	€
Bit 1	rosso	FN0430051	283,00
	bianco	FN0430051_10	
Bit 2	blu	FN0430052	283,00
	bianco	FN0430052_10	
Bit 3	bianco	FN0430053	283,00
Bit 4	verde	FN0430054	283,00
	bianco	FN0430054_10	
Bit 5	arancio	FN0430055	283,00
	bianco	FN0430055_10	

Silkscreen-printed glass and lacquered metal

Max 1x46W E14

Transparent cable

☐ CE IP 20

Colours: bianco, colorato (1 rosso, 2 blu, 3 bianco, 4 verde, 5 arancio)

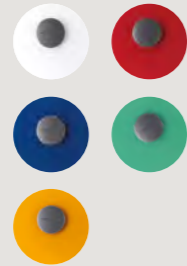

Weight:
Bit 1 net kg 1,70
Bit 2 net kg 1,20
Bit 3 net kg 1,80
Bit 4 net kg 1,25
Bit 5 net kg 1,35

Light bulbs not included → specifications p. 196

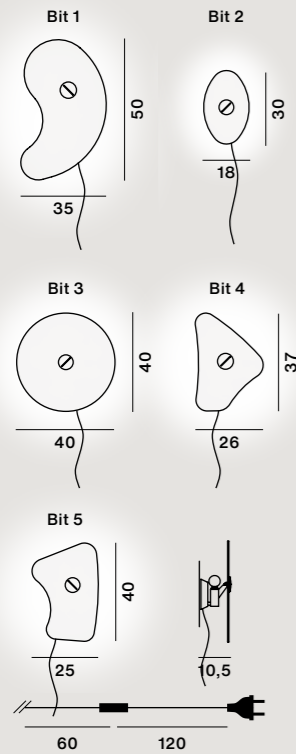

Collection →

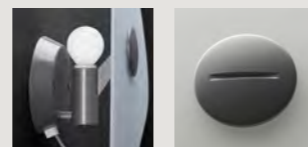
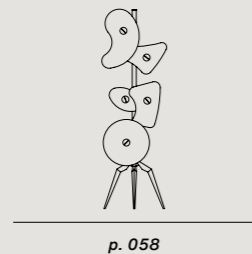

Patricia Urquiola con Eliana Gerotto, 2006



	colours	code	€
Caboche Plus media R7s	trasparente	FN311005E_16	688,00
	grigio	FN311005E_25	
Caboche Plus piccola R7s	trasparente	FN311025E_16	408,00
	grigio	FN311025E_25	

PMMA, blown glass and chromed metal and aluminium

Max 1x17,5W R7s

⊕ CE IP 20

Colours: trasparente, grigio



Weight:
Caboche Plus media net kg 4,30

Caboche Plus piccola net kg 3,00

Light bulbs not included → specifications p. 196

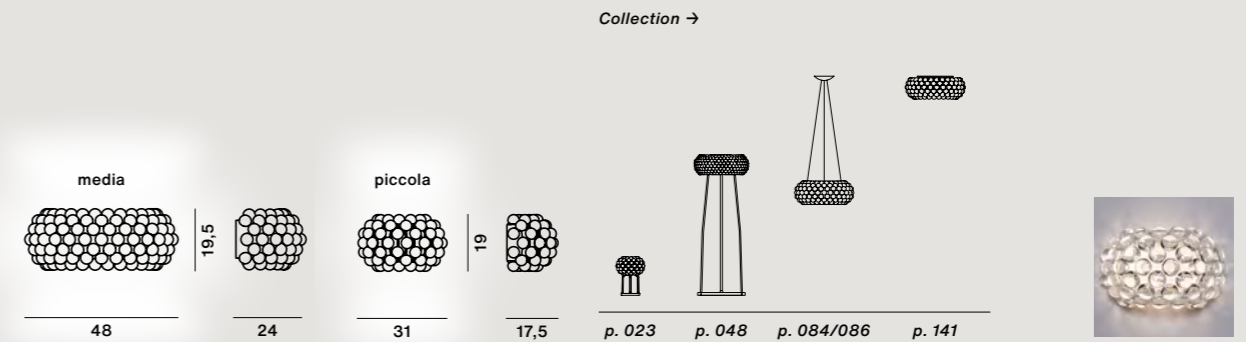

Chouchin semi

Parete / Wall

Ionna Vautrin, 2021



	colours	code	€
Chouchin semi	bianco	FN210053_11	299,00
	oro/bianco	FN210053G_11	334,00
	grafite/bianco	FN210053N_11	
Chouchin semi MyLight	** bianco	FN210053ML_11	476,00
	** oro/bianco	FN210053MG_11	513,00
	** grafite/bianco	FN210053MN_11	

Hand-blown cased glass and coated metal

Max 1x30W E27

MyLight version
Dimmable via Bluetooth with Casambi device included

IP 20

Glass colours:
bianco



Frame colours:
bianco, oro, grafite



Weight:
net kg 2,80

Light bulbs not included
→ specifications p. 196

MyLight collection
→ specifications p. 194

**
Limited stock available

Collection →

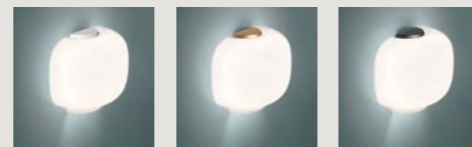
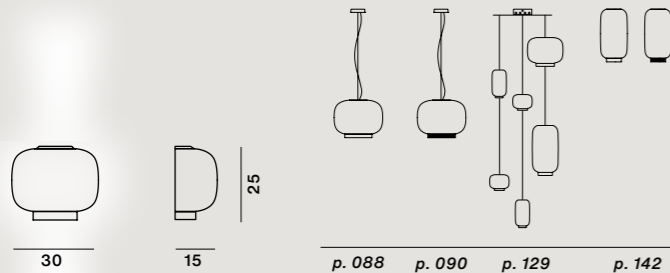

Circus

Parete / Wall

Defne Koz, 1994



	colours	code	€
Circus grande	bianco	FN0460081_11	560,00
Circus piccola	bianco	FN046008_11	356,00

Hand-blown cased glass, nickel-plated or coated metal

Circus grande
Max 4x60W E27

IP 20

Circus piccola
Max 4x40W E14

IP 20

Colours:
bianco



Weight:
Circus grande
net kg 4,70

Circus piccola
net kg 2,10

Light bulbs not included
→ specifications p. 196

Collection →

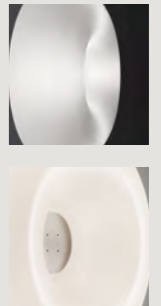
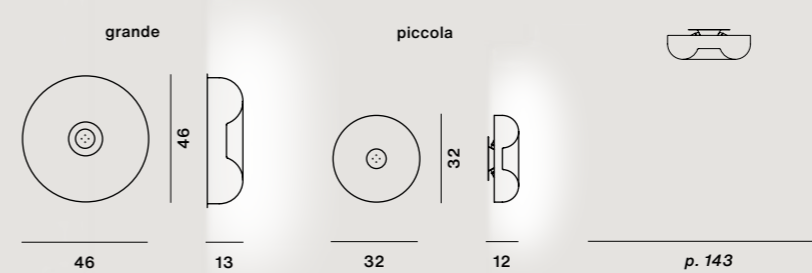

Double

Parete / Wall

Valerio Bottin, 1996



	colours	code	€
Double	bianco	FN069005_11	358,00

Hand-blown cased glass and coated metal

Colours: bianco

Weight: netto kg 2,00

Light bulbs not included → specifications p. 196

Max 2x77W E27

⊕ CE IP 20

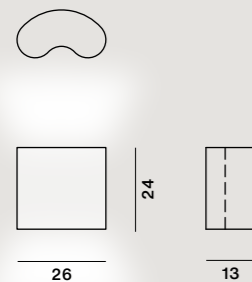

Fields

Parete / Wall

Vicente Garcia Jimenez, 2007



	colours	code	€
Fields	**bianco	FN174005_10	2.461,00
	**arancio	FN174005_63	
Fields 1	**bianco	FN1740051_10	763,00
	**arancio	FN1740051_63	
Fields 2	**bianco	FN1740052_10	895,00
	**arancio	FN1740052_63	
Fields 3	**bianco	FN1740053_10	802,00
	**arancio	FN1740053_63	

Methacrylate, coated aluminium and polycarbonate

Colours: bianco, arancio

Weight: **Fields 1** net kg 6,00

Light bulbs not included → specifications p. 196

Fields 1
Fluo 1x80W G5



Fields 2
net kg 6,50

**
Limited stock available

Fields 2
Fluo 1x54W G5

Fields 3
net kg 5,80

Fields 3
Fluo 1x39W G5

Fields
net kg 18,30

Horizontal and vertical use

Fields
Fluo 1x80W G5 + 1x54W G5 + 1x39W G5

⊕ CE IP 20

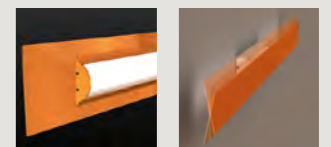
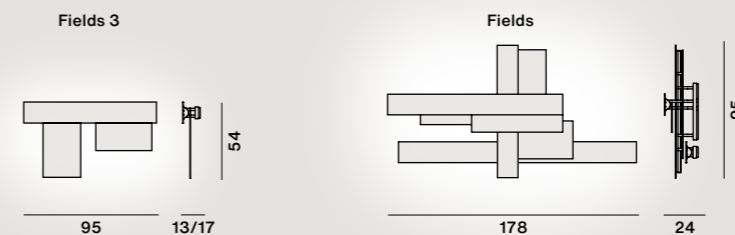
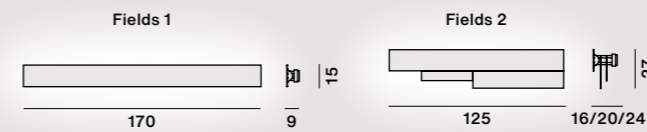



Andrea Anastasio, 2017



	colours	code	€
Filo	amethyst queen	FN289005_01	480,00
	eastern coral	FN289005_02	
	teodora	FN289005_04	
	emerald king	FN289005_08	

Porcelain, textile cable, blown glass and varnished metal

LED retrofit included
4W G9 3000 K
400 lm CRI>80

With personalized packaging

⊕ CE IP 20

Colours:
Amethyst Queen
white / black cable



Eastern Coral
fluo orange cable



Weight:
net kg 2,40

Teodora
petrol green cable



Emerald King
red / white cable



Collection →

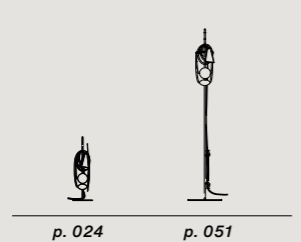
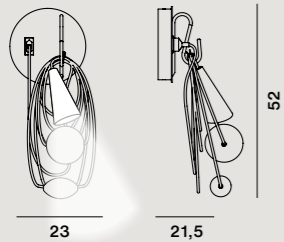

Carlo Urbinati e Alessandro Vecchiato, 1990

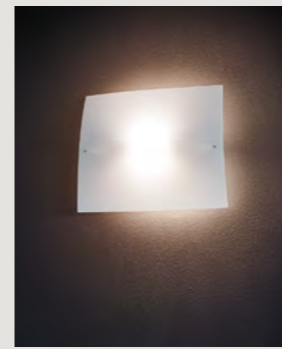

	colours	code	€
Folio grande	bianco	FN0190051_10	449,00
Folio piccola	bianco	FN019005_R1_10	337,00

Hand-blown cased satin glass and coated metal

Max 1x120W R7s

⊕ CE IP 20

Colours:
bianco



Weight:
Folio grande
net kg 2,17

Folio piccola
net kg 1,48

Light bulbs not included
→ specifications p. 196

Collection →

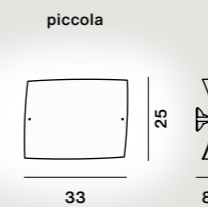
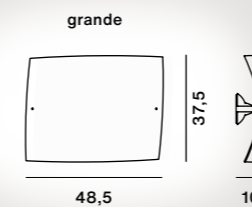

p. 144

Ludovica + Roberto Palomba, 2017 - 2019



	colours	code	€
Gem semi	bianco	FN274005_10	413,00
	oro/bianco	FN274005G_10	447,00
	grafite/bianco	FN274005N_10	447,00
Gem semi MyLight	**bianco	FN274005ML_10	624,00
	**oro/bianco	FN274005MG_10	588,00
	**grafite/bianco	FN274005MN_10	624,00

Hand-blown cased acid-etched glass with reliefs and coated metal

Max 1x30W E27

MyLight version
Dimmable via Bluetooth with Casambi device included ⓘ

⊕ CE IP 20

Glass colours:
bianco



Frame colours:
bianco, oro, grafite



Weight:
net kg 4,20

Light bulbs not included
→ specifications p. 196

MyLight collection
→ specifications p. 194

**
Limited stock available

Collection →

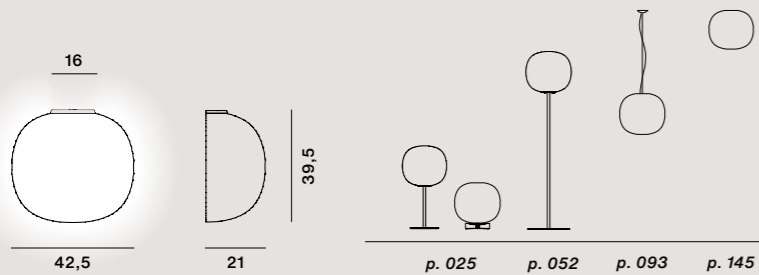

Andrea Anastasio, 2019



	colours	code	€
Gioia	azzurro	FN306005_30	847,00
	verde	FN306005_40	
	rosa	FN306005_61	
Gioia grande	azzurro	FN306015_30	1.267,00
	verde	FN306015_40	
	rosa	FN306015_61	

PMMA, marble, polycarbonate, polished brass and varnished aluminum

LED included
10W 2700 K
790 lm CRI>90
Dimmable with TRIAC technology

⊕ CE IP 20

Gray cable, switch and black plug

Plug and cable can be removed for direct power connection to the wall

With personalized packaging

Colours:
azzurro, verde, rosa



Weight:
Gioia
net kg 2,20

Gioia grande
net kg 4,10

This product contains an energy efficiency class F light source

LED and dimming
→ specifications p. 195

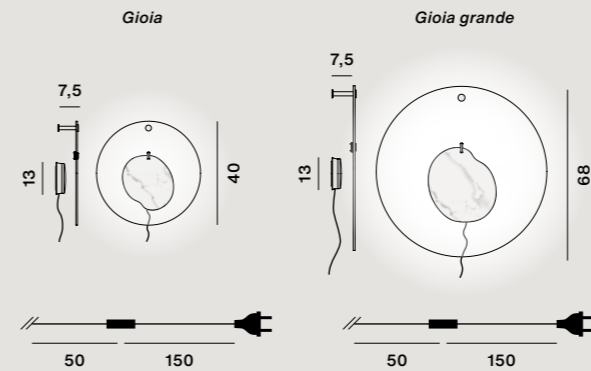

Ludovica + Roberto Palomba, 2007



	colours	code	€
Gregg media	bianco	FN168005R1_10	409,00
Gregg MIDI	bianco	FN168035E_10	314,00
Gregg piccola	bianco	FN1680052R1B10	136,00
Gregg piccola Mirror	bianco	FN168025M_10	156,00

Hand blown acid-etched glass and ABS

Glass colours:
bianco

Weight:
Gregg media
net kg 2,90

Gregg piccola
Light bulbs not included
→ specifications p. 196

Gregg media LED retrofit included
1x18 W E27 2700 K
2452 lm CRI>80
 IP 20



Gregg MIDI
net kg 1,60

Gregg piccola
net kg 0,60

Gregg MIDI LED retrofit included
1x6,5W E14 2700K
806 lm CRI>80
 IP 20

Gregg piccola
Max 1x8W G9
 IP 40

Gregg piccola Mirror
Max 1x8W G9
 IP 44

media

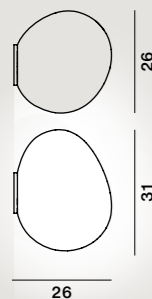

MIDI

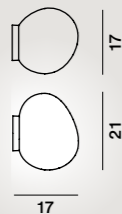

piccola

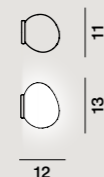

Collection →

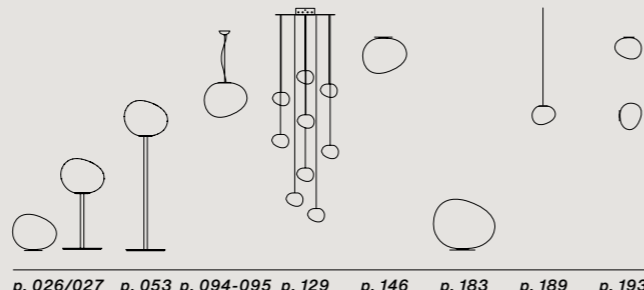

p. 026/027 p. 053 p. 094-095 p. 129 p. 146 p. 183 p. 189 p. 193

Ludovica + Roberto Palomba, 2007 - 2019



	colours	code	€
Gregg grande semi 1	bianco/bianco	FN16801511_10	437,00
	oro/bianco	FN16801511G_10	471,00
	grafite/bianco	FN16801511N_10	
Gregg grande semi 2	bianco/bianco	FN16801512_10	437,00
	oro/bianco	FN16801512G_10	471,00
	grafite/bianco	FN16801512N_10	
Gregg grande semi 1 MyLight	**bianco/bianco	FN1680151ML1_10	607,00
	**oro/bianco	FN1680151MG1_10	641,00
	**grafite/bianco	FN1680151MN1_10	
Gregg grande semi 2 MyLight	**bianco/bianco	FN1680151ML2_10	607,00
	**oro/bianco	FN1680151MG2_10	641,00
	**grafite/bianco	FN1680151MN2_10	
Gregg media semi 1	bianco/bianco	FN1680151_10	319,00
	oro/bianco	FN1680151G_10	353,00
	grafite/bianco	FN1680151N_10	
Gregg media semi 2	bianco/bianco	FN1680152_10	319,00
	oro/bianco	FN1680152G_10	353,00
	grafite/bianco	FN1680152N_10	
Gregg media semi 1 MyLight	**bianco/bianco	FN168015ML1_10	489,00
	**oro/bianco	FN168015MG1_10	524,00
	**grafite/bianco	FN168015MN1_10	
Gregg media semi 2 MyLight	**bianco/bianco	FN168015ML2_10	489,00
	**oro/bianco	FN168015MG2_10	524,00
	**grafite/bianco	FN168015MN2_10	

Hand-blown cased satin glass and coated metal

Max 1x30W E27

IP 20

MyLight version
Dimmable via Bluetooth with Casambi device included

Glass colours:
bianco



Weight:
Gregg grande semi
net kg 4,00

Light bulbs not included
→ specifications p. 196

Gregg media semi
net kg 3,00

MyLight collection
→ specifications p. 194

Frame colours:
bianco, oro, grafite



**
Limited stock available

grande semi 1

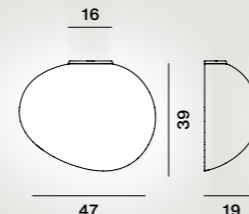

grande semi 2

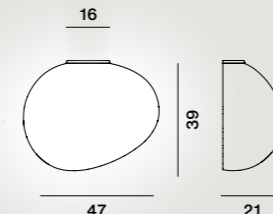

media semi 1

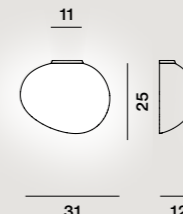

media semi 2

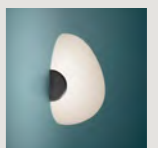
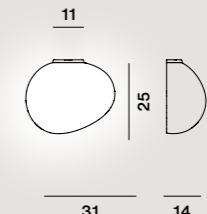

Havana

Parete / Wall

Josep Forakis, 1993

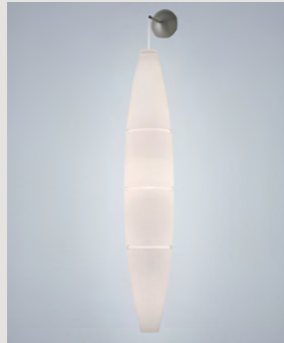

	colours	code	€
Havana	bianco	FN0400072_R1_10	292,00

Injection moulded polyethylene and coated metal

Max 1x116W E27

⚡ CE IP 20

Colours:
bianco



Weight:
net kg 1,90

Light bulbs not included
→ specifications p. 196

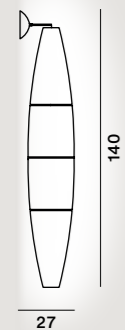

Collection →

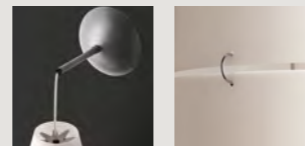
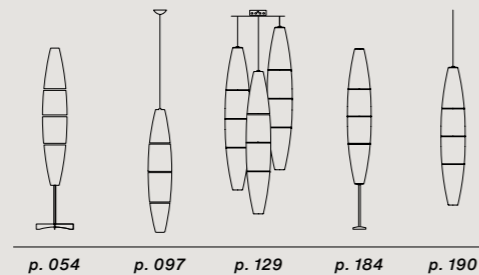

Lake

LED

Parete / Wall

Lucidi e Pevere, 2015

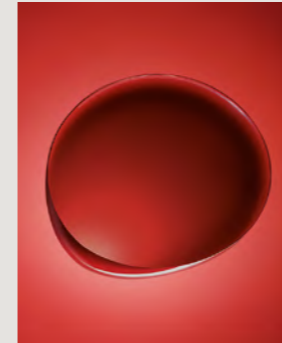

	colours	code	€
Lake	avorio	FN257005_50	628,00
	rosso	FN257005_63	

Varnished injection-molded ABS and aluminum

LED included
10W 3000 K
862 lm CRI>90
Dimmable with TRIAC technology

⚡ CE IP 20

Colours:
avorio, rosso



Weight:
net kg 5,50

This product contains an energy efficiency class F light source

LED and dimming
→ specifications p. 195

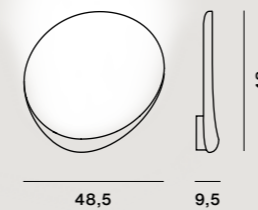

Le Soleil

Parete / Wall

Vicente Garcia Jimenez, 2013



	colours	code	€
Le Soleil R7s	bianco	FN181005E_10	295,00

Injection moulded polycarbonate and coated metal

Max 1x17,5W R7s

⚡ CE IP 20

Colours: bianco



Weight: net kg 1,60

Light bulbs not included → specifications p. 196

Collection →

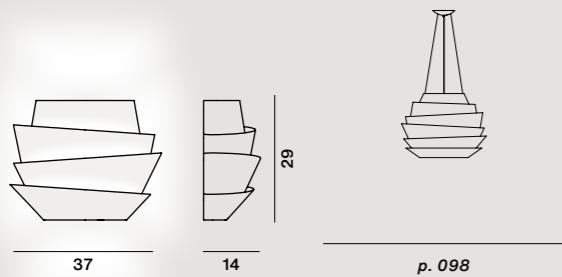

Lumiere XXL + XXS

Parete / Wall

Rodolfo Dordoni, 2010



	colours	code	€
Lumiere XXL G9	bianco	FN191005E_11	537,00
	grigio	FN191005E_24	594,00
Lumiere XXS G9	bianco	FN191025E_11	445,00
	grigio	FN191025E_24	474,00

Hand-blown cased glass and coated metal

Lumiere XXL
max 4x8W G9

Lumiere XXS
max 3x8W G9

⚡ CE IP 20

Colours: bianco, grigio freddo



Weight: **Lumiere XXL**
net kg 3,40

Lumiere XXS
net kg 1,80

Light bulbs not included → specifications p. 196

Collection →

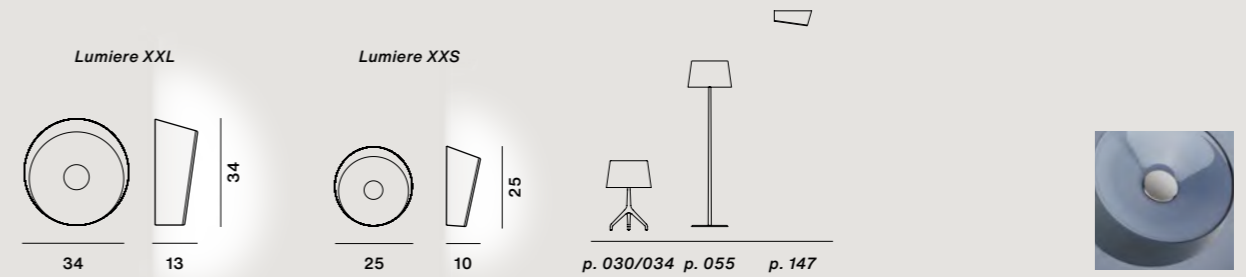

Rituals

Parete / Wall

Ludovica + Roberto Palomba, 2015 - 2019



	colours	code	€
Rituals 1	bianco	FN2440051_10	514,00
Rituals 3	bianco	FN2440053_10	450,00
Rituals 1 doppia	bianco	FN24400512_10	953,00
Rituals 3 doppia	bianco	FN24400532_10	826,00
Rituals 2	bianco	FN2440052R1_10	481,00

Hand-blown cased engraved satin glass and lacquered metal

Glass colours:
bianco



Weight:
Rituals 1
net kg 4,80

Light bulbs not included
→ specifications p. 196

Rituals 1-3
Max 1x70W E27

Rituals 3
net kg 2,40

Rituals 1-3 doppia
Max 2x70W E27

Rituals 1 doppia
net kg 8,80

Rituals 2 
LED retrofit included
1x11 W E27 2700 K
1521 lm CRI>80

Rituals 3 doppia
net kg 3,90

Rituals 2
net kg 2,50

  IP 20

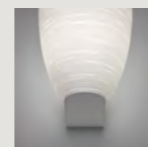
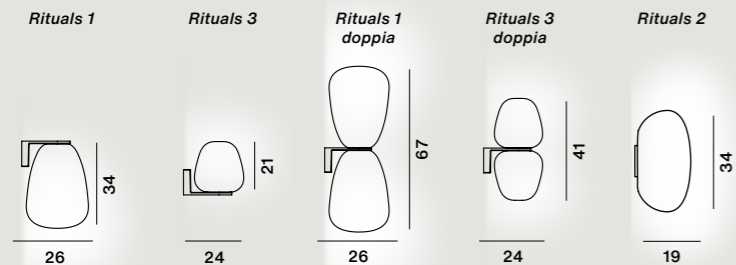

Rituals semi

Parete / Wall

Ludovica + Roberto Palomba, 2015 - 2019



	colours	code	€
Rituals 1 semi	bianco/bianco	FN244015_10	358,00
	oro/bianco	FN244015G_10	394,00
	grafite/bianco	FN244015N_10	
Rituals 1 semi MyLight	** bianco/bianco	FN244015ML_10	534,00
	** oro/bianco	FN244015MG_10	570,00
	** grafite/bianco	FN244015MN_10	
Rituals 3 semi	bianco/bianco	FN244035_10	330,00
	oro/bianco	FN244035G_10	365,00
	grafite/bianco	FN244035N_10	
Rituals 3 semi MyLight	** bianco/bianco	FN244035ML_10	506,00
	** oro/bianco	FN244035MG_10	540,00
	** grafite/bianco	FN244035MN_10	
Rituals XL semi	bianco/bianco	FN244045_10	480,00
	oro/bianco	FN244045G_10	513,00
	grafite/bianco	FN244045N_10	
Rituals XL semi MyLight	** bianco/bianco	FN244045ML_10	655,00
	** oro/bianco	FN244045MG_10	689,00
	** grafite/bianco	FN244045MN_10	

Hand-blown cased engraved satin glass and lacquered metal

Rituals semi
Max 1x30W E27

MyLight version
Dimmable via Bluetooth
with Casambi device
included 

  IP 20

Glass colours:
bianco



Weight:
Rituals 1 semi
net kg 3,20

MyLight collection
→ specifications p. 194

Rituals 3 semi
net kg 2,00

**
Limited stock available

Frame colours:
bianco, oro, grafite



Rituals XL semi
net kg 4,20

Collection →

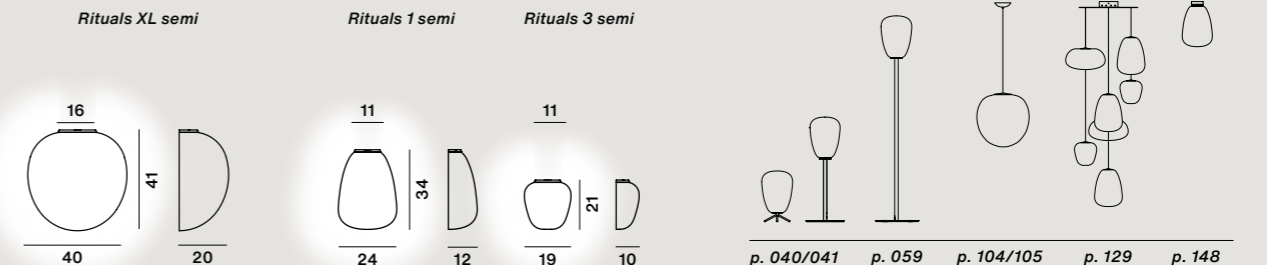

Satellight

Parete / Wall

Eugeni Quitllet, 2017



	colours	code	€
Satellight G9	bianco/trasparente	FN285025E_15	471,00

Hand-blown crystal glass and cased acid-etched glass, lacquered aluminium

Max 1x25W G9

⊕ CE IP 20

Colours: bianco / trasparente



Weight: net kg 2,00

Light bulbs not included → specifications p. 196

Collection →

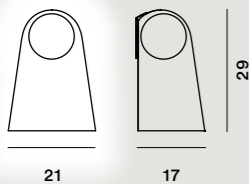

p. 042



p. 106

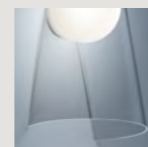

Tobia

LED

Parete / Wall

Ferruccio Laviani, 2019



	colours	code	€
Tobia with plug	bianco	FN294005_10	633,00
	nero	FN294005_20	
	arancio	FN294005_53	688,00
	giallo	FN294005_55	
	oro	FN294005_71	825,00
Tobia	bianco	FN294005P_10	764,00
	nero	FN294005P_20	
	arancio	FN294005P_53	819,00
	giallo	FN294005P_55	
	oro	FN294005P_71	956,00

Liquid varnished or gold painted metal and aluminum

LED included
12 (6+6)W 2700 K
1400 lm CRI > 80

Tobia with plug
white cable

⊕ CE IP 20

☐ Tobia with plug

⊕ Tobia

Colours: bianco, nero, arancio fluo, giallo fluo, oro

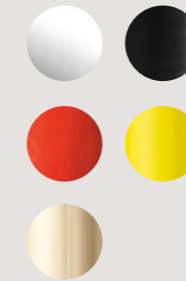

Weight: **Tobia with plug**
net kg 1,50

Tobia
net kg 1,70

This product contains an energy efficiency class E light source

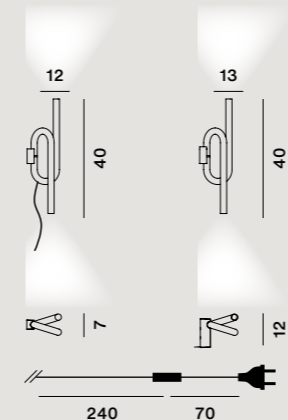

Collection →



p. 060

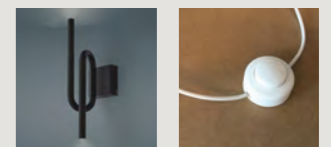

Tress

Parete / Wall

Marc Sadler, 2011



	colours	code	€
Tress grande	bianco	FN182005_10	553,00
	nero	FN182005_20	
Tress piccola	bianco	FN1820052_10	500,00
	nero	FN1820052_20	

Coated fibreglass-based composite material and coated metal

Max 1x120W R7s

⚡ CE IP 20

Colours:
bianco, nero



Weight:
Tress grande
net kg 1,10

Tress piccola
net kg 1,00

Light bulbs not included
→ specifications p. 196

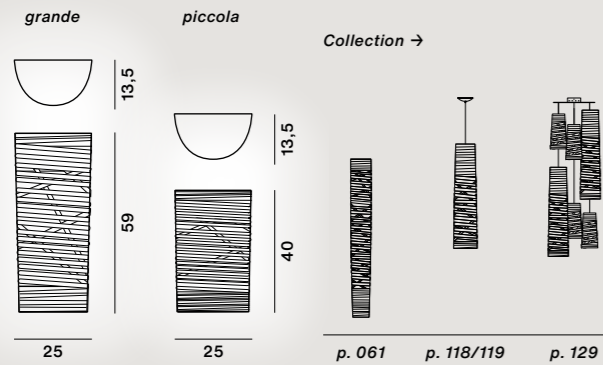

Tutù

Parete / Wall

Valerio Bottin, 2001



	colours	code	€
Tutù	bianco	FN114005I_11	253,00
	**avorio	FN114005I_51	

Hand-blown cased glass,
metal and aluminium

Max 2x46W E14

⚡ CE IP 20

Colours:
bianco, avorio



Weight:
net kg 0,80

Light bulbs not included
→ specifications p. 196

**
Limited stock available

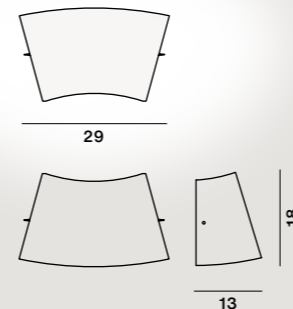

Aplomb

Lucidi e Pevere

→ Technical info p. 188



Index

Outdoor

188	Aplomb	190	Havana sosp. / <i>susp.</i>
182	Cri Cri	185	Solar
189	Gregg sosp. / <i>susp.</i>	187	Twiggy Grid XL - Lettura
183	Gregg terra / <i>floor</i>	186	Twiggy Grid terra / <i>floor</i>
193	Gregg	191	Twiggy Grid sosp. / <i>susp.</i>
184	Havana terra / <i>floor</i>	192	Uto

Studio Natural, 2017



	colours	code	€
<i>Cri Cri</i>	verde	FN286001_40	428,00
	rosso	FN286001_63	

Silicone, ABS and PMMA

LED 2,4W 2700 K
325 lumen CRI>80
Integrated touch-dimmer
USB charge - cable included
Charger (not included) 1 A
Charge lifetime approx. 10 hours (highest power)
Recharging time approx. 9 hours
Cicles of recharge 500/700

CE IP 67

Colours:
verde, rosso



Weight:
net kg 1,00

Assembly tutorial:



tutorial.foscarini.com/cricri

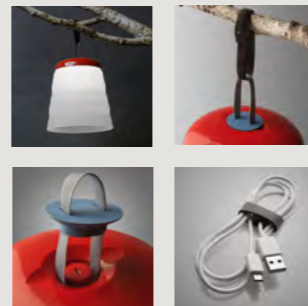
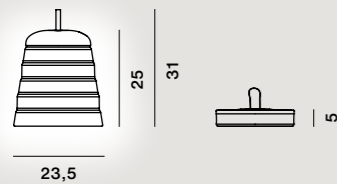

Ludovica + Roberto Palomba, 2011

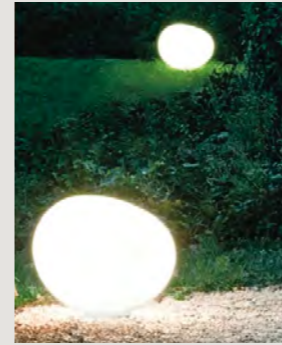

	colours	code	€
<i>Gregg Outdoor X-large</i>	bianco	FN218003_10	439,00
<i>Gregg Outdoor grande</i>	bianco	FN218013_10	334,00
<i>Gregg Outdoor media</i>	bianco	FN218023_10	257,00

Rotational moulded
polyethylene and coated
metal

Colours:
bianco



Weight:
X-large
net kg 4,30

Light bulbs not included
→ specifications p. 196

X-large / grande
Max 1x25W E27

grande
net kg 3,60

media
Max 1x15W E27

media
net kg 1,60

Black cable

CE IP 65 - IP 44

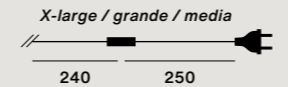
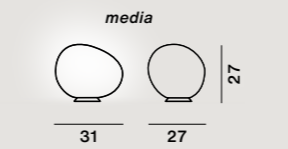
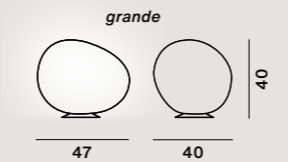
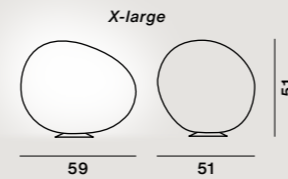

Collection →

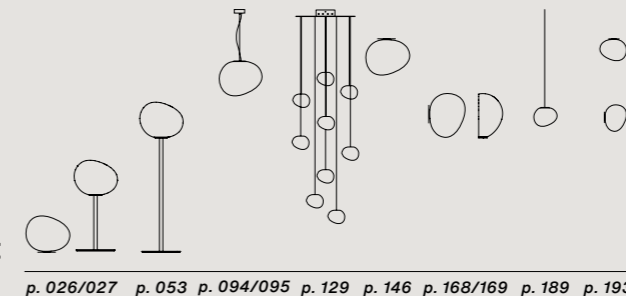

IP 44

IP 65



p. 026/027 p. 053 p. 094/095 p. 129 p. 146 p. 168/169 p. 189 p. 193

Jozeph Forakis, 2005

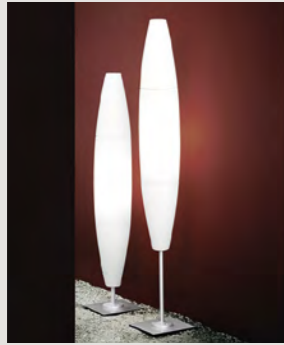

	colours	code	€
Havana Out. terra undergr. base	bianco	FN150003_10	878,00
Havana Out. terra stake mounted	bianco	FN1500031_10	737,00
Havana Out. terra base	bianco	FN1500032_10	787,00
Havana Out. terra bassa undergr. base	bianco	FN150004_10	854,00
Havana Out. terra bassa stake mounted	bianco	FN1500041_10	715,00
Havana Out. terra bassa base	bianco	FN1500042_10	764,00

Rotational moulded polyethylene and coated metal

Max 1x46W E27

Black cable

CE IP 65 - IP 44

Colours: bianco



Weight: Underground base net kg 5,50

Stake mounted net kg 5,20

Base net kg 10,10

Light bulbs not included → specifications p. 196

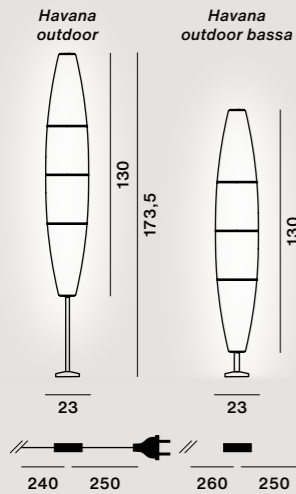
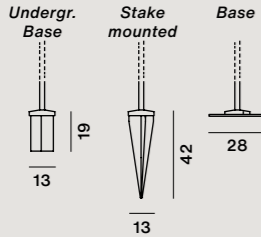

Collection →

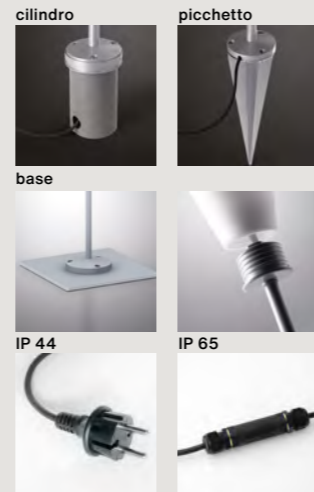
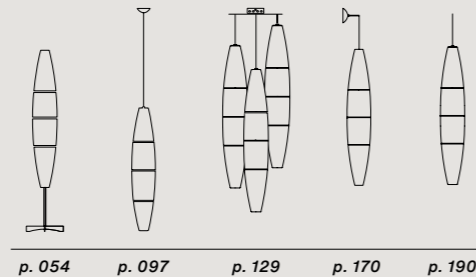

Jean Marie Massaud, 2011

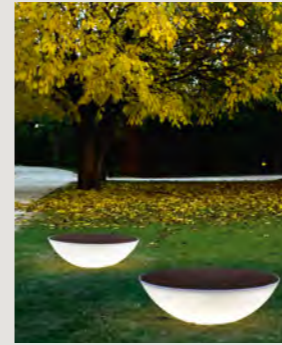

	colours	code	€
Solar	marrone	FN228003M	1.047,00

Rotational moulded polyethylene, porcelain stoneware top shelf and coated metal

Max 1x25W E27

Reclinable up to 15°

Black cable

CE IP 65 - IP 44

Colours: marrone



Weight: net kg 11,70

Light bulbs not included → specifications p. 196

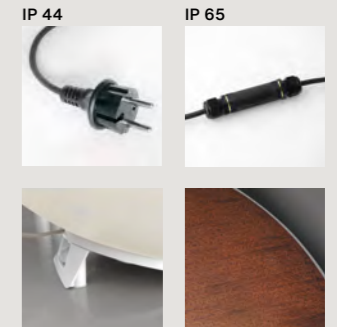
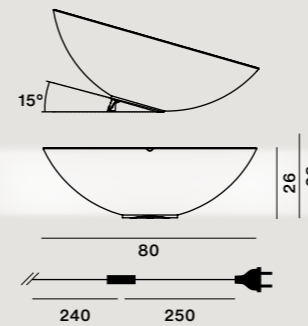

Twiggy Grid



Outdoor - Terra / Floor

Marc Sadler, 2017



	colours	code	€
Twiggy Grid	greige	FN290003_25	2.816,00
	carminio	FN290003_65	
Accessories:			
Additional stem set	greige	FN1590031_25	262,00
Twiggy Grid (40 cm + 40 cm)	carminio	FN1590031_65	

Varnished fibreglass based composite material, PMMA, varnished metal and aluminium

Colours: greige, carminio



Weight: net kg 17,10

This product contains an energy efficiency class E light source

LED included
32W 2850 K
3930 lm CRI>90
On/off

Black cable

☐ CE IP 44 - IP 65

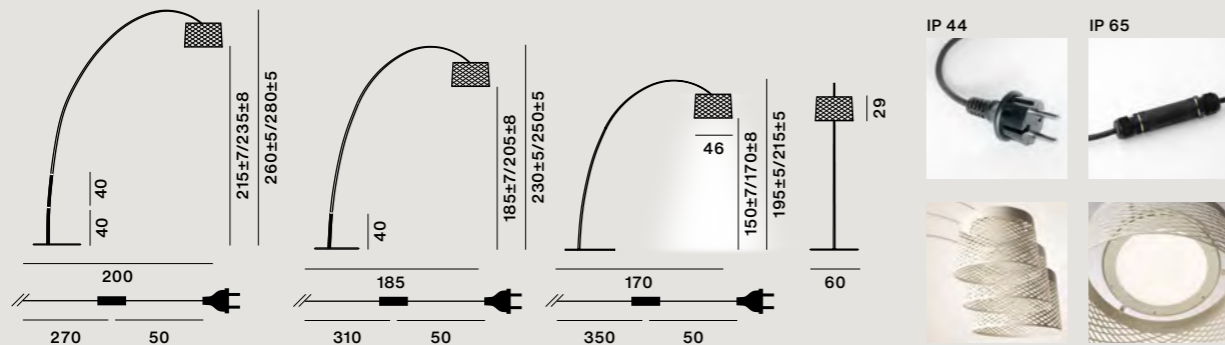

Twiggy Grid Lettura + XL



Outdoor - Terra / Floor

Marc Sadler, 2018



	colours	code	€
Twiggy Grid lettura	greige	FN290004_25	2.135,00
	carminio	FN290004_65	
Twiggy Grid XL	greige	FN2900011_25	1.909,00
	carminio	FN2900011_65	

Varnished fibreglass based composite material, PMMA, varnished metal and aluminium

Colours: greige, carminio



Weight: **Twiggy Grid lettura** net kg 12,00

Twiggy Grid XL net kg 7,50

This product contains an energy efficiency class E light source

LED included
32W 2850 K
3930 lm CRI>90
On/off

Black cable

☐ CE IP 44 - IP 65

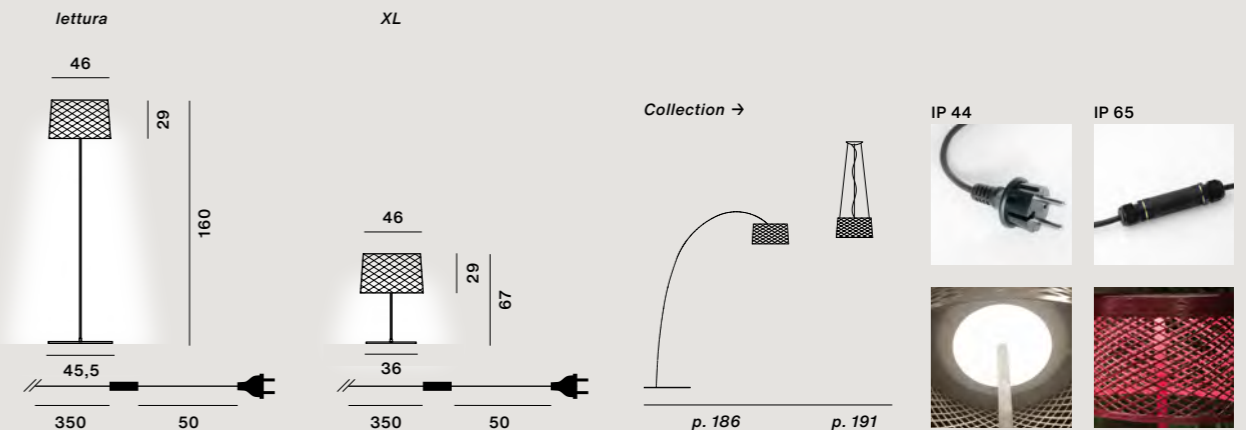

Lucidi e Pevere, 2017



	colours	code	€
Aplomb outdoor	grigio	FN291007_26	494,00
	verde	FN291007_42	
	rosso	FN291007_65	
Accessories:			
Cable reel kit outdoor		FN291KIT_AVV	127,00

Hand pouring concrete and aluminium

LED included
8W 2700 K
680 lm CRI>90

Dimmable with TRIAC technology

Canopy not included

Black cable

☐ CE ⚡ IP 44 - IP 65

Colours: grigio chiaro, verde salvia, rosso pompeiano
Weight: net kg 1,90

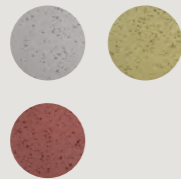

This product contains an energy efficiency class G light source

LED and dimming
→ specifications p. 195

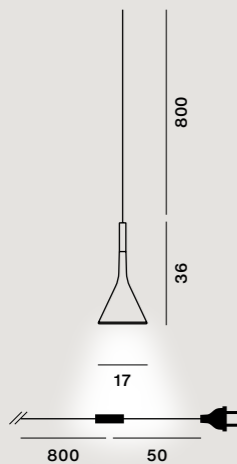

Collection →

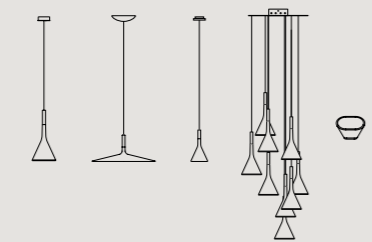

p. 074 p. 075 p. 076 p. 129 p. 154

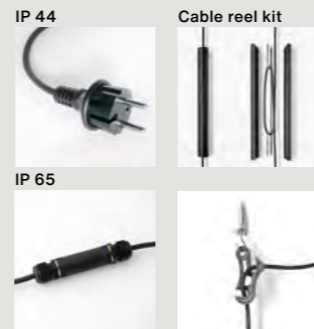

Ludovica + Roberto Palomba, 2011



	colours	code	€
Gregg Outdoor X-large	bianco	FN218007_10	409,00
Gregg Outdoor grande	bianco	FN218017_10	305,00
Gregg Outdoor media	bianco	FN218027_10	245,00
Gregg Outdoor X-large h. 10 m *	bianco	FN218007-10_10	514,00
Gregg Outdoor grande h. 10 m *	bianco	FN218017-10_10	409,00
Gregg Outdoor media h. 10 m *	bianco	FN218027-10_10	350,00
Accessories:			
Cable reel kit outdoor		FN291KIT_AVV	127,00

Rotational moulded polyethylene and coated metal

Colours: bianco



Weight: X-large net kg 3,70

Light bulbs not included
→ specifications p. 196

X-large / grande
Max 1x25W E27

grande
net kg 3,00

*
On demand:
lead times to be checked with the sales department

media
Max 1x15W E27

media
net kg 1,40

Canopy not included

Black cable

☐ CE ⚡ IP 65 - IP 44

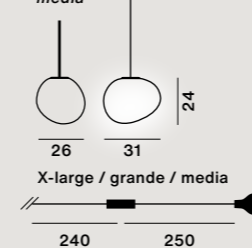
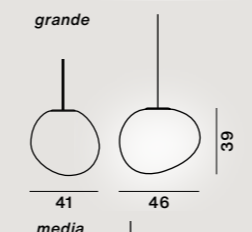
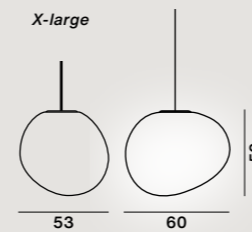

Collection →

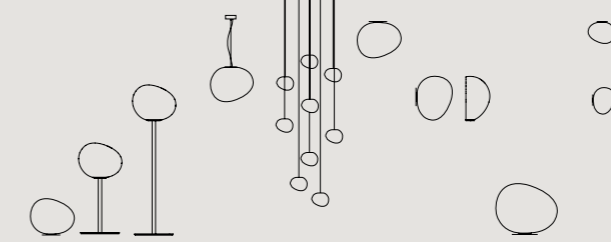

p. 026/027 p. 053 p. 094/095 p. 129 p. 146 p. 168/169 p. 183 p. 193

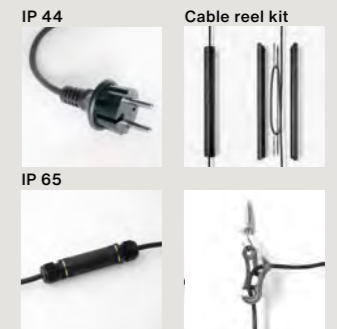

Jozeph Forakis, 2005



	colours	code	€
Havana Outdoor sospensione	bianco	FN150007_10	468,00
Havana Outd. sosp. h. 10 m *	bianco	FN150007_10SP10	631,00
Accessories:			
Cable reel kit outdoor		FN291KIT_AVV	127,00

Rotational moulded polyethylene and coated metal

Max 1x46W E27

Canopy not included

Black cable

☐ CE ⚡ IP 65 - IP 44

Colours:
bianco



Weight:
net kg 3,00

Light bulbs not included
→ specifications p. 196

*

On demand:
lead times to be checked
with the sales department

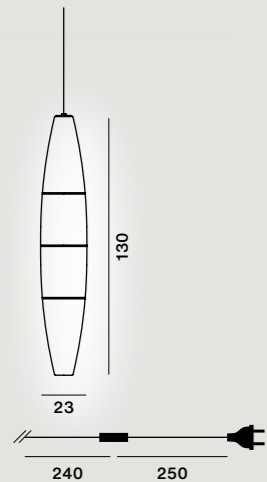

Collection →

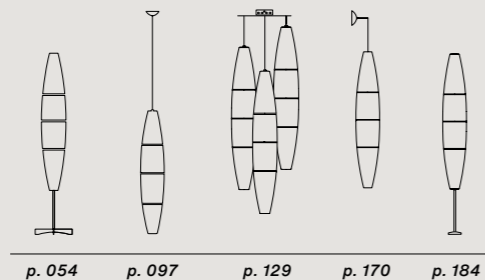

IP 44

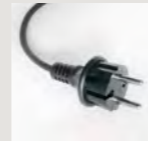

Marc Sadler, 2017



	colours	code	€
Twiggy Grid	greige	FN290007_25	1.802,00
	carminio	FN290007_65	
Twiggy Grid h. 10 m *	greige	FN290007-10_25	1.833,00
	carminio	FN290007-10_65	

Varnished fibreglass based composite material, PMMA, varnished metal and aluminium

LED included
26W 2850K
3368 lm CRI>90

Black cable

⚡ CE ⚡ IP 44

Colours:
greige, carminio



Weight:
net kg 2,80

This product contains an energy efficiency class E light source

*

On demand:
lead times to be checked with the sales department

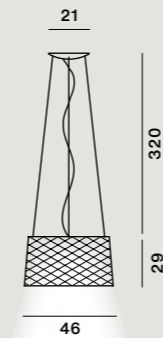

Collection →

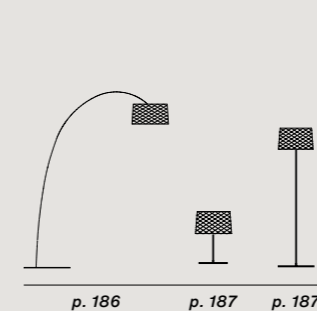

Uto

Outdoor - Sospensione / Suspension

Lagranja Design, 2005



	colours	code	€
Uto	bianco	FN142000_10	489,00
	giallo	FN142000_50	
	arancio	FN142000_53	

Thermoplastic elastomer and polycarbonate

Max 1x12W E27

Switch inside the flexible tube

☐ CE ⚡ IP 44

Colours: bianco, giallo, arancio



Weight: net kg 2,00

Light bulbs not included → specifications p. 196

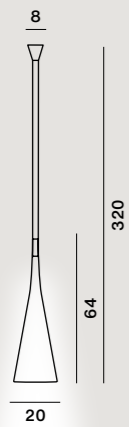

Collection →



p. 124

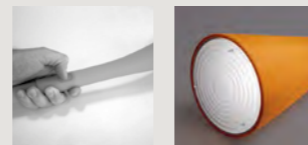

Gregg Outdoor

Outdoor - Parete, Soffitto / Wall, Ceiling

Ludovica + Roberto Palomba, 2017



	colours	code	€
Gregg Outdoor MIDI	bianco	FN1680053R1_10	311,00
Gregg Outdoor piccola	bianco	FN168025W_10	156,00

Hand blown acid-etched glass and coated metal or polycarbonate

Gregg MIDI ^{LED}
LED included
8W 2700 K
635 lm CRI>90
Dimmable with TRIAC technology

☐ CE ⚡ IP 44

Gregg piccola
Max 1x8W LED retrofit G9

☐ CE ⚡ IP 44

Glass colours: bianco



Weight: **Gregg MIDI** net kg 1,60

Gregg piccola net kg 0,60

This product contains an energy efficiency class G light source

LED and dimming → specifications p. 195

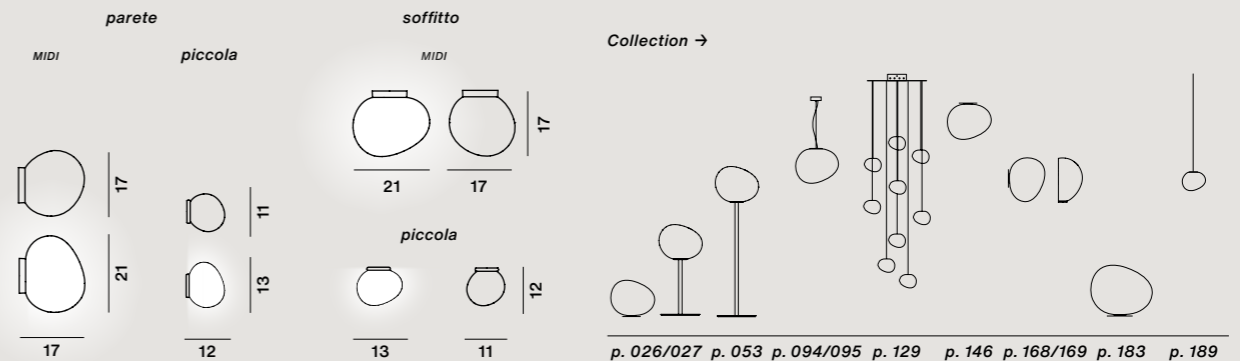

p. 026/027 p. 053 p. 094/095 p. 129 p. 146 p. 168/169 p. 183 p. 189

MyLight Collection

The MyLight models use the smart device Casambi to control light intensity from 100% to complete turning off.

The system is easy and user-friendly. No new wiring, switch, device or Internet connection is needed.

You only need to install the light source and match it through Bluetooth with your smart phone, tablet, or other control devices (see below). No further configurations by qualified staff are needed.

Tunable White - Caboche Plus and Twiggy

Besides light intensity control, it's possible to control the LED light colour degree from 2700 K to 5000 K, from warm to natural or cold light through any intermediate level.

Models with LED module and Casambi interface integrated

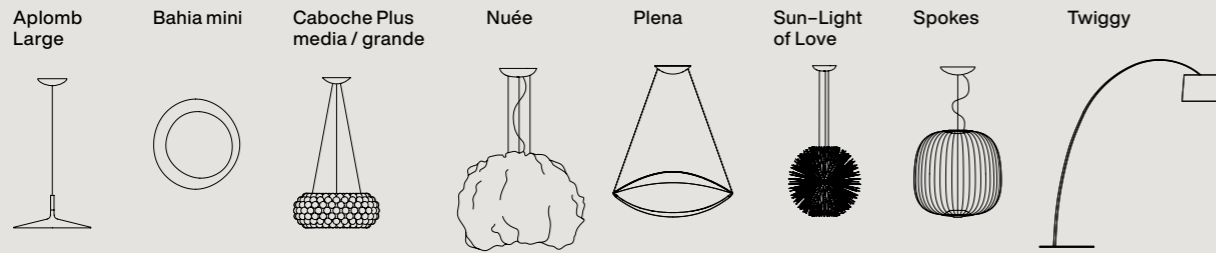

Models with line voltage LED or E27 retrofit LED and Casambi interface aside

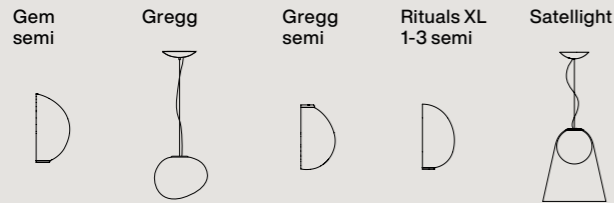

Controlled via Bluetooth / Casambi App [iOS / Android]

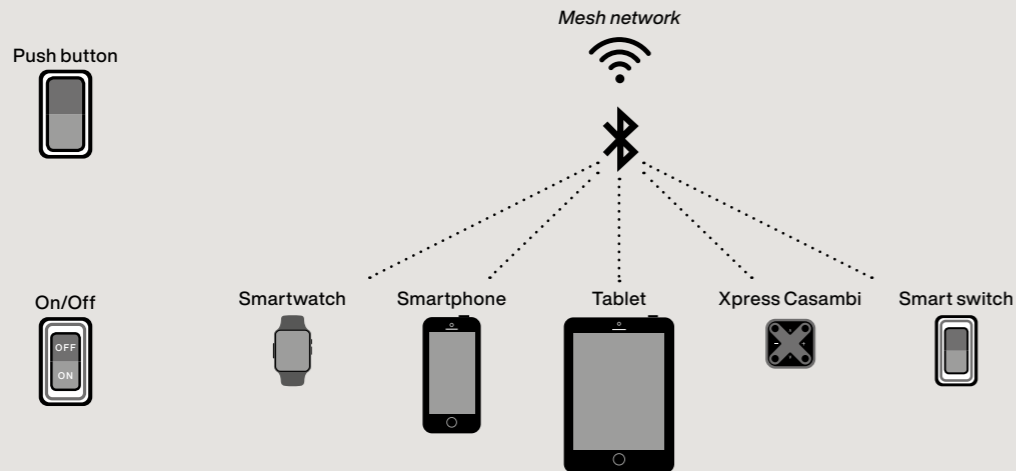

LED and dimming

Spare parts for lights with LED included

LED modules can be replaced by qualified staff on-the-spot and the spare part can be purchased to the company for the following lights: Allegro, Aplomb Large, Bahia, Bahia mini, Big Bang, Big Bang L, Big Bang XL, Caboche Plus, Chouchin, Chouchin Reverse, Gem, Gregg media, Lake, Le Soleil, Rituals XL, Satellight, Tartan, Tress grande, Tuareg, Twiggy, Twice as Twiggy.

Dimming

The following lights can be dimmed with On/Off - Push - DALI configurations: Allegro, Aplomb Large, Bahia, Bahia mini, Big Bang, Big Bang L, Big Bang XL, Buds LED included, Caboche Plus grande e media, Chouchin, Chouchin Reverse LED included, Dolmen, Gregg grande, Gregg media LED included, Le Soleil, Lumiere XXL/S, Plena, Rituals XL LED included, Spokes 1, Spokes 2, Spokes 3, Tartan LED included, Tress grande, Troag, Twice as Twiggy, Twiggy Wood.

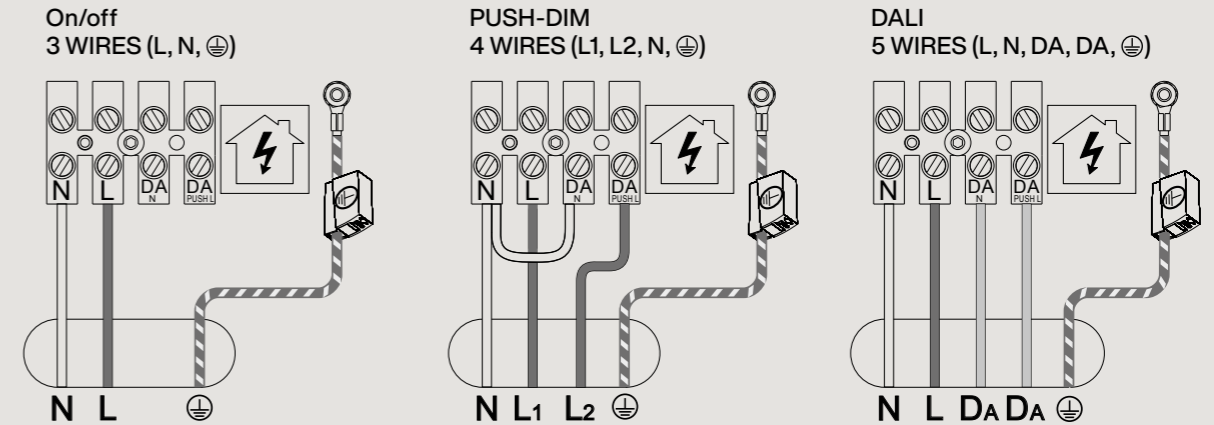

N = Neutro
L = Linea
DA = Dali
PUSH = Dimmerabile Push

The LED retrofit bulb included for the following lights is dimmable with TRIAC* technology: Buds, Chouchin, Gem, Gregg grande, Gregg media, Rituals XL, Satellight, Tartan.

* The minimum power output (Watt) adjustable by the recessed light dimmer has to be lower than the light or the LED retrofit bulb power.

Light Sources

LED retrofit light bulbs: Foscarini recommends the use of warm light bulbs for its whole collection. The light bulbs available on the market may feature technical specifications with various graphics and definitions, but a warm light tone is generally described as Warm White - 2700- 3000K° and CRI > 80.

Lamps with dimmer: Please verify the compatibility of your bulb with the dimmer's wattage ranges, indicated on the dimmer itself, according to the kind of light source

This table contains the necessary information to purchase the correct light source (models with integrated LED excluded).

Model	Version	Type	Fitting Base	Lenght*	Width*	Notes
<i>Allegretto</i>	sospensione	LED retrofit	E27-PAR	max 85	Ø96	
<i>Allegro</i>	sospensione	LED retrofit	E27-PAR	max 99 (E27 PAR)	Ø96	
<i>Allegro</i>	sospensione	LED retrofit /halo	R7s	118 (R7s)	max Ø 40 R7s	
<i>Aplomb - Aplomb mini</i>	sospensione	LED retrofit	GU10-PAR	max 80	Ø80	
<i>Aplomb</i>	parete	LED retrofit		118	max Ø 40	
<i>Big Bang</i>	sospensione	LED retrofit	R7s	118	max Ø23	
<i>Big Bang</i>	soffitto/parete	LED retrofit	R7s	78	max Ø35	
<i>Binic</i>	tavolo	LED retrofit	E14	max 80	max Ø45	
<i>Birdie piccolo</i>	tavolo/sospensione / parete	LED retrofit	E27	max 110	max Ø60	
<i>Birdie grande</i>	tavolo / lettura / sospensione	LED retrofit	E27	max 135	max Ø70	
<i>Birdie Easy</i>	tavolo	LED retrofit	E27	max 110	max Ø60	
<i>Birdie Easy Grande</i>	tavolo	LED retrofit	E27	max 135	max Ø70	
<i>Birdie Zero piccola</i>	tavolo	LED retrofit	E27	max 110	max Ø60	
<i>Birdie Zero grande</i>	tavolo	LED retrofit	E27	max 135	max Ø70	
<i>Bit</i>	parete	LED retrofit	E14	max 80	max Ø45	
<i>Buds 12</i>	tavolo/sospensione	LED retrofit	E27	max 140	max Ø120	
<i>Buds 3</i>	tavolo/sospensione	LED retrofit	E27	max 140	max Ø95	
<i>Bump</i>	sospensione	LED retrofit	E27	max 143	max Ø120	
<i>Caboche</i>	sospensione	LED retrofit	R7s	118	max Ø35	
<i>Caboche</i>	parete	LED retrofit	R7s	118	max Ø29	
<i>Chouchin 1-2-3 & Reverse</i>	sospensione	LED retrofit	E27/E27 PAR	max 143	max Ø95	
<i>Chouchin 23</i>	soffitto	LED retrofit	E27	max 140	max Ø70	
<i>Chouchin semi</i>	parete	LED retrofit	E27	max 140	max Ø70	
<i>Circus grande</i>	soffitto/parete	LED retrofit	E27	max 107	max Ø60	
<i>Circus piccola</i>	soffitto/parete	LED retrofit	E14	max 80	max Ø45	
<i>Double</i>	parete	LLED retrofit	E27	max 106	max Ø67	
<i>Fields 1-2-3</i>	parete	Fluo	G5	1449/1149/849	Ø16	
<i>Filo</i>	tavolo/lettura/parete	LED retrofit	G9	max 65	max Ø18	
<i>Folio grande piccola</i>	soffitto/parete	LED retrofit	R7s	78	max Ø35	
<i>Gem</i>	parete semi	LED retrofit	E27	max 140	max Ø70	
<i>Gem</i>	tavolo/sospensione	LED retrofit	E27	max 140	max Ø70	
<i>Gem</i>	tavolo alta/terra	LED retrofit	E27	max 140	max Ø67	
<i>Gem</i>	soffitto	LED retrofit	E27	max 140	max Ø80	
<i>Gregg grande /media</i>	parete semi	LED retrofit	E27	max 140	max Ø70	
<i>Gregg grande</i>	sospensione	LED retrofit	E27		max Ø120	
<i>Gregg grande</i>	tavolo/tavolo alta/ terra	LED retrofit	E27	max 143	max Ø67	
<i>Gregg grande</i>	soffitto	LED retrofit	E27	max 140	max Ø80	
<i>Gregg media</i>	tavolo/ tavolo alta/terra	LED retrofit	E27	max 143	max Ø67	
<i>Gregg media</i>	sospensione	LED retrofit	E27	max 145	max Ø80	
<i>Gregg media</i>	parete/ soffitto	LED retrofit	E27	max 140	max Ø80	
<i>Gregg Midi</i>	tavolo/sospens./parete/soff.	LED retrofit	E14	max 80	max Ø45	
<i>Gregg piccola</i>	tavolo/sosp./soffitto/parete	LED retrofit	G9	max 60	max Ø20	
<i>Havana</i>	terra/sospensione/parete	LED retrofit	E27	max 145	max Ø80	

Light Sources

* Expressed in mm

Model	Version	Type	Fitting Base	Lenght*	Width*	Notes
<i>Havana outdoor</i>	terra/sospensione	LED retrofit	E27	max 143	max Ø67	
<i>Kurage</i>	tavolo	LED retrofit	E27	max 135	max Ø67	
<i>Le Soleil</i>	sospensione	LED retrofit	E27/GU10 PAR	max 145	max Ø80	
<i>Le Soleil</i>	parete	LED retrofit	R7s	118	max Ø29	
<i>Lightweight</i>	sospensione	Halo	G4 12v		//	
<i>Lumiere grande</i>	tavolo	LED retrofit	E27	max 107	max Ø60	
<i>Lumiere piccola</i>	tavolo	LED retrofit	E14	max 80	max Ø45	
<i>Lumiere XXL XXS</i>	tavolo	LED retrofit	G9	max 60	max Ø20	
<i>Lumiere XXL /XXS</i>	soffitto/parete	LED retrofit	G9	max 60	max Ø20	
<i>Mite</i>	terra	LED retrofit	E27	max 140	max Ø67	
<i>Nile</i>	tavolo	LED retrofit	E27	max 128	max Ø80	
<i>Orbital</i>	terra	LED retrofit	E14	max 80	max Ø45	
<i>Palomar</i>	terra	LED retrofit / Fluo	E27-PAR	max 85	max Ø64	
<i>Plass media</i>	tavolo/sospensione	LED retrofit / Fluo / Halo	E27	max 107	max Ø67	
<i>Plass media</i>	sospensione	LED retrofit	GU10 PAR		max Ø55	
<i>Plass media</i>	sospensione	LED retrofit	GU10 PAR		max Ø55	
<i>Plass grande</i>	sospensione	Halo	G9/GU10 PAR		max Ø80 <small>GU10 PAR</small>	
<i>Polygregg grande XL</i>	tavolo	LED retrofit	E27	max 107	max Ø60	
<i>Gregg outdoor XL grande</i>	tavolo/terra out./sosp. out.	LED retrofit	E27	max 107	max Ø60	
<i>Polygregg media</i>	tavolo	LED retrofit	E27	max 110	max Ø60	
<i>Gregg outdoor media</i>	tavolo/terra out./sosp. out.	LED retrofit	E27	max 110	max Ø60	
<i>Rituals 1</i>	tavolo alta/terra	LED retrofit	E27	max 140	max Ø67	
<i>Rituals 1- 2</i>	tavolo/sospensione	LED retrofit	E27	max 140	max Ø80	
<i>Rituals 3</i>	tavolo/sospensione /parete	LED retrofit	E27	max 107	max Ø60	
<i>Rituals 123</i>	soffitto	LED retrofit	E27	max 107	max Ø70	
<i>Rituals 1-2</i>	tav./ter./sosp./soffitto/parete	LED retrofit	E27	max 110	max Ø63	
<i>Rituals 3 semi</i>	parete	LED retrofit	E27	max 77	max Ø45	
<i>Rituals XL</i>	tavolo/ tavolo alta/terra	LED retrofit	E27	max 143	max Ø67	
<i>Rituals XL</i>	sospensione/soffitto	LED retrofit	E27	max 143	max Ø70	
<i>Satellight</i>	sospensione	LED retrofit / Halo	E27	max 145	max Ø70	
<i>Satellight</i>	parete	LED retrofit	G9	max 73	max Ø20	
<i>Solar</i>	outdoor	LED retrofit / Fluo	E27	max 140	max Ø67	
<i>Supernova</i>	sospensione	LED retrofit / Fluo	E27	globo bianco max Ø120		
<i>Tartan</i>	sospensione/soffitto	LED retrofit	E27	max 143	max Ø70	
<i>Tite</i>	sospensione	LED retrofit	E27	max 143	max Ø70	
<i>Tress grande</i>	sospensione	LED retrofit / Halo	R7s	118	max Ø35	
<i>Tress</i>	parete	LED retrofit / Halo	R7s	78	max Ø35	
<i>Tress media/piccola</i>	terra/sospensione	LED retrofit	E27/E27 PAR		max Ø150	
<i>Tress grande</i>	terra	Halo / LED retrofit	R7s/E27 PAR	118 (R7s)	max Ø35 R7s	
<i>Tress mini</i>	sospensione	Halo / LED retrofit	GU10-PAR		max Ø150	
<i>Tutù</i>	parete	LED retrofit	E14	max 80	max Ø45	
<i>Twiggy</i>	tav./ter./lettura/sosp./soffitto	LED retrofit	E27	max 143	max Ø70	
<i>Uto</i>	sospensione/outdoor	LED retrofit	E27	max 143	max Ø70	

Spare parts

model	version	description	code	vat excluded	
Allegro	suspension	halogen protection glass	CRRPIREX138-4	46,00	
	table	halogen protection glass	FR203V01	87,00	
Big Bang	<i>code and price of the single plates to request to the customer service</i>				
	suspension	halogen protection glass	CRRPIREX180_50	44,00	
	ceiling/wall	halogen protection glass	CRRPIREX94-4	36,00	
Birdie	grande	table/lettura	lampshade bianco	FR221S00_10	118,00
			lampshade grigio	FR221S00_25	
			lampshade verde acqua	FR221S00_42	
			lampshade grafite	FR221S00_22	237,00
			lampshade rame	FR221S00_80	
	piccolo	table/susp./wall	lampshade bianco	FR221S002_10	83,00
			lampshade grigio	FR221S002_25	
			lampshade verde acqua	FR221S002_42	
		table	lampshade grafite	FR221S002_22	184,00
			lampshade rame	FR221S002_80	
Buds	table/suspension	glass 1 bianco caldo	FR278S001_12	637,00	
		glass 2 bianco caldo	FR278S002_12	690,00	
		glass 2 grigio	FR278S002_24		
		glass 3 bianco caldo	FR278S003_12	585,00	
		glass 3 verde bambù	FR278S003_40		
	suspension LED	glass 1 bianco caldo	FR278S0071_12	637,00	
		glass 2 bianco caldo	FR278S0072_12	690,00	
		glass 2 grigio	FR278S0072_24		
		glass 3 bianco caldo	FR278S0073_12	585,00	
		glass 3 verde bambù	FR278S0073_40		
Caboche *	grande	floor/suspension	kit 20 prongs 4 spheres	FR138KIT20G4	64,00
		floor/suspension	kit 20 prongs 5 spheres	FR138KIT20G5	
		floor/suspension	kit 3 +3 prongs 4 /5 spheres	FR138KIT1_R2	36,00
		floor/suspension	glass grande	FR138V011	209,00
		floor/suspension	halogen protection disk	FR138V021	86,00
		suspension	glass grande LED	FR138V0118	206,00
	grande/media	floor/suspension	halogen protection glass	CRRPIREX138-2S4	36,00
		media	ceiling	kit 15 prongs 4 spheres	FR138KIT15S4
	ceiling		kit 3 +3 prongs 3/4 spheres	FR138KIT3_R2	30,00
		floor/susp./wall	kit 3 +3 prongs 3/4 spheres	FR138KIT_R2	36,00
		floor/suspension	kit 15 prongs 3 spheres	FR138KIT15M3	51,00
		floor/suspension	kit 15 prongs 4 spheres	FR138KIT15M4	
		floor/suspension	glass media	FR138V01R1	138,00
		floor/suspension	halogen protection disk	FR138V02	64,00
	media LED/soff.	suspension LED/ceil.	glass media	FR138V018	158,00
piccolo		table./susp./wall	kit 10 prongs 3 spheres	FR138KIT10P3	43,00
	table./susp./wall	kit 10 prongs 4 spheres	FR138KIT10P4		
	table./susp./wall	kit 3 +3 prongs 3 /4 spheres	FR138KIT2_R2	30,00	
	table/suspension	glass piccolo	FR138V012	74,00	
media/piccola	wall	glass	FR138V052	112,00	
	wall	halogen protection glass	CRRPIREX94-4	36,00	
		kit 10 spheres trasparente	FR138KIT10SF16	68,00	
		kit 10 spheres giallo oro	FR138KIT10SF52		
* The spare parts refer only to the previously existing Caboche version, they are not compatible with the new Caboche Plus					
Chouchin	suspension	glass 1 arancio	FR210S001E_53	644,00	
		glass 2 verde	FR210S002E_40	572,00	
		glass 3 grigio	FR210S003E_25	474,00	
	suspension LED	glass 1 LED arancio	FR210S001R1_53	644,00	
		glass 2 LED verde	FR210S002R1_40	572,00	
		glass 3 LED grigio	FR210S003R1_25	474,00	
	bianco	suspension	glass 1 arancio	FR210S001E_11	527,00
			glass 2 verde	FR210S002E_11	470,00
			glass 3 grigio	FR210S003E_11	376,00
	suspension LED	glass 1 LED arancio	FR210S001R1_11	527,00	
glass 2 LED verde		FR210S002R1_11	470,00		
glass 3 LED grigio		FR210S003R1_11	376,00		

Spare parts

model	version	description	code	vat excluded		
Chouchin	Reverse	suspension	glass 1 reverse arancio	FR210S001E_05	644,00	
			glass 2 reverse verde	FR210S002E_04	572,00	
			glass 3 reverse grigio	FR210S003E_02	474,00	
			suspension LED	glass 1 reverse LED arancio	FR210S001R1_05	644,00
				glass 2 reverse LED verde	FR210S002R1_04	572,00
		glass 3 reverse LED grigio	FR210S003R1_02	474,00		
Chouchin semi	wall	glass semi bianco	FR210S053_11	243,00		
Circus	piccolo	ceiling/wall	glass piccola bianco	FR046S00_11	261,00	
	grande		glass grande bianco	FR046S001_11	469,00	
Double	wall	glass bianco	FR069S00_11	274,00		
Fields	<i>code and price of the single plates to request to the customer service</i>					
Folio	piccolo	wall	glass piccola bianco	FR019S00_10	227,00	
	grande	ceiling/wall	glass grande bianco	FR019S001_10	367,00	
			halogen protection glass	CRRPIREX94-4	36,00	
Gem	table/suspension	glass	FR274S00_10	440,00		
		suspension LED	glass	FR274S007_10		
	table alta/floor	glass	FR274S003_10			
		glass	FR274S005_10	328,00		
		wall semi	glass	FR274S001_20	664,00	
Giga-Lite	sospensione	diffusore	FR139S001_20	664,00		
Gregg	grande	table/susp. LED	glass grande	FR168S001_10	568,00	
		table alta/floor	glass grande	FR168S0031_10		
		suspension	glass grande	FR168S001E_10		
		wall semi	glass grande semi 1	FR168S01511_10	368,00	
		wall semi	glass grande semi 2	FR168S01512_10		
	media	table./susp./cel./wall	glass media	FR168S00_10	306,00	
		table alta/floor	glass media	FR168S0030_10		
		suspension	glass media	FR168S00E_10		
		suspension LED	glass media LED	FR168S007R1_10		
		wall semi	glass media semi 1	FR168S0151_10	214,00	
	wall semi	glass media semi 2	FR168S0152_10			
	mini	table./susp./cel./wall	glass midi	FR168S003_10	155,00	
	piccolo	table./susp./cel./wall	glass piccolo	FR168S00210	102,00	
Gregg outdoor	media	floor/suspension	lampshade media	FR218S002_10	108,00	
Polygregg	grande		lampshade grande	FR218S00_10	175,00	
		XL	lampshade XL	FR218S001_10	312,00	
Havana	floor/susp./wall	set lampshades	FR040S00_10	138,00		
Havana outdoor	floor	stake mounted	FR150S031	193,00		
		underground base	FR150S032	209,00		
		base	FR150S033_R1	257,00		
		floor/suspension	lampshade	FR150S00_10	273,00	
		table	lampshade	FR258S00_10	290,00	
Kurage	suspension	lampshade	FR061V01	39,00		
Lightweight	<i>code and price of the single plates to request to the customer service</i>					
Le Soleil	grande	table - G9 until 2021	glass grande bianco	FR026S00_11	324,00	
Lumiere	grande		glass grande bianco caldo	FR026S00_12	427,00	
			glass grande turchese	FR026S00_32		
			glass grande ciliegia	FR026S00_62		
			glass grande 30th bulles	FR026S00_13	472,00	
			glass grande 30th pastilles	FR026S00_14		
Lumiere	grande	tavolo - E27 from 2022	glass grande bianco	FR026S00E_11	324,00	
			glass grande bianco caldo	FR026S00E_12	427,00	
			glass grande bulles	FR026S00E_13	472,00	
			glass grande pastilles	FR026S00E_14		
			glass grande creta	FR026S00E_26	427,00	
		glass grande shara	FR026S00E_58			
		glass grande cipria	FR026S00E_61			
		glass grande ciliegia	FR026S00E_62			
	piccolo	table	glass piccolo bianco	FR026S002R_11	183,00	
			glass piccolo bianco caldo	FR026S002R_12	282,00	
glass piccolo turchese			FR026S002R_32			
glass piccolo ciliegia			FR026S002R_62			

Spare parts

model	version	description	code	vat excluded				
<i>Lumiere</i>	<i>piccolo</i>	table	glass piccolo 30th bulles	FR026S002R_13	315,00			
			glass piccolo 30th pastilles	FR026S002R_14				
			glass piccolo creta	FR026S002R_26				
			glass piccolo shara	FR026S002R_58				
			glass piccolo cipria	FR026S002R_61				
<i>Lumiere XX</i>	<i>XXL</i>	table/lettura	glass XXL bianco	FR191S001_11	618,00			
			glass XXL grigio	FR191S001_24				
			glass XXL bianco	FR191S0051_11		395,00		
	<i>XXS</i>	wall/ceiling	glass XXL grigio	FR191S0051_24	511,00			
			glass XXS bianco	FR191S002_11	371,00			
			glass XXS grigio	FR191S002_24				
		table	glass XXS bianco	FR191S0052_11	275,00			
			glass XXS grigio	FR191S0052_24	361,00			
			lampshade nero	FR111S00_20	741,00			
<i>Mite</i>	floor	lampshade giallo	FR111S00_55	777,00				
		glass bianco		577,00				
<i>Orbital / Bit</i>	floor/wall	glass 1 bianco	FR043S00-1_10	94,00				
		glass 1 rosso	FR043S00-1_63					
		glass 2 bianco	FR043S00-2_10					
		glass 2 blu	FR043S00-2_33					
		glass 3 bianco	FR043S00-3_10					
		glass 4 bianco	FR043S00-4_10					
		glass 4 verde	FR043S00-4_40					
		glass 5 bianco	FR043S00-5_10					
		glass 5 arancio	FR043S00-5_52					
		<i>Plass</i>	<i>grande</i>		suspension	lampshade grigio	FR224S001_25	2.018,00
					table/suspension	lampshade grigio	FR224S002R1_25	452,00
		<i>Rituals</i>	<i>1</i>		table/alta/floor	glass 1	FR244S001B_10	414,00
						table./susp./cel./wall	glass 1	FR244S001_10
wall semi	glass 1 semi			FR244S015_10		259,00		
<i>2</i>	table./susp./cel.		glass 2	FR244S002_10	396,00			
			glass 3	FR244S003_10	299,00			
<i>3</i>	table./susp./cel./wall		glass 3	FR244S003_10	299,00			
			wall semi	glass 3 semi	FR244S035_10	223,00		
<i>XL</i>	table		glass XL	FR244S004_10	580,00			
			table alta/floor	glass XL	FR244S004B_10	591,00		
			suspension	glass XL	FR244S004E_10			
	suspension LED		glass XL	FR244S004_10	580,00			
			wall semi	glass XL semi	FR244S045_10	415,00		
			table	glass external trasparente	FR285V011_15	422,00		
<i>Satellight</i>	table		glass inner bianco	FR285V012_10	118,00			
			suspension	glass external trasparente	FR285V071_15	815,00		
			glass inner bianco	FR285V072_10	168,00			
			disk marrone	FR228S101M_R1	627,00			
<i>Solar Outdoor</i>	floor	lampshade bianco	FR228S11_10	418,00				
		glass bianco	FR273S00E_10	494,00				
<i>Tartan</i>	suspension	glass grigio	FR273S00E_24					
		glass bianco	FR273S00_10	483,00				
		glass grigio	FR273S00_24					
		lampshade 1 nero	FR111S001_20	596,00				
<i>Tress</i>	<i>grande</i>	suspension	lampshade grande susp. bianco	FR182S04_10	841,00			
			lampshade grande susp. greige	FR182S04_25				
			lampshade grande susp. nero	FR182S04_20				
			wall	lampshade grande wall bianco		FR182S005_10	465,00	
			lampshade grande wall nero	FR182S005_20				
			floor/suspension	lampshade media bianco		FR182S02_10	895,00	
	<i>media</i>	floor/suspension	lampshade media greige	FR182S02_25				
			lampshade media nero	FR182S02_20				
			lampshade mini bianco	FR182S0012_10	514,00			
			lampshade mini greige	FR182S0012_25				
			lampshade mini nero	FR182S0012_20				

Spare parts

model	version	description	code	vat excluded			
<i>Tress</i>	<i>piccola</i>	suspension	lampshade piccolo bianco	FR182S01_10	558,00		
			lampshade piccolo greige	FR182S01_25			
			lampshade piccolo nero	FR182S01_20			
			wall	lampshade piccola wall bianco		FR182S0052_10	394,00
			lampshade piccola wall nero	FR182S0052_20			
<i>Tutu</i>	wall	glass bianco	FR114S005_11	155,00			
<i>Twice as Twiggy</i>	floor/suspension	lampshade bianco	CR275RD001_10	1.818,00			
		lampshade nero	CR275RD001_20				
		lampshade greige	CR275RD001_25				
		lampshade cremisi	CR275RD001_67				
<i>Twiggy</i>	floor/susp./cel.	lampshade indaco	CR275RD001_87				
		lower diffusor disk	FR159P05	56,00			
		Floor - until 2020	lampshade bianco	FR159S10_10	806,00		
		lampshade nero	FR159S10_20				
<i>Twiggy</i>	Floor - from 2021	lampshade greige	FR159S10_25				
		lampshade cremisi	FR159S10_67				
		lampshade indaco	FR159S10_87				
		lampshade bianco	FR159D001_10	806,00			
		lampshade nero	FR159D001_20				
		lampshade grafite	FR159D001_22				
		lampshade greige	FR159D001_25				
		lampshade cremisi	FR159D001_67				
lampshade wood	FR159D001_50						
<i>Twiggy Grid</i>	floor/suspension	lampshade grid greige	FR290S00_25		1.165,00		
		lampshade grid carminio	FR290S00_65				

Packing

Size cm
A x B x H

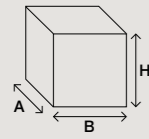

Model	Version	N° boxes	Description	net weight kg	gross weight kg	size cm A x B x H		
Allegretto	<i>Assai</i>	sospensione	1 set rodes	8,7	13,0	91x61x29		
		1 frame	2,6	5,0	47x47x34			
	<i>Ritmico</i>	sospensione	1 set rodes	2,7	4,5	66x41x25		
		1 frame	2,4	4,7	47x47x34			
Vivace	sospensione	1 set rodes	6,4	8,7	84x39x27			
		1 frame	2,7	5,1	47x47x34			
Allegro	<i>Assai</i>	sospensione	1 set rodes	31,0	46,5	187x37x27		
		1 frame	5,0	6,5	43x43x34			
	<i>Ritmico</i>	sospensione	1 set rodes	10,0	11,9	97x53x25		
		1 frame	5,0	6,5	43x43x34			
	<i>Vivace</i>	sospensione	1 set rodes	14,3	16,7	111x44x27		
			1 frame	5,0	6,3	43x43x34		
Anisha	<i>grande</i>	tavolo	1	0,7	1,7	52x38x11		
	<i>piccola</i>	tavolo	1	0,4	1,2	42x30x11		
Aplomb		sospensione	1	1,9	2,9	29x29x51		
		<i>large</i>	sospensione	1 canopy	1,0	1,1	24x24x9	
		1 frame	2,9	4,6	53x53x29			
	<i>mini</i>	sospensione	1	1,9	2,9	36x19x16		
	<i>outdoor</i>	sospensione	1	2,6	3,6	28x28x49		
Bahia		parete	1	1,9	2,8	30x30x52		
		parete/soffitto	1	4,4	5,5	86x81x16		
Big Bang	<i>mini</i>	parete/soffitto	1	2,4	4,7	62x62x18		
		parete/soffitto	1	2,0	3,1	89x31x12		
Big Bang		diffuser set	1	1,0	1,4	23x23x9		
		<i>Halo</i>	sospensione	1	3,4	4,4	89x31x12	
		diffuser set	1	2,0	3,3	89x31x12		
		<i>LED</i>	sospensione	1	3,4	4,4	89x31x12	
	Big Bang L		diffuser set	1	4,0	5,5	89x31x12	
			sospensione	1	13,0	15,0	134x41x9	
1 frame			5,0	6,5	94x39x14			
Big Bang XL		diffuser set	1	2,9	3,3	25x25x14		
		sospensione	1	23,0	30,0	190x46x15		
		1 frame	9,8	11,8	126x53x24			
		1 canopy	2,9	3,3	25x25x14			
Binic		tavolo	1	0,6	1,3	22x22x24		
Birdie	3	soffitto	3 diffuser	0,4	0,8	24x24x27		
			1 canopy	1,0	2,0	24x24x14		
			1 set 3 arms	1,5	5,1	106x59x18		
		6	soffitto	6 diffuser	0,4	0,8	24x24x27	
				1 canopy	1,2	2,0	24x24x14	
				2 set 3 arms	1,5	5,1	106x59x18	
	9	soffitto	9 diffuser	0,4	0,8	24x24x27		
			1 canopy	1,4	2,0	24x24x14		
			3 set 3 arms	1,5	5,1	106x59x18		
	6	sospensione	6 diffuser	0,4	0,8	24x24x27		
			1 canopy	1,2	2,0	20x19x20		
			2 set 3 arms	1,5	5,1	106x59x18		
			9	sospensione	9 diffuser	0,4	0,8	24x24x27
					1 canopy	1,4	2,0	20x19x20
					3 set 3 arms	1,5	5,1	106x59x18
	<i>grande</i>	tavolo	1 diffuser	0,7	1,5	31x31x36		
			1 frame	3,3	5,4	80x30x28		
	<i>piccola</i>	tavolo	1 diffuser	0,4	0,8	24x24x27		
			1 frame	1,6	3,0	27x27x54		
	<i>grande</i>	sospensione	1 diffuser	0,7	1,5	31x31x36		
			1 frame	0,7	1,7	20x20x29		

Packing

Model	Version	N° boxes	Description	net weight kg	gross weight kg	size cm A x B x H
Birdie	<i>piccola</i>	sospensione	1 diffuser	0,4	0,8	24x24x27
		1 frame	0,3	0,6	18x18x26	
		lettura	1 diffuser	0,7	1,5	31x31x36
		1 frame	3,6	7,8	159x29x27	
		parete	1 diffuser	0,4	0,8	24x24x27
		1 frame	1,2	2,5	50x20x29	
Birdie Easy		tavolo	1	1,8	2,8	27x27x54
		lettura	1	4,3	7,4	158x31x32
Birdie Easy grande		tavolo	1	3,5	5,2	32x32x69
Birdie Zero	<i>grande</i>	tavolo	1	1,9	2,9	31x31x36
	<i>piccola</i>	tavolo	1	1,4	2,0	26x26x27
Bit	1	parete	1 glass	1,1	2,3	61x52x11
			1 frame	0,6	1,0	19x19x14
	2	parete	1 glass	0,4	2,3	51x37x11
			1 frame	0,6	1,0	19x19x14
	3	parete	1 glass	1,2	2,3	61x52x11
			1 frame	0,6	1,0	19x19x14
	4	parete	1 glass	0,6	2,3	51x37x11
			1 frame	0,6	1,0	19x19x14
	5	parete	1 glass	0,8	2,3	51x37x11
			1 frame	0,6	1,0	19x19x14
Buds	1	sospensione	1 glass	2,9	3,9	50x50x45
			1 frame	0,7	1,1	31x26x15
	2	sospensione	1 glass	4,2	7,2	50x50x45
			1 frame	0,7	1,1	31x26x15
	3	sospensione	1 glass	2,2	4,4	50x50x45
			1 frame	0,7	1,1	31x26x15
	1 LED	sospensione	1 glass	2,9	3,9	50x50x45
			1 frame	1,3	2,0	29x25x26
	2 LED	sospensione	1 glass	4,2	7,2	50x50x45
			1 frame	1,3	2,0	29x25x26
3 LED	sospensione	1 glass	2,2	4,4	50x50x45	
		1 frame	1,3	2,0	29x25x26	
1	tavolo	1 glass	2,9	3,9	50x50x45	
		1 frame	2,0	2,6	19x19x14	
2	tavolo	1 glass	4,2	7,2	50x50x45	
		1 frame	2,0	2,6	19x19x14	
3	tavolo	1 glass	2,2	4,4	50x50x45	
		1 frame	2,0	2,6	19x19x14	
Bump		sospensione	1	3,0	5,5	61x61x48
Caboche Plus	<i>grande</i>	terra	1 set sphere 1/2	8,3	9,3	38x38x19
			2 set sphere 2/2	3,8	4,3	34x21x19
			1 frame	7,4	12,3	72x72x52
		sospensione	1 stems set	1,3	2,0	154x12x10
			1 set sphere 1/2	8,3	9,3	37x37x17
			1 set sphere 2/2	3,8	4,3	33x19x17
	<i>media</i>	sospensione	1 canopy	0,9	1,1	22x22x7
			1 frame	4,0	7,2	71x71x34
			1 set sphere 1/1	6,2	7,0	38x38x14
		soffitto	1 canopy	0,9	1,1	22x22x7
			1 frame	1,8	3,6	51x51x25
			1 set sphere 1/1	6,2	7,0	38x38x14
<i>media R7s</i>	sospensione	1 frame	2,7	4,5	52x52x28	
		1 set sphere 1/2	6,2	7,0	38x38x14	
<i>media</i>	parete	1 set sphere 2/2	0,5	0,7	21x13x11	
		1 frame	3,8	4,9	52x52x29	
		1 set sphere 1/2	2,8	3,2	34x21x15	
	terra	1 set sphere 2/2	0,3	0,4	20x16x6	
		1 frame	1,2	2,0	48x18x28	
		1 set sphere 1/1	6,2	7,0	38x38x14	
<i>media</i>	sospensione	1 frame	4,3	6,8	52x52x41	
		1 stems set	1,0	1,7	154x12x10	

Packing

Size cm
A x B x H

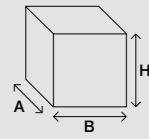

Model	Version	N° boxes	Description	net weight kg	gross weight kg	size cm A x B x H	
Caboche Plus	<i>piccola</i>	sospensione	1	set sphere 1/2	2,8	3,2	34x21x15
			1	set sphere 2/2	0,5	0,7	21x13x11
		1	frame	0,9	1,7	33x33x26	
	tavolo	1	set sphere 1/2	2,8	3,2	34x21x15	
		1	set sphere 2/2	0,5	0,7	21x13x11	
		1	frame	2,1	2,5	28x28x50	
	parete	1	set sphere 1/1	1,9	2,2	35x21x11	
		1	frame	1,1	2,0	19x30x32	
	Chiaroscura	terra	1		4,0	9,2	130x31x31
	Chouchin	1	sospensione	1	glass	3,7	5,4
1			frame	0,7	1,1	31x26x15	
2	sospensione	1	glass	2,2	3,6	35x35x56	
	1	frame	0,7	1,1	31x26x15		
3	sospensione	1	glass	2,9	3,6	39x30x33	
	1	frame	0,7	1,1	31x26x15		
1 LED	soffitto	1		3,4	4,1	39x39x33	
	sospensione	1	glass	3,7	5,4	52x52x45	
2 LED	1	frame	1,3	2,0	29x25x26		
	sospensione	1	glass	2,2	3,6	35x35x56	
3 LED	1	frame	1,3	2,0	29x25x26		
	sospensione	1	glass	2,9	3,6	39x30x33	
1	1	frame	1,3	2,0	29x25x26		
	sospensione	1	glass	2,9	3,6	39x30x33	
Chouchin semi	parete	1	glass	1,5	2,9	39x39x33	
		1	frame	0,5	0,7	18x14x9	
Circus	<i>grande</i>	parete/soffitto	1	glass	3,0	4,4	52x52x17
		1	frame	1,7	2,7	42x42x17	
	<i>piccola</i>	parete/soffitto	1	glass	1,6	2,0	42x42x17
		1	frame	0,5	0,7	19x19x14	
Cri Cri	terra/ tavolo	1		1,0	1,2	23x26x9	
Dolmen	terra	1		11,0	15,3	51x14x214	
	sospensione	1		11,0	15,3	51x14x214	
Double	parete	diffuser	1		1,5	1,9	36x36x23
		1	frame	0,5	0,7	26x16x11	
Fields	1	parete	1		6,0	8,0	178x23x15
		1	diffuser set	1,3	1,5	77x26x4	
	2	1	frame	5,2	7,5	135x26x22	
		1	diffuser set	1,3	1,6	61x33x4	
		1	frame	4,5	6,1	105x26x26	
Filo	tavolo	1		4,2	4,8	71x33x23	
	lettura	1		5,7	8,8	159x34x20	
	parete	1		2,2	3,9	88x32x19	
Folio	<i>grande</i>	parete	1	glass	1,6	3,0	62x52x18
			1	frame	0,6	0,9	56x13x10
		soffitto	1	glass	1,6	3,0	62x52x18
			1	frame	0,6	1,1	57x27x11
	<i>piccola</i>	parete	1	glass	1,0	1,3	38x35x15
			1	frame	0,5	0,8	37x13x10
		tavolo	1	glass	5,4	7,8	51x51x49
Gem	tavolo	1	frame	2,9	4,9	30x28x32	
		1	glass	5,4	7,8	51x51x49	
	tavolo alta	1	glass	5,4	7,8	51x51x49	
		1	frame	1,1	1,6	68x16x15	
	terra	1	base	3,7	4,9	32x32x12	
		1	glass	5,4	7,8	51x51x49	
		1	frame	2,1	3,0	170x16x15	
		1	base	7,7	9,3	47x47x12	

Packing

Model	Version	N° boxes	Description	net weight kg	gross weight kg	size cm A x B x H	
Gem	sospensione	1	glass	5,4	7,8	51x51x49	
		1	frame	0,9	1,3	24x23x18	
	<i>LED</i>	sospensione	1	glass	5,4	7,8	51x51x49
		1	frame	1,3	2,0	29x25x26	
	<i>semi</i>	soffitto	1		5,9	8,3	51x51x49
		parete	1	glass	2,7	4,4	57x49x47
Gioia		1	frame	0,5	0,7	18x14x9	
		1		2,2	3,0	44x47x8	
Gregg	<i>grande</i>	sospensione	1	glass	5,0	7,0	57x49x47
		1	frame	0,9	1,3	24x23x18	
	tavolo	1	glass	5,0	7,0	57x49x47	
		1	frame	1,8	2,5	23x23x18	
	tavolo alta	1	base	5,0	7,0	57x49x47	
		1	glass	1,1	1,6	68x16x15	
		1	frame	3,7	4,9	32x32x12	
		1	base	5,0	7,0	57x49x47	
		1	montatura	2,1	3,0	170x16x15	
		1	base	7,7	9,3	47x47x12	
	<i>grande semi</i>	soffitto	1		5,5	7,5	61x521x45
		parete	1	glass	2,5	4,2	57x49x47
<i>grande LED</i>	sospensione	1	frame	0,5	0,7	18x14x9	
		1	glass	5,0	7,0	57x49x47	
<i>media</i>	sospensione	1	glass	2,5	2,8	39x34x31	
		1	frame	0,7	1,1	31x26x15	
	tavolo	1	glass	2,5	2,8	39x34x31	
		1	frame	0,8	1,2	19x19x18	
	tavolo alta	1	glass	2,5	2,8	39x34x31	
		1	frame	1,1	1,6	68x16x15	
	terra	1	base	3,7	4,9	32x32x12	
		1	glass	2,5	2,8	39x34x31	
		1	frame	1,9	2,7	145x14x14	
		1	base	3,7	4,9	33x33x10	
<i>media</i>	parete/soffitto	1	glass	2,5	2,8	39x34x31	
		1	frame	0,4	0,7	19x19x18	
<i>media semi</i>	parete	1	glass	1,3	2,7	51x51x37	
		1	frame	0,5	0,7	18x14x9	
MEDIA LED	sospensione	1	glass	2,5	2,8	39x34x31	
		1	frame	1,3	2,0	29x25x26	
MIDI	tavolo	1		1,4	1,9	25x24x25	
		1	sospensione	1,4	1,9	25x24x25	
	parete/soffitto	1		1,4	1,9	25x24x25	
		1	parete/soffitto	0,6	0,9	19x20x20	
<i>piccola</i>	sospensione	1		0,7	0,9	19x20x20	
	tavolo	1		0,6	0,9	19x20x20	
Gregg outdoor	<i>grande</i>	sospensione	1	diffuser	2,3	3,5	51x43x40
		1	frame	0,7	1,5	22x18x27	
	terra	1	diffuser	2,3	3,5	51x43x40	
		1	frame	1,3	2,3	29x29x16	
	<i>media</i>	sospensione	1	diffuser	0,7	1,4	34x29x27
		1	frame	0,7	1,5	22x18x27	
	terra	1	diffuser	0,7	1,4	34x29x27	
		1	frame	0,9	1,7	22x22x16	
<i>XL</i>	sospensione	1	diffuser	3,0	5,4	64x54x51	
		1	frame	0,7	1,5	22x18x27	
	terra	1	diffuser	3,0	5,4	64x54x51	
		1	frame	1,3	2,3	29x29x16	
Havana outdoor	sospensione	1	diffuser	2,0	3,3	26x26x133	
		1	frame	1,0	1,4	65x14x11	
	<i>base</i>	terra	1	diffuser	2,0	3,3	26x26x133
			1	base	6,1	6,5	37x37x4
1	frame	2,0	2,9	107x15x15			

Packing

Size cm
A x B x H

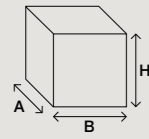

Model	Version	N° boxes	Description	net weight kg	gross weight kg	size cm A x B x H	
<i>Havana outdoor</i>	<i>cilindro</i>	1	diffuser	2,0	3,3	26x26x133	
		1	underground base	0,5	0,7	15x15x24	
		1	frame	3,0	4,0	107x15x15	
	<i>picchetto</i>	terra	1	diffuser	2,0	3,3	26x26x133
			1	stake mounted	1,2	1,5	15x14x47
			1	frame	2,0	2,5	107x15x15
	<i>bassa base</i>	terra	1	diffuser	2,0	3,3	26x26x133
			1	base	6,1	6,5	37x37x4
			1	frame	2,0	2,9	107x15x15
	<i>bassa cilindro</i>	terra	1	diffuser	2,0	3,3	26x26x133
			1	underground base	0,5	0,7	15x15x24
			1	frame	3,0	3,8	107x15x15
<i>bassa picchetto</i>	terra	1	diffuser	2,0	3,3	26x26x133	
		1	stake mounted	1,2	1,5	15x14x47	
		1	frame	1,5	2,4	107x15x15	
<i>Havana</i>	sospensione/parete	1	diffuser set	1,3	1,8	50x25x25	
		1	frame	0,6	0,8	19x19x14	
	terra	1	diffuser set	1,3	1,8	50x25x25	
		1	frame	2,0	3,0	100x30x14	
<i>Kurage</i>	tavolo	1		0,7	3,5	40x40x66	
<i>Lake</i>	parete	1	diffuser	1,3	2,5	58x50x12	
		1	frame	0,4	0,7	18x18x17	
<i>Le Soleil</i>	parete	1	diffuser set	0,8	1,5	39x32x13	
		1	frame	0,5	0,9	30x22x12	
	sospensione	1	diffuser set	4,1	6,0	62x62x24	
		1	frame	1,2	2,5	26x26x34	
<i>Lightweight</i>	sospensione	1		7,6	21,6	112x112x82	
<i>Lumiere</i>	<i>grande</i>	tavolo	1	glass	1,4	2,2	35x35x27
		1	frame	0,7	1,6	52x26x27	
	<i>piccola</i>	tavolo	1	glass	0,9	1,7	29x29x24
		1	frame	0,5	1,0	43x20x23	
<i>Lumiere Naunces</i>	<i>grande</i>	tavolo	1		2,1	5,3	86x37x29
	<i>piccola</i>	tavolo	1		1,4	3,3	70x29x25
<i>Lumiere XXL</i>	parete/soffitto	1	glass	1,8	4,1	42x42x21	
		1	frame	1,2	2,4	42x42x14	
	tavolo	1	glass	4,0	6,2	51x51x37	
		1	frame	1,5	2,8	39x39x62	
	lettura	1	glass	4,0	6,2	51x51x37	
		1	frame	12,5	13,5	156x43x15	
<i>Lumiere XXS</i>	parete/soffitto	1	glass	1,0	1,6	32x32x18	
		1	frame	0,8	1,4	31x31x11	
	tavolo	1	glass	1,2	2,3	33x33x27	
		1	frame	0,6	1,7	44x28x28	
<i>Madre</i>	tavolo	1		4,9	8,0	57x43x50	
<i>Magneto</i>	lettura	1		2,8	5,0	131x25x6	
		1		1,3	1,8	42x25x8	
<i>Mite</i>	terra	1		7,0	11,1	197x28x28	
<i>Nile</i>	tavolo	1	glass	2,0	3,5	31x28x52	
		1	frame	8,0	8,5	19x19x31	
<i>Nuée</i>	sospensione	1		6,4	9,0	103x39x25	
<i>Orbital</i>	terra	1	glass set	4,1	5,5	72x52x12	
		1	frame	6,0	9,7	185x32x27	
		1		5,0	10,0	130x32x32	
<i>Plass</i>	<i>grande</i>	sospensione	1	diffuser	18,0	24,0	120x80x80
		1	frame	5,0	10,0	130x32x32	
		sospensione	1	diffuser	2,8	3,6	36x36x52
		1	frame	0,7	1,2	47x22x14	

Packing

Model	Version	N° boxes	Description	net weight kg	gross weight kg	size cm A x B x H		
<i>Plass</i>	<i>media</i>	tavolo	1	diffuser	2,8	3,6	36x36x52	
		1	frame	1,2	2,0	22x22x32		
<i>Polygregg</i>	<i>grande</i>	tavolo	1	diffuser	2,3	3,5	51x43x40	
		1	frame	1,3	2,3	29x29x16		
		1	diffuser	0,7	1,4	34x29x27		
	<i>media</i>	tavolo	1	frame	0,9	1,7	22x22x16	
			1	diffuser	3,0	5,4	64x54x51	
			1	frame	1,3	2,3	29x29x16	
<i>Rituals</i>	1	parete	1	glass	2,5	3,0	34x34x41	
			1	frame	1,4	2,0	28x19x18	
				soffitto	1	3,0	3,5	34x34x41
	1	sospensione	1	glass	2,5	3,0	34x34x41	
			1	frame	0,5	0,8	19x19x14	
				tavolo	1	2,5	3,0	34x34x41
				1	frame	0,6	1,2	27x26x19
				tavolo alta	1	2,5	3,0	34x34x41
				1	frame	1,1	1,6	68x16x15
				1	base	3,7	4,9	32x32x12
				terra	1	2,5	3,0	34x34x41
				1	frame	1,9	2,7	145x14x14
			1	base	3,7	4,9	33x33x10	
	1 semi	parete	1	glass	1,7	3,1	52x37x27	
			1	frame	0,5	0,7	18x14x9	
	2	soffitto/parete	1		4,0	4,5	42x42x27	
1			glass	3,0	3,4	42x42x27		
			1	frame	0,5	0,8	19x19x14	
			tavolo	1	3,0	3,4	42x42x27	
			1	frame	0,6	1,2	27x26x19	
	3	parete	1	glass	1,0	1,6	26x26x27	
1			frame	1,4	2,0	28x19x18		
			soffitto	1	1,5	2,1	26x26x30	
			sospensione	1	1,0	1,6	26x26x27	
			1	frame	0,5	0,8	19x19x14	
			tavolo	1	1,0	1,6	26x26x27	
			1	frame	0,6	1,2	27x26x19	
	3 semi	parete	1	glass	2,5	3,0	30x30x22	
1			frame	0,5	0,7	18x14x9		
	XL	tavolo alta	1	glass	5,9	8,0	51x51x49	
1			frame	1,1	1,6	68x16x15		
			1	base	3,7	4,9	32x32x12	
			terra	1	5,9	8,0	51x51x49	
			1	frame	2,1	3,0	170x16x15	
			1	base	7,7	9,3	47x47x12	
			tavolo	1	5,9	8,0	51x51x49	
			1	frame	1,2	2,0	22x22x32	
			sospensione	1	5,9	8,0	51x51x49	
			1	frame	0,9	1,3	24x23x18	
			soffitto	1	6,4	8,5	51x51x49	
	XL semi	parete	1	glass	2,7	4,4	57x49x47	
1			frame	0,5	0,7	18x14x9		
	XL LED	sospensione	1	diffuser	5,9	8,0	51x51x49	
1			frame	1,3	2,0	29x25x26		
<i>Satellite</i>	tavolo	1		3,0	3,7	35x35x26		
		sospensione	1		5,5	6,3	49x49x53	
		1		1,4	2,2	29x29x38		
<i>Solar outdoor</i>	terra	1	diffuser	9,4	13,7	88x88x28		
		1	frame	2,3	3,6	32x32x18		
<i>Spokes</i>	1	sospensione	1	canopy	1,0	1,1	24x24x9	
			1	structure	4,0	6,0	41x41x80	
	2	sospensione	1	canopy	1,0	1,1	24x24x9	
			1	structure	4,0	6,5	61x61x62	
	2 large	sospensione	1	canopy	1,0	1,1	24x24x9	
			1	structure	5,0	11,0	78x78x84	

Packing

Size cm
A x B x H

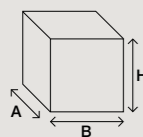

Model	Version	N° boxes	Description	net weight kg	gross weight kg	size cm A x B x H
<i>Spokes</i>	<i>2 midi</i>	sospensione	1 canopy	1,0	1,1	24x24x9
		1 frame	3,6	5,1	51x51x62	
	<i>2 piccola</i>	sospensione	1 rosone	1,0	1,1	24x24x9
		1 corpo luce	3,6	5,1	51x51x62	
	<i>3</i>	sospensione	1 canopy	1,0	1,1	24x24x9
		1 frame	3,9	5,8	70x70x52	
<i>Sun-Light of Love</i>	sospensione	2 diffusor set	5,1	6,8	52x37x18	
	1 frame	2,0	2,5	24x24x22		
	1 canopy	1,0	1,5	24x24x9		
<i>Supernova</i>	sospensione	1	8,0	10,6	82x72x17	
<i>Tartan</i>	sospensione	1 diffusor	4,0	6,5	50x50x45	
	1 frame	0,9	1,3	24x23x18		
	soffitto	1	4,5	7,0	50x50x45	
<i>LED</i>	sospensione	1 diffusor	4,0	6,5	50x50x45	
	1 frame	1,3	2,0	29x25x26		
<i>Tite</i>	<i>1</i>	sospensione	1 diffusor	0,8	2,0	124x30x30
		1 frame	0,6	1,2	80x16x14	
	<i>2</i>	sospensione	1 diffusor	0,5	1,3	65x28x28
		1 frame	0,5	1,1	45x16x14	
<i>Tobia</i>	parete con cavo	1	1,5	2,4	48x20x23	
	parete	1	1,7	2,6	48x20x23	
	terra	1	3,7	6,2	183x45x37	
<i>Tress</i>	<i>grande</i>	parete	1 diffusor	0,4	1,6	69x33x20
		1 frame	0,7	0,9	37x13x10	
	<i>grande R7s</i>	sospensione	1 diffusor	1,1	2,9	52x52x45
		1 frame	3,8	4,9	47x47x24	
	<i>grande LED</i>	sospensione	1 diffusor	1,1	2,9	52x52x45
		1 frame	0,9	1,1	24x24x9	
	<i>grande LED</i>	terra	1 frame+diffuser	5,0	8,5	201x31x35
		1 base	5,5	6,0	27x27x4	
	<i>grande R7s+E27</i>	terra	1 frame+diffuser	3,0	7,0	201x31x35
		1 base	5,5	6,0	27x27x4	
	<i>media</i>	sospensione	1 diffusor	1,6	3,5	119x31x31
		1 frame	0,8	1,0	22x22x16	
terra		1 diffusor	1,6	3,5	119x31x31	
<i>piccola</i>	parete	1 frame	2,3	2,5	29x29x16	
		1 diffusor	0,3	1,5	49x33x20	
	sospensione	1 frame	0,8	1,0	37x13x10	
<i>mini</i>	sospensione	1 diffusor	0,9	1,8	62x62x24	
		1 frame	0,8	1,0	22x22x16	
	1 diffusor	0,4	1,4	53x27x27		
<i>Troag</i>	<i>media</i>	sospensione	1	0,7	19x19x14	
<i>Tuareg</i>	terra	1 structure	2,8	4,2	90x90x25	
		1 base	6,4	8,8	157x25x18	
<i>Tutù</i>	parete	1 glass	0,5	1,2	38x19x24	
		1 frame	0,3	0,7	37x13x10	
<i>Twice as Twiggy</i>	sospensione	1 diffusor	5,4	12,7	87x86x56	
		1 canopy	3,0	3,5	27x27x19	
	terra	1 diffusor	5,4	12,7	87x86x56	
		1 stem	5,0	8,1	204x27x16	
	1 base	7,0	13,7	70x70x6		
	1 ballast	29,5	37,5	70x70x7		
	1 ballast base	24,4	29,0	70x70x7		
1 assembling tool	3,0	4,4	38x18x103			

Packing

Model	Version	N° boxes	Description	net weight kg	gross weight kg	size cm A x B x H
<i>Twiggy</i>	sospensione	1 diffusor	1,6	1,8	52x52x33	
		1 frame	0,8	1,1	56x16x16	
	lettura	1 diffusor	1,0	2,9	52x52x33	
		1 frame	1,5	3,0	165x22x23	
		1 base	8,3	8,7	56x56x7	
		soffitto	1 diffusor	1,6	1,8	52x52x33
		1 frame	4,0	6,0	194x30x18	
		terra	1 diffusor	1,6	1,8	52x52x33
		1 frame	1,5	3,9	188x22x23	
		1 base	13,5	15,3	70x70x7	
	1 stem set	0,1	0,4	52x52x5		
	<i>LED</i>	terra	1 diffusor	1,6	3,5	52x52x33
1 frame		2,0	3,0	172x20x13		
	1 base	13,5	15,3	70x70x7		
	<i>Twiggy Elle</i>	terra	1 diffusor	1,6	3,5	52x52x33
1 frame		2,3	3,4	222x20x13		
1 base		13,5	15,3	70x70x7		
<i>Twiggy Grid</i>	sospensione	1 diffusor	1,6	2,8	52x52x33	
		1 frame	1,2	2,0	40x39x17	
	terra	1 diffusor	1,6	2,8	52x52x33	
		1 frame	2,1	5,9	197x39x14	
	1 base	13,5	15,3	70x70x7		
	lettura	1 diffusor	1,6	2,8	52x52x33	
1 frame		23,6	26,0	187x37x27		
XL	1 diffusor	1,6	2,8	52x52x33		
	1 frame	23,6	26,0	72x46x44		
<i>Uptown</i>	* <i>cassa legno</i>	1	22,0	56,0	211x38x47	
<i>Uto</i>		1	2,0	3,4	80x30x22	
Accessori						
<i>Rosone multiplo</i>	<i>tondo</i>	1	9,0	10,7	63x63x11	
		1	6,8	7,7	102x29x11	
		1	10,0	11,5	147x29x11	
<i>Kit avvolgicavo outdoor</i>		1	0,2	0,4	52x5x5	

Legenda



LED

It marks the models with integrated LED included in the lamp, which is the result of Foscarini designing and engineering.



Classe I

Class I° luminaire: it's necessary to connect the device to the yellow/green protective conductor (earthing).



Dimmer

Please verify the compatibility of your bulb with the dimmer's wattage ranges, indicated on the dimmer itself, according to the kind of light source.



CSQ - IQNET

The CSQ-IQNET label is valid all over the world. It certifies that Foscarini runs a quality management system which complies with the UNI EN ISO 9001:2008 standard, to guarantee a high quality level for what concerns project, development, production and distribution of its products.



CE

Declares that the manufacturer produces light fittings which comply with the requirements of the EN 60598.



Classe II

Light fittings whose safety is guaranteed only by the double and/or reinforced insulation of all parts, with no earth.



IP Protection Degree

IP20: protected against the penetration of solid objects greater than 12 mm and non protected against liquids.
IP44: protected against the penetration of solid objects greater than 1 mm and protected against splashing water.
IP65: dust-tight and protected against water jets.



CSQ ECO

This label is valid all over the world. It certifies that Foscarini runs an environmental management system which complies with the UNI EN ISO 14001:2004 standard in order to guarantee company's commitment to continual improvement of its environmental performances.



ENEC

The label ENEC (Electrical Certification concerning European Standard) is a voluntary label granted by third organizations. It certifies that a product complies with the EN 60598 standards and has been designed and manufactured by companies with an approved UNI EN ISO 9001 quality control system.



Classe III

Appliance in which protection against electrical shock is guaranteed by the extremely low-voltage power supply and which does not produce higher voltages.

Azienda certificata
UNI EN ISO 9001:2015
UNI EN ISO 14001:2015



General terms and conditions of sale

The general terms and conditions herein apply to all contracts for the sale of goods entered into between FOSCARINI SPA (hereinafter referred to as "Foscarini") and the customer (hereinafter, the "Customer") and form an integral part of the contractual agreement entered into with the acceptance of the order. Any changes to the above must be made by written agreement duly signed by both parties.

If the Customer is a consumer, the provisions of the general terms and conditions of sale herein do not jeopardise the rights the same is entitled to in accordance with the legal provisions regarding sales made to consumers.

→ 1 Orders

To enter into the sales contract, the electronic form needs to be filled in on the Foscarini portal, www.myfoscarini.com. The contract is entered into upon acceptance of the order by Foscarini. The contract is governed by the Order as set out herein above and by the general terms and conditions herein.

→ 2 Products - Changes

2.1 The representations and/or pictures of the products shown on websites, in brochures, catalogues, price lists or similar documents have an indicative and illustrative value. Consequently, they do not represent the final styling result of the products. The technical and physical characteristics of the same are only provided in Foscarini's technical manuals, with the specification that the dimensions and colours indicated therein may have an unavoidable tolerance due to the characteristic craft-based processing of blown glass.

2.2 Foscarini declares that the Products conform to the applicable industry standards. Under penalty of ineffectiveness of the guarantee referred to in article 6 and any other conventional and/or legal guarantee, each Product shall be used and installed in conformity with Foscarini's usage instructions referred to the products in question and provided in Foscarini's instructions and/or technical manuals or otherwise notified or made accessible by Foscarini to the Customer and, in any case, in conformity with the diligence required by the nature of the products themselves.

2.3 It is the Customer's responsibility, prior to entering into the Sales Contract, to ascertain that the products are fit for the purpose and/or specific use for which (s)he intends to purchase them and, furthermore, to ascertain that they conform to the applicable regulations in the place in which the Customer intends to import them, distribute them, sell them or make use of them.

2.4 Foscarini, even after the Sales Contract has been entered into, may make any changes to the products it deems necessary or appropriate, provided these do not alter their essential characteristics, providing written notification thereof to the Customer.

2.5 The Customer will be obliged to represent to the product purchasers and to third parties the characteristics of the products as well as the instructions for use and application of the same, in conformity with the representation provided in turn by Foscarini. Without prejudice to the above, the Customer shall be solely responsible for the declarations made to third parties in regard to the Products, to their characteristics and to

their use and/or installation and shall indemnify and release Foscarini from liability for any damage incurred by Foscarini in relation to or in connection with such declarations, should these be false, incomplete and/or inaccurate.

→ 3 Delivery

The delivery time frames specified in the order are purely indicative and non-binding. The goods travel carriage paid (INCOTERMS DAP 2010), except where otherwise agreed by the Parties in the Order.

→ 4 Prices, payment, delayed payment

4.1 The Products shall be supplied at the prices specified in the order or at the prices indicated in Foscarini's price list in force at the time the Sales Contract is entered into. Unless otherwise specified in writing, the prices of the Products indicated in Foscarini price lists, quotes and/or offers are understood to be recommended retail prices, expressed in Euro, VAT not included.

4.2 Payment for the Products shall be made by the Customer using the methods and within the time frames specified on the invoice or otherwise agreed upon in writing by the parties. Payments shall be considered as having been made by the Customer only at the time in which the related amount has been credited into Foscarini's current account.

4.3 Should the Customer be delayed in making payment, Foscarini shall be entitled:

a) to payment of the statutory interest on arrears, in conformity with the applicable law;
b) to suspend pending deliveries, prior to written notification to the Customer, until the amounts due and the related interest on

arrears have been paid in full.
4.4 Should these amounts and interests still remain unpaid after 30 (thirty) days from the agreed payment due date, Foscarini may also, at its sole discretion, alternatively or cumulatively, and in addition to any other right or remedy it is entitled to by law or by the General terms and conditions herein:

a) demand immediate payment of any outstanding debt, even if payment in instalments or deferred payment has been agreed and/or drafts or bills of exchange, promissory notes, cheques or other means of payment have been issued and are due;
b) terminate the Sales Contract in question and permanently withhold any amounts already received which will be charged as a penalty unless the damage that Foscarini reserves the right to quantify is greater;
c) carry out future product deliveries only upon advance payment ahead of outstanding supplies yet to be made;
d) revoke discounts and bonuses that have been agreed by the parties.

4.5 The rights referred to in previous paragraphs 4.3 and 4.4 may be exercised at any time by Foscarini also in the event that: a) the Customer undergoes liquidation, is put into administration, is undergoing bankruptcy proceedings, debt restructuring or enforcement actions; or b) the Customer is in a state of financial difficulty - fit to determine a prejudice to the prompt fulfilment of his/her payment obligations - resulting, by way of example but in no way limited to, from the removal of objections, the reduction in guarantees granted and/or the failed provision of guarantees promised, and the occurrence of any unpaid amounts.

4.6 The Customer may not enforce any non-fulfilments on the

General terms and conditions of sale

part of Foscarini nor may (s)he take any legal action against the same until (s)he has paid Foscarini in full all amounts the latter is entitled to pursuant to the provisions of paragraphs 4.3 and 4.4.

→ 5

Reservation of ownership

5.1 Foscarini shall retain ownership of the Products sold until their price has been paid in full by the Customer.

5.2 In the event of non-fulfilment or delay in fulfilling the obligation to pay the price of the Products, without prejudice to the provisions of previous paragraphs 4.4, 4.5 and 4.6, Foscarini shall be entitled to access the premises where the products are held, to resume ownership of the same and to confiscate definitively, as a penalty, any amounts paid by the Customer for the products in question.

→ 6

Guarantee

6.1 Without prejudice to the provisions of the previous paragraphs 2.1, 2.2, 2.4 and in regard to the product changes permitted and the tolerances, Foscarini guarantees the Customer that the products will conform to the Sales Contract, to the classification indicated in Foscarini's technical manuals and that they are free from manufacturing defects. The guarantee herein will be valid for 12 (twelve) months from the date of delivery of the products.

6.2 The following are excluded from any guarantee:

a) chromatic alterations and differences in shade of the products;
b) products classified in the Sales Contract as of lower quality than first choice or product batches at the end of a

series sold in block as special batches;
c) products that are not assembled and/or installed in a professional manner and/or laid in a way that differs from the provisions of the applicable industry regulations and the instructions enclosed with the same;

d) products installed on surfaces and/or in settings other than those recommended by Foscarini;
e) Products used in a way that differs from the instructions and/or indications provided by Foscarini included in Foscarini's technical manuals or instructions or notified to the Customer by Foscarini in another way, including the provisions specified in the previous paragraph 2.2;
f) products used in a way that does not conform to due diligence and/or the technique required by the nature of the products themselves;

6.3 The Customer shall be obliged to examine the products as quickly as possible and, on pain of forfeiture of the guarantee herein, to report in writing to Foscarini, by e-mail:
a) non-conformities relating to the type and/or quantity of products received as well as other clearly apparent non-conformities in the products or evident defects: by no later than 8 (eight) days from delivery of the products and, in any case, before they are installed;
b) hidden non-conformities or hidden defects in the products: by no later than 8 (eight) days from their discovery and, in any case, within the guarantee period.

6.4 Foscarini shall be entitled to check the products, or certain samples of the products, that the Customer deems to be non-conforming or defective, also in order to verify the respect of the instructions relating to the installation of the same and/or the installation and/or use as

specified in the General terms and conditions of sale herein. To this end, the Customer may return to Foscarini the products deemed by the same as being non-conforming or defective only subject to the written authorisation of Foscarini. The authorisation to return the products or the samples ascertained as being non-conforming or defective will under no circumstances constitute the acknowledgement of the non-conformities or defects on the part of Foscarini.

6.5 In the event that the Products are acknowledged by Foscarini as being effectively non-conforming or defective, the Customer, at Foscarini's choice, shall be solely entitled:
a) to the free replacement of non-conforming or defective Products; or
b) to the partial or total exemption from payment of their price, depending on how serious the non-conformities or defects are.

6.6 The products that have been replaced shall be, at Foscarini's choice, destroyed or disposed of by the Customer, at the expense of the latter, or returned to Foscarini, at Foscarini's expense.

6.7 The rights and remedies described in the previous paragraphs 6.5 and 6.6 constitute the sole rights and remedies granted under guarantee. To the maximum extent permitted by law, further liabilities or obligations on the part of Foscarini are excluded in relation to the supply of non-conforming or defective products, including, by way of example but in no way limited to, liabilities and obligations for any direct, indirect or consequential damages, loss of profit, etc. to which such a liability is connected.

6.8 The guarantee herein replaces and excludes all other guarantees, whether express

or implicit, envisaged by law or otherwise.
6.9 In the event that the Customer is a consumer, the legal guarantee envisaged by the consumer code shall apply.

→ 7

Applicable Law - Settlement of disputes
The general terms and conditions of sale herein and the contracts entered into between Foscarini and the Customer shall be governed and regulated by Italian law. The Court of Venice shall have jurisdiction over any disputes.

Colophon

Foscarini SpA
via delle Industrie 27
30020 Marcon / Venezia / Italy
T +39 041 595 3811
foscarini@foscarini.com

Foscarini Spazio Monforte
Corso Monforte 19
20122 / Milano / Italy
T +39 02 870 71320
spaziomonforte@foscarini.com

Foscarini Inc / Foscarini Spazio Soho
20 Greene Street, New York
NY / 10013 / USA
T +1 212 247 2218
T +1 212 257 4412 | Showroom
foscarini.inc@foscarini.com
spaziosoho@foscarini.com

Foscarini Japan K.K.
Tokyo / Japan
foscarini.jpn@foscarini.com

Foscarini International Co., Ltd.
Shanghai, China
foscarini.china@foscarini.com

Azienda certificata
UNI EN ISO 9001
UNI EN ISO 14001



edition 12.2022

Concept and graphic design:
Designwork
art direction: Artemio Croatto
art work: Erika Pittis

Photography:
Massimo Gardone / Azimut
Gianluca Vassallo

Printed in Italy
Grafiche GFP

Follow us:



foscarini.com



FOSCARINI