

# LODES

Pag.	Product name
	Suspension lamps:
003	Cima
004	Elara
005	IVY V
007	JIM dome
008	Sky-Fall
011	Kelly dome
012	Kelly sphere
013	Volum
	Cluster suspension lamps:
015	A-Tube
017	A-Tube Nano
021	A-Tube Nano Duo
022	IVY I
023	Jefferson
024	JIM
026	Kelly Cluster
027	Nostalgia
030	Rain
032	Random
033	Random Solo
038	Spider
039	Volum
	Canopies:
041	Single Systems
043	Multiple Systems
	Wall & Ceiling lamps:
051	A-Tube
052	Aile
052	Bugia
054	Kelly
055	Laser
056	Make-Up
057	Nautilus
057	Nautilus Mini
058	Nautilus Spot
059	Pin-Up
060	Puzzle
061	Puzzle Mega
064	Puzzle Round
065	Spider
065	Tidal
066	Volum
	Floor & Table lamps:
072	Blow
069	Cima
070	Croma
071	Flar
074	Hover
073	Easy Peasy
075	Volum
	Outdoor lamp:
076	Puzzle Outdoor
078	Accessories



# Suspension lamps

## Suspension lamps

---

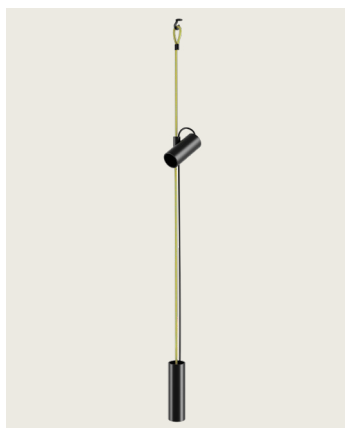

Cima  
Pag. 003

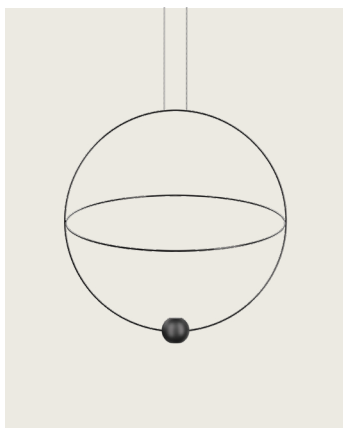

Elera  
Pag. 004

NEW LAMP



IVY V  
Pag. 005, 006

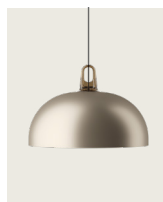

JIM  
Pag. 007



Sky-Fall  
Pag. 008-010



Kelly dome  
Pag. 011

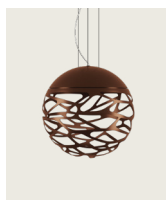

Kelly sphere  
Pag. 012



Volum  
Pag. 013

# Cima, design by Marco Dessí, 2021

Suspension lamp

Floor lamp

## Cima

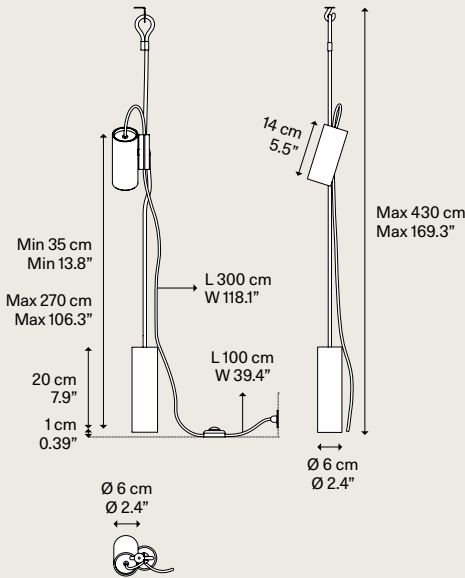

Light source Sorgente luminosa	Metal structure Montatura in metallo	Rope Corda	Code Codice	Iva esclusa Vat excluded Euro €
GU10 Par 16 LED ≈ 1 × 10 W	● Matte Black Nero Opaco	Silver Argento	17371 4100	285,00
W/L max 9 cm W/L max 3.54"		Gold Oro	17371 5000	285,00
		Yellow Giallo	17371 5100	285,00
Bulb and dimmer not included Lampadina e dimmer non inclusi				

Light source Sorgente luminosa	Description Descrizione	Metal structure Montatura in metallo	Code Codice	Iva esclusa Vat excluded Euro €
GU10 Par 16 LED ≈ 1 × 10 W	Additional kit max 2 spotlights	● Matte Black Nero Opaco	17371K2000	195,00
W/L max 9 cm W/L max 3.54"	Kit aggiuntivo max 2 spotlights			
Bulb and dimmer not included Lampadina e dimmer non inclusi				

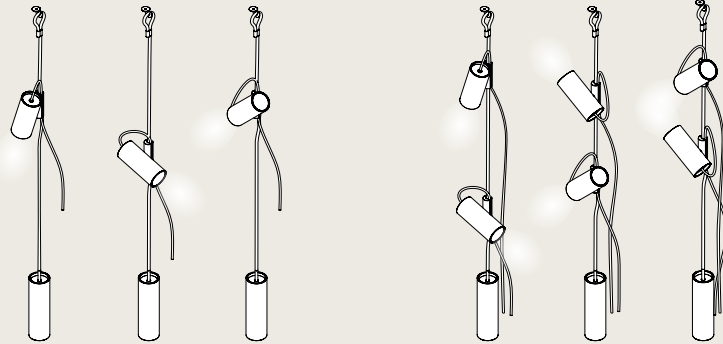

Adjustable light  
Luce orientabile

Net weight/Peso netto: 1.750 kg

Pack/Colli: 1



Suspension lamp

Cluster suspension lamp

Canopy

Wall & Ceiling lamp

Floor & Table lamp

Outdoor lamp

Accessory

# Elara, design by Nika Zupanc, 2022

Suspension lamp

## Elara medium **NEW**

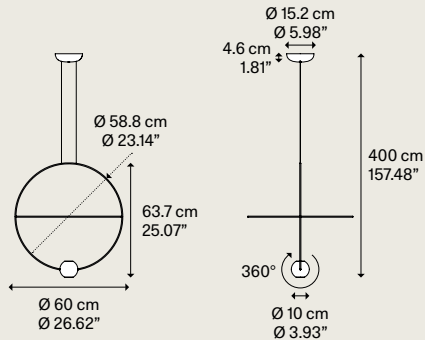

### Light source Sorgente luminosa

LED  
 ▸ 2700 K  
 ▸ 27 W  
 Side I 2100 lm  
 Side II 800 lm  
 ▸ 1000 mA  
 ▸ CRI 90  
 ▸ MacAdam 3-Step

or

LED  
 ▸ 3000 K  
 ▸ 27 W  
 Side I 2260 lm  
 Side II 845 lm  
 ▸ 1000 mA  
 ▸ CRI 90  
 ▸ MacAdam 3-Step

LED and driver included  
 LED e driver inclusi

### Metal structure Montatura in metallo

● Glossy Black  
Nero Lucido

● Glossy Gold  
Oro Lucido

● Glossy Black  
Nero Lucido

● Glossy Gold  
Oro Lucido

### Metal sphere Sfera in metallo

● Extra Matte Black  
Nero Extra Opaco

● Matte Gold  
Oro Opaco

● Extra Matte Black  
Nero Extra Opaco

● Matte Gold  
Oro Opaco

### Code Codice

20621 2227

20621 5027

20621 2230

20621 5030

Iva esclusa  
 Vat excluded  
**Euro €**

650,00

780,00

650,00

780,00

Net weight/Peso netto: 1.9 kg

Pack/Colli: 1

Energy class/Classe energetica: 2700 K ▶ D+E - 3000 K ▶ D+F

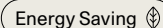
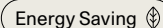
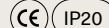

## Elara large **NEW**

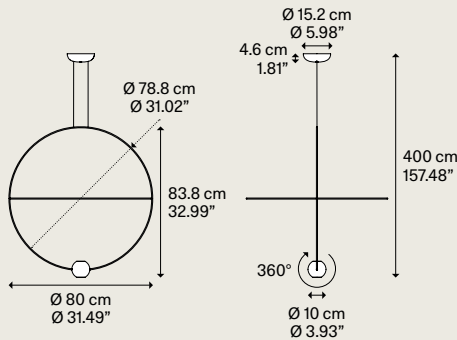

### Light source Sorgente luminosa

LED  
 ▸ 2700 K  
 ▸ 27 W  
 Side I 2100 lm  
 Side II 800 lm  
 ▸ 1000 mA  
 ▸ CRI 90  
 ▸ MacAdam 3-Step

or

LED  
 ▸ 3000 K  
 ▸ 27 W  
 Side I 2260 lm  
 Side II 845 lm  
 ▸ 1000 mA  
 ▸ CRI 90  
 ▸ MacAdam 3-Step

LED and driver included  
 LED e driver inclusi

### Metal structure Montatura in metallo

● Glossy Black  
Nero Lucido

● Glossy Gold  
Oro Lucido

● Glossy Black  
Nero Lucido

● Glossy Gold  
Oro Lucido

### Metal sphere Sfera in metallo

● Extra Matte Black  
Nero Extra Opaco

● Matte Gold  
Oro Opaco

● Extra Matte Black  
Nero Extra Opaco

● Matte Gold  
Oro Opaco

### Code Codice

20622 2227

20622 5027

20622 2230

20622 5030

Iva esclusa  
 Vat excluded  
**Euro €**

790,00

950,00

790,00

950,00

Net weight/Peso netto: 2 kg

Pack/Colli: 1

Energy class/Classe energetica: 2700 K ▶ D+E - 3000 K ▶ D+F

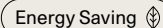
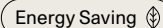
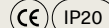

### Adjustable light Luce orientabile

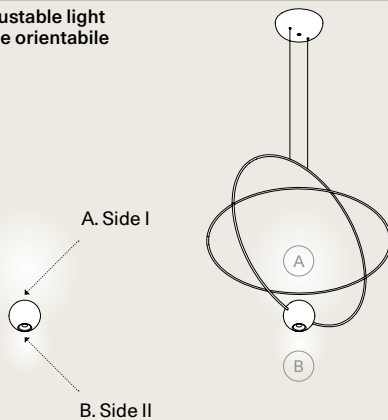

### Adjustable ring Anello orientabile

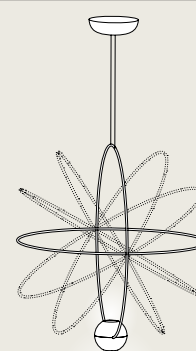

Ecodesign regulation ▶ pag. 084-085  
 Regolamento di Ecodesign ▶ pag. 084-085

# IVY V, design by Vittorio Massimo, 2022

Central cluster suspension lamp

## IVY V

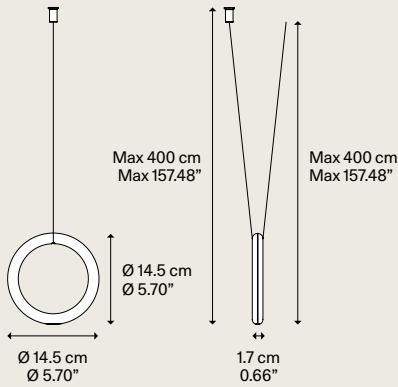

### Light source Sorgente luminosa

LED  
 ↘ 2700 K  
 ↘ 3 W / 450 lm  
 ↘ 350 mA  
 ↘ CRI 90  
 ↘ MacAdam 3-Step

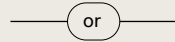

LED  
 ↘ 3000 K  
 ↘ 3 W / 480 lm  
 ↘ 350 mA  
 ↘ CRI 90  
 ↘ MacAdam 3-Step

LED and driver included  
 LED e driver inclusi

### Metal structure Montatura in metallo

● Matte Black - 9005  
 Nero Opaco - 9005

● Extra Matte Champagne  
 Champagne Extra Opaco

● Terra  
 Terra

● Matte Black - 9005  
 Nero Opaco - 9005

● Extra Matte Champagne  
 Champagne Extra Opaco

● Terra  
 Terra

Black cable  
 Cavo Nero

Iva esclusa  
 Vat excluded

Code Codice	Euro €
17820 2020	195,00
17820 4520	205,00
17820 6720	215,00
17820 2035	195,00
17820 4535	205,00
17820 6735	215,00

Net weight/Peso netto: 0.58 kg    Pack/Colli: 1    Energy class/Classe energetica: 2700 K ▶ D - 3000 K ▶ C

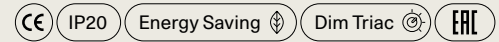

IVY V suspension lamps must only be installed on the single and central canopies below  
 Le lampade a sospensione IVY V devono essere installate solamente sui rosoni singoli e centrali di seguito

Ecodesign regulation ▶ pag. 084-085  
 Regolamento di Ecodesign ▶ pag. 084-085

### Single canopy

## Single Mini

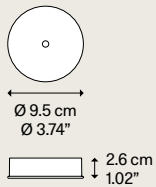

### Description Descrizione

Single ceiling  
 bracket small size  
 Rosone per  
 lampada singola  
 versione mini

### Methacrylate structure Struttura in metacrilato

● Matte Black - 9005  
 Nero Opaco - 9005

### System Sistema

Single

Iva esclusa  
 Vat excluded

Code Codice	Euro €
R11L01 2000	42,00

Net weight/Peso netto: 0.13 kg    Pack/Colli: 1



### Recessed canopy

## Recessed Micro

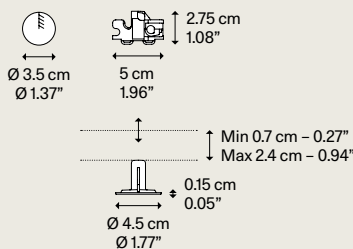

### Description Descrizione

Recessed bracket  
 for single lamp  
 max capacity  
 3.5 kg

Rosone da incasso  
 per lampada  
 singola portata  
 max 3.5 kg

### Methacrylate structure Struttura in metacrilato

● Matte Black  
 Nero Opaco

### System Sistema

Recessed

Iva esclusa  
 Vat excluded

Code Codice	Euro €
R01L01 2000	25,00

Net weight/Peso netto: 0.025 kg    Pack/Colli: 1

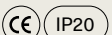

Suspension lamp  
 Cluster suspension lamp  
 Canopy  
 Wall & Ceiling lamp  
 Floor & Table lamp  
 Outdoor lamp  
 Accessory

# IVY V, design by Vittorio Massimo, 2022

Central canopy

## 6 Lights Central

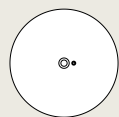

Ø 17.2 cm  
Ø 6.77"

Ø 16.2 cm  
Ø 6.37"

3,45 cm  
1.35"

Net weight/Peso netto: 0.90 kg

Pack/Colli: 1

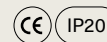

Description  
Descrizione

Central canopy  
max 6 suspension

Rosone centrale  
max 6 sospensioni

Metal structure  
Struttura in metallo

● Matte Black - 9005  
Nero Opaco - 9005

System  
Sistema

Cluster Central

Code  
Codice

R07L06 2000

Iva esclusa  
Vat excluded

Euro €  
145,00

## 12 Lights Central

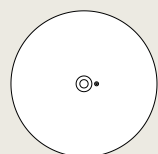

Ø 23.2 cm  
Ø 9.13"

Ø 22.2 cm  
Ø 8.74"

3,45 cm  
1.35"

Net weight/Peso netto: 1.20 kg

Pack/Colli: 1

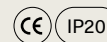

Description  
Descrizione

Central canopy  
max 12 suspension

Rosone centrale  
max 12  
sospensioni

Metal structure  
Struttura in metallo

● Matte Black - 9005  
Nero Opaco - 9005

System  
Sistema

Cluster Central

Code  
Codice

R07L12 2000

Iva esclusa  
Vat excluded

Euro €  
189,00



# JIM, design by Patrick Norguet, 2021

Suspension lamp

## JIM dome

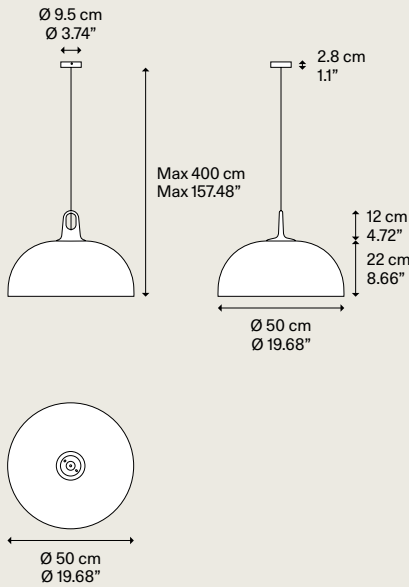

Light source  
Sorgente luminosa

Outside metal diffuser  
Diff. esterno in metallo

Inside metal diffuser  
Diff. interno in metallo

Hook  
Gancio

Code  
Codice

Iva esclusa  
Vat excluded  
Euro €

E27 A60 LED  
1 x 25 W

Bulb not included  
Lampadina non inclusa

Hook  
methacrylate  
Gancio in  
metacrilato

Matte White-9010  
Bianco Opaco-9010

Matte White-9010  
Bianco Opaco-9010

Grey  
Grigio

16924 2300 440,00

Matte Black-9005  
Nero Opaco-9005

Matte White-9010  
Bianco Opaco-9010

Honey  
Miele

16924 6300 440,00

Matte Champagne  
Champagne Opaco

Matte White-9010  
Bianco Opaco-9010

Grey  
Grigio

16924 2800 505,00

Honey  
Miele

16924 6600 505,00

Grey  
Grigio

16924 2700 515,00

Honey  
Miele

16924 6500 515,00

Coppery Bronze  
Bronzo Ramato

Matte White-9010  
Bianco Opaco-9010

Grey  
Grigio

16924 2400 515,00

Honey  
Miele

16924 6400 515,00

Net weight / Peso netto: 2.2 kg

Pack / Colli: 2



IP20

Energy Saving

Dim



Suspension lamp

Cluster suspension lamp

Canopy

Wall & Ceiling lamp

Floor & Table lamp

Outdoor lamp

Accessory

# Sky-Fall, design by Studio Italia Design, 2014

Suspension lamp

## Sky-Fall medium

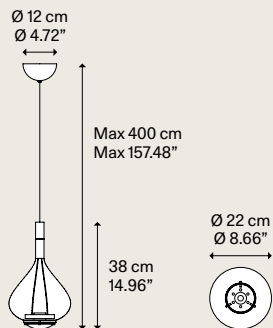

**Light source**  
Sorgente luminosa

**Metal structure**  
Montatura in metallo

**Blown glass diffuser**  
Diffusore in vetro soffiato

**Code**  
Codice

Iva esclusa  
Vat excluded  
**Euro €**

LED  
 ↘ 2700 K  
 ↘ 2 × 10 W/1815 lm  
 ↘ 350 mA  
 ↘ CRI 95  
 ↘ MacAdam 3-Step

Chrome Cromo

Clear Trasparente

14822 0027 570,00

Chrome Cromo

14822 4027 695,00

Glossy Smoke Fumo Lucido

14822 4327 695,00

Glossy Bronze Bronzo Lucido

14822 4627 695,00

Rose Gold Oro Rosa

14822 5527 695,00

or

Clear Trasparente

14822 0030 570,00

Chrome Cromo

14822 4030 695,00

Glossy Smoke Fumo Lucido

14822 4330 695,00

Glossy Bronze Bronzo Lucido

14822 4630 695,00

Rose Gold Oro Rosa

14822 5530 695,00

LED and driver included  
LED e driver inclusi

Net weight/Peso netto: 1.65 kg

Pack/Colli: 2

Energy class/Classe energetica: E

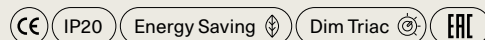

## Sky-Fall large

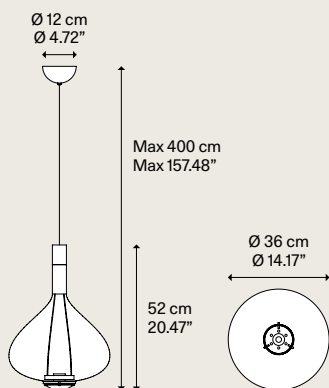

**Light source**  
Sorgente luminosa

**Metal structure**  
Montatura in metallo

**Blown glass diffuser**  
Diffusore in vetro soffiato

**Code**  
Codice

Iva esclusa  
Vat excluded  
**Euro €**

LED  
 ↘ 2700 K  
 ↘ 2 × 10 W/1815 lm  
 ↘ 350 mA  
 ↘ CRI 95  
 ↘ MacAdam 3-Step

Chrome Cromo

Clear Trasparente

14821 0027 785,00

Chrome Cromo

14821 4027 1060,00

Glossy Smoke Fumo Lucido

14821 4327 1060,00

Glossy Bronze Bronzo Lucido

14821 4627 1060,00

Rose Gold Oro Rosa

14821 5527 1060,00

or

Clear Trasparente

14821 0030 785,00

Chrome Cromo

14821 4030 1060,00

Glossy Smoke Fumo Lucido

14821 4330 1060,00

Glossy Bronze Bronzo Lucido

14821 4630 1060,00

Rose Gold Oro Rosa

14821 5530 1060,00

LED and driver included  
LED e driver inclusi

Net weight/Peso netto: 3.05 kg

Pack/Colli: 2

Energy class/Classe energetica: E

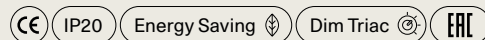

Ecodesign regulation ► pag. 084-085  
Regolamento di Ecodesign ► pag. 084-085

# Sky-Fall, design by Studio Italia Design, 2014

## Canopy

### Sky-Fall double canopy

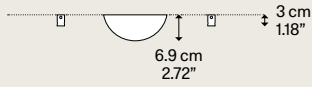
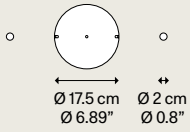

Net weight/Peso netto: 0.90 kg

Pack/Colli: 1

CE IP20

## Wall Bracket

### Sky-Fall wall

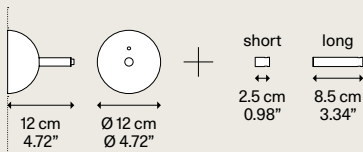

Net weight/Peso netto: 0.4 kg

Pack/Colli: 1

CE IP20

Description Descrizione	Metal structure Montatura in metallo	System Sistema	Code Codice	Iva esclusa Vat excluded Euro €
Double canopy mod. Sky-Fall	Chrome Cromo	Sky-Fall System	R99L02 4000	190,00
Rosone doppio mod. Sky-Fall				

Description Descrizione	Metal structure Montatura in metallo	System Sistema	Code Codice	Iva esclusa Vat excluded Euro €
Wall bracket mod. Sky-Fall	Chrome Cromo	Sky-Fall System	R99L01 4000	115,00
Rosone a parete mod. Sky-Fall				

Suspension lamp

Cluster suspension lamp

Canopy

Wall & Ceiling lamp

Floor & Table lamp

Outdoor lamp

Accessory

# Sky-Fall, design by Studio Italia Design, 2014

Track

## Short Lights Track

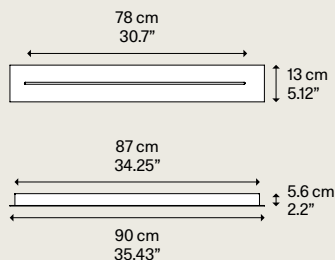

Net weight/Peso netto: 5.5 kg

Pack/Colli: 1

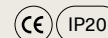

**Description**  
Descrizione

Multiple linear track mod. Sky-Fall max 3 suspensions

Binario lineare multiplo mod. Sky-Fall max 3 sospensioni

**Structure finish**  
Finitura struttura

● Matte White - 9010  
Bianco Opaco - 9010

● Matte Black - 9005  
Nero Opaco - 9005

**System**  
Sistema

Track

**Code**  
Codice

R08L07 1000

R08L07 2000

Iva esclusa  
Vat excluded

**Euro €**

370,00

370,00

## Long Lights Track

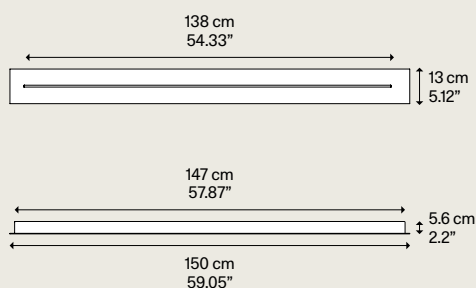

Net weight/Peso netto: 8.8 kg

Pack/Colli: 1

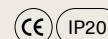

**Description**  
Descrizione

Multiple linear track mod. Sky-Fall max 5 suspensions

Binario lineare multiplo mod. Sky-Fall max 5 sospensioni

**Structure finish**  
Finitura struttura

● Matte White - 9010  
Bianco Opaco - 9010

● Matte Black - 9005  
Nero Opaco - 9005

**System**  
Sistema

Track

**Code**  
Codice

R08L11 1000

R08L11 2000

Iva esclusa  
Vat excluded

**Euro €**

620,00

620,00

TRACK ► Tracks are only for Sky-Fall suspensions. Each suspension should be separated from the canopy and installed on the track. Each suspension should be installed on the track using the driver removed from the original canopy.

TRACK ► I binari sono utilizzabili solo con le sospensioni Sky-Fall che dovranno essere separate dai rosconi ed installate sui binari. Per ogni sospensione dovrà essere installato nel binario il rispettivo driver rimosso dal roscone originale.

# Kelly, design by Andrea Toso, 2015

Suspension lamp

## Kelly small dome 50

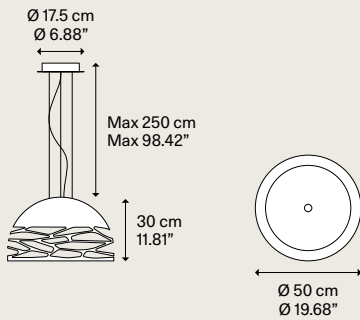

Net weight / Peso netto: 6 kg    Pack / Colli: 1

### Light source Sorgente luminosa

E27 Classic A60  
3 × max 46 W Eco



or

E27 LED  
3 × 25 W



W/L max 12 cm  
W/L max 4.72"

Bulbs not included  
Lampadine non include

### Metal structure Montatura in metallo

Matte White - 9010  
Bianco Opaco - 9010

Matte Black - 9005  
Nero Opaco - 9005

Coppery Bronze  
Bronzo Ramato

Matte Champagne  
Champagne Opaco

### Glass diffuser Diffusore in vetro

Glossy White  
Bianco Lucido

Iva esclusa  
Vat excluded  
Code  
Codice    Euro €

14126 1000    545,00

14126 2000    545,00

14126 3500    580,00

14126 4500    580,00

CE IP20 Energy Saving Dim EAC

## Kelly medium dome 60

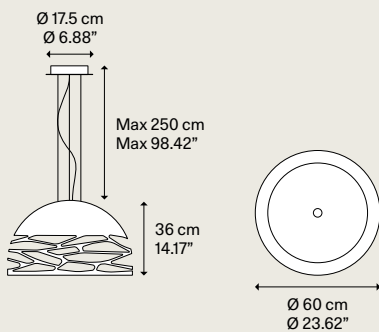

Net weight / Peso netto: 7.15 kg    Pack / Colli: 1

### Light source Sorgente luminosa

E27 Classic A60  
3 × max 46 W Eco



or

E27 LED  
3 × 25 W



W/L max 12 cm  
W/L max 4.72"

Bulbs not included  
Lampadine non include

### Metal structure Montatura in metallo

Matte White - 9010  
Bianco Opaco - 9010

Matte Black - 9005  
Nero Opaco - 9005

Coppery Bronze  
Bronzo Ramato

Matte Champagne  
Champagne Opaco

### Glass diffuser Diffusore in vetro

Glossy White  
Bianco Lucido

Iva esclusa  
Vat excluded  
Code  
Codice    Euro €

14127 1000    850,00

14127 2000    850,00

14127 3500    880,00

14127 4500    880,00

CE IP20 Energy Saving Dim EAC

## Kelly large dome 80

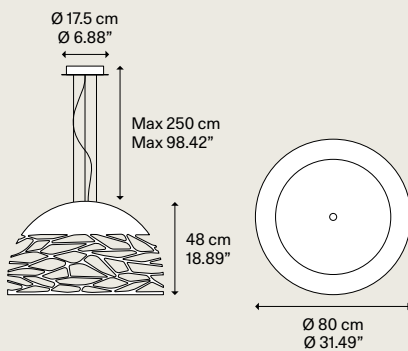

Net weight / Peso netto: 11 kg    Pack / Colli: 1

### Light source Sorgente luminosa

E27 Classic A60  
4 × max 46 W Eco



or

E27 LED  
4 × 25 W



W/L max 12 cm  
W/L max 4.72"

Bulbs not included  
Lampadine non include

### Metal structure Montatura in metallo

Matte White - 9010  
Bianco Opaco - 9010

Matte Black - 9005  
Nero Opaco - 9005

Coppery Bronze  
Bronzo Ramato

Matte Champagne  
Champagne Opaco

### Glass diffuser Diffusore in vetro

Glossy White  
Bianco Lucido

Iva esclusa  
Vat excluded  
Code  
Codice    Euro €

14128 1000    1050,00

14128 2000    1050,00

14128 3500    1100,00

14128 4500    1100,00

CE IP20 Energy Saving Dim EAC

Suspension lamp  
Cluster suspension lamp  
Canopy  
Wall & Ceiling lamp  
Floor & Table lamp  
Outdoor lamp  
Accessory

# Kelly, design by Andrea Tosetto, 2015

Suspension lamp

## Kelly small sphere 40

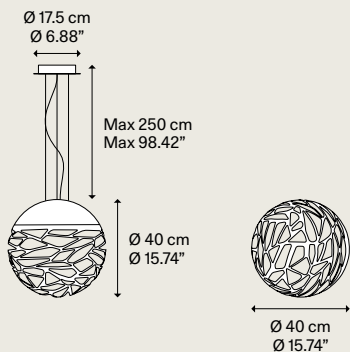

### Light source Sorgente luminosa

E27 Classic A60  
↗ 3 × max 46 W Eco



or

E27 LED  
↗ 3 × 25 W



W/L max 12 cm  
W/L max 4.72"

Bulbs not included  
Lampadine non include

### Metal structure Montatura in metallo

Matte White - 9010  
Bianco Opaco - 9010



Copperty Bronze  
Bronzo Ramato



### Glass diffuser Diffusore in vetro

Glossy White  
Bianco Lucido



### Code Codice

14122 1000

14122 3500

Iva esclusa  
Vat excluded

Euro €

890,00

915,00

Net weight/Peso netto: 5.5 kg

Pack/Colli: 2

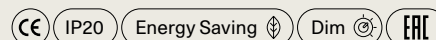

## Kelly medium sphere 50

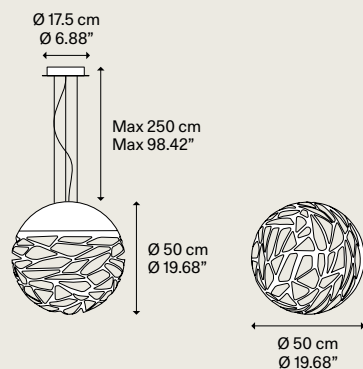

### Light source Sorgente luminosa

E27 Classic A60  
↗ 3 × max 46 W Eco



or

E27 LED  
↗ 3 × 25 W



W/L max 12 cm  
W/L max 4.72"

Bulbs not included  
Lampadine non include

### Metal structure Montatura in metallo

Matte White - 9010  
Bianco Opaco - 9010



Copperty Bronze  
Bronzo Ramato



### Glass diffuser Diffusore in vetro

Glossy White  
Bianco Lucido



### Code Codice

14123 1000

14123 3500

Iva esclusa  
Vat excluded

Euro €

1175,00

1200,00

Net weight/Peso netto: 9 kg

Pack/Colli: 2

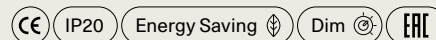

## Kelly large sphere 80

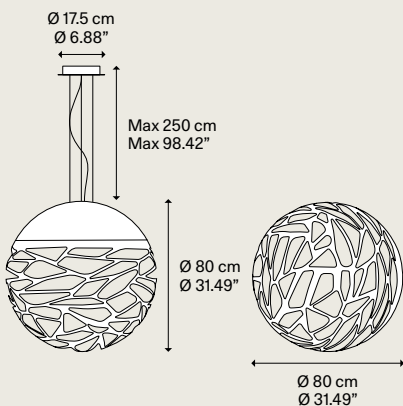

### Light source Sorgente luminosa

E27 Classic A60  
↗ 4 × max 46 W Eco



or

E27 LED  
↗ 4 × 25 W



W/L max 12 cm  
W/L max 4.72"

Bulbs not included  
Lampadine non include

### Metal structure Montatura in metallo

Matte White - 9010  
Bianco Opaco - 9010



Copperty Bronze  
Bronzo Ramato



### Glass diffuser Diffusore in vetro

Glossy White  
Bianco Lucido



### Code Codice

14124 1000

14124 3500

Iva esclusa  
Vat excluded

Euro €

3185,00

3240,00

Net weight/Peso netto: 15 kg

Pack/Colli: 2

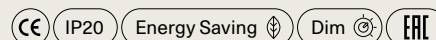

# Volum, design by Snøhetta, 2022

Suspension lamp

## Volum 42

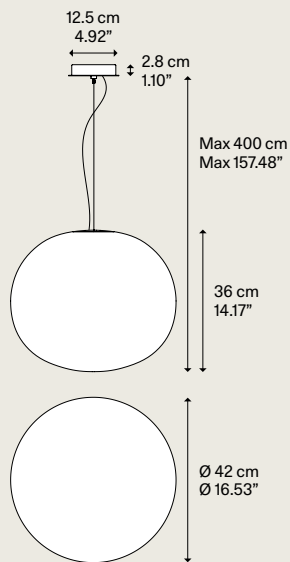

Net weight/ Peso netto: 4 kg

Pack/ Colli: 2

**Light source**  
Sorgente luminosa

E27 LED  
1 × 25 W

Ø max 9.8 cm  
Ø max 3.74"

Bulb not included  
Lampadina non  
inclusa

**Methacrylate structure**  
Struttura in metacrilato

Glossy White  
Bianco Lucido

**Blown glass diffuser**  
Diffusore in vetro soffiato

Glossy White  
Bianco Lucido

**Code**  
Codice

18720 1200

Iva esclusa  
Vat excluded  
**Euro €**

480,00

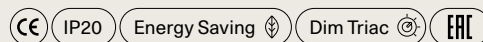

Suspension lamp

Cluster suspension lamp

Canopy

Wall & Ceiling lamp

Floor & Table lamp

Outdoor lamp

Accessory

# Cluster suspension lamps

## Cluster suspension lamps

---



A-Tube  
Pag. 015, 016



A-Tube Nano  
Pag. 017-020



A-Tube Nano Duo  
Pag. 021

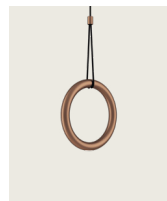

IVY I  
Pag. 022



Jefferson  
Pag. 023

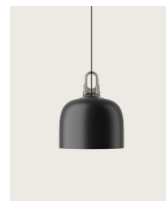

JIM  
Pag. 024, 025



Kelly Cluster  
Pag. 026

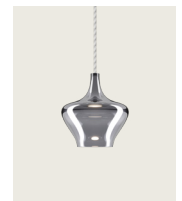

Nostalgia  
Pag. 027-029

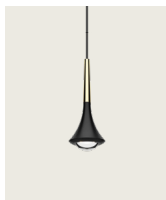

Rain  
Pag. 030, 031



Random  
Pag. 032

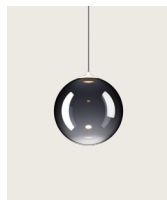

Random Solo  
Pag. 033-037

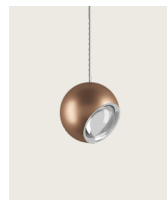

Spider  
Pag. 038



Volum  
Pag. 039



# A-Tube, design by Studio Italia Design, 2013

Cluster suspension lamp

## A-Tube small

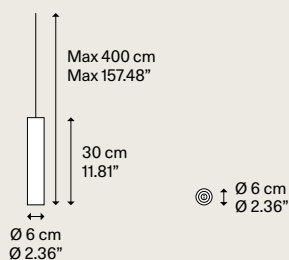

Net weight/Peso netto: 1.12 kg

Pack/Colli: 1

### Light source Sorgente luminosa

GU10 Par 16  
↘ 1 × max 40W Eco



GU10 Par 16 LED  
↘ 1 × 10 W

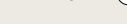

W/L max 8.5 cm  
W/L max 3.34"

Bulb not included  
Lampadina non inclusa

### Metal structure Montatura in metallo

Matte White - 9010  
Bianco Opaco - 9010

Matte Black - 9005  
Nero Opaco - 9005

Coppery Bronze  
Bronzo Ramato

Iva esclusa  
Vat excluded  
Code  
Codice Euro €

09622 1000 170,00

09622 2000 170,00

09622 3500 175,00

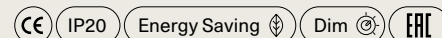

## A-Tube medium

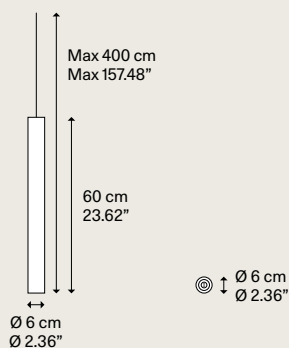

Net weight/Peso netto: 1.42 kg

Pack/Colli: 1

### Light source Sorgente luminosa

GU10 Par 16  
↘ 1 × max 40W Eco



GU10 Par 16 LED  
↘ 1 × 10 W

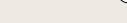

W/L max 8.5 cm  
W/L max 3.34"

Bulb not included  
Lampadina non inclusa

### Metal structure Montatura in metallo

Matte White - 9010  
Bianco Opaco - 9010

Matte Black - 9005  
Nero Opaco - 9005

Coppery Bronze  
Bronzo Ramato

Iva esclusa  
Vat excluded  
Code  
Codice Euro €

09623 1000 245,00

09623 2000 245,00

09623 3500 260,00

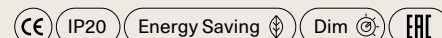

## A-Tube large

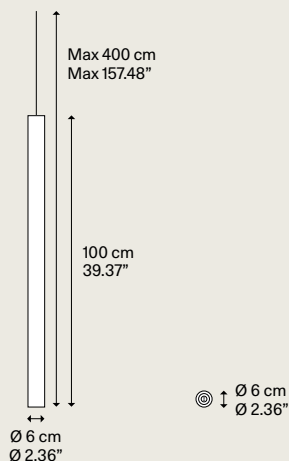

Net weight/Peso netto: 1.87 kg

Pack/Colli: 1

### Light source Sorgente luminosa

GU10 Par 16  
↘ 1 × max 40W Eco



GU10 Par 16 LED  
↘ 1 × 10 W

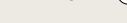

W/L max 8.5 cm  
W/L max 3.34"

Bulb not included  
Lampadina non inclusa

### Metal structure Montatura in metallo

Matte White - 9010  
Bianco Opaco - 9010

Matte Black - 9005  
Nero Opaco - 9005

Coppery Bronze  
Bronzo Ramato

Iva esclusa  
Vat excluded  
Code  
Codice Euro €

09624 1000 325,00

09624 2000 325,00

09624 3500 355,00

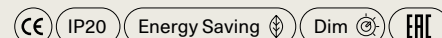

Suspension lamps must be installed on a canopy ► pag. 040-049  
Le lampade a sospensione devono essere installate su rosone ► pag. 040-049

Suspension lamp  
Cluster suspension lamp  
Canopy  
Wall & Ceiling lamp  
Floor & Table lamp  
Outdoor lamp  
Accessory

# A-Tube, design by Studio Italia Design, 2013

Example of composition

5 Lights Round

R04L05 1000

3 × 09623 1000

2 × 09624 1000

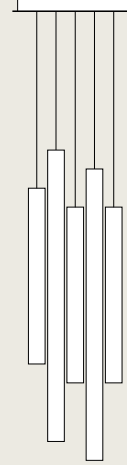
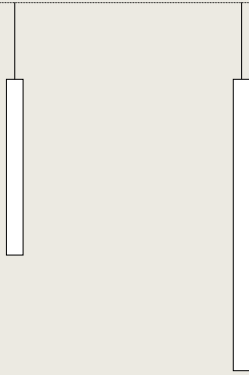
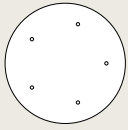

Example of composition

7 Lights Rectangular

R05L07 2000

3 × 09622 2000

2 × 09623 2000

2 × 09623 3500

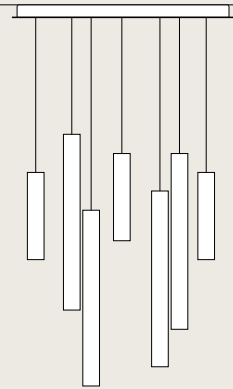
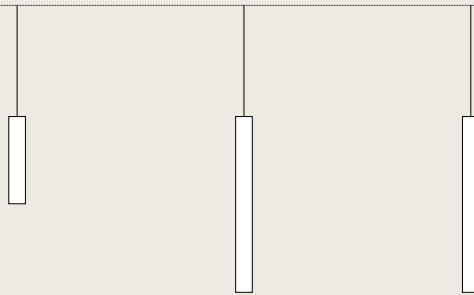
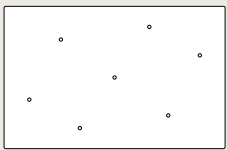

Example of composition

Short Lights Track

R08L07 2000

5 × 09623 3500

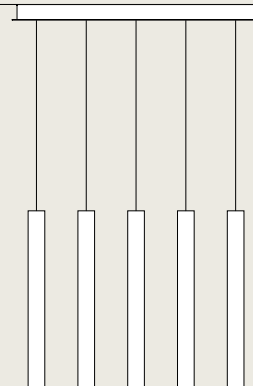
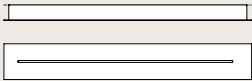

Suspension lamps must be installed on a canopy ▶ pag. 040-049  
Le lampade a sospensione devono essere installate su rosone ▶ pag. 040-049

# A-Tube Nano, design by Studio Italia Design, 2016

Cluster suspension lamp

## A-Tube Nano small

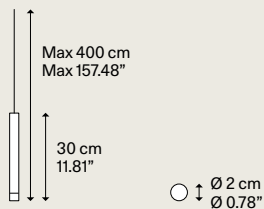

Light source Sorgente luminosa	Metal structure Montatura in metallo	Methacrylate diffuser Diffusore in metacrilato	Code Codice	Iva esclusa Vat excluded Euro €	
LED ↘ 2700 K ↘ 3 W/450 lm ↘ 350 mA ↘ CRI 90 ↘ MacAdam 3-Step  LED and driver included LED e driver inclusi	Matte White - 9010 Bianco Opaco - 9010	Clear Trasparente	15822 1020	145,00	
	Matte Black - 9005 Nero Opaco - 9005		15822 2020	145,00	
	Chrome Cromo		15822 4020	170,00	
	Matte Champagne Champagne Opaco		15822 4520	155,00	
	Gold Oro		15822 5020	175,00	
	Rose Gold Oro Rosa		15822 5520	170,00	
	Terra Terra		Transparent cable Cavo Trasparente	15822 6720	170,00
	Matte White - 9010 Bianco Opaco - 9010		Black cable Cavo Nero	15826 1020	145,00
	Matte Black - 9005 Nero Opaco - 9005			15826 2020	145,00
	Chrome Cromo			15826 4020	170,00
Matte Champagne Champagne Opaco	Clear Trasparente	15826 4520		155,00	
LED ↘ 3000 K ↘ 3 W/480 lm ↘ 350 mA ↘ CRI 90 ↘ MacAdam 3-Step  LED and driver included LED e driver inclusi	Gold Oro	Clear Trasparente	15826 5020	175,00	
	Rose Gold Oro Rosa		15826 5520	170,00	
	Terra Terra		15826 6720	170,00	
	Matte White - 9010 Bianco Opaco - 9010		Black cable Cavo Nero	15822 1035	145,00
	Matte Black - 9005 Nero Opaco - 9005			15822 2035	145,00
	Chrome Cromo			15822 4035	170,00
	Matte Champagne Champagne Opaco			Clear Trasparente	15822 4535
	Gold Oro		Transparent cable Cavo Trasparente	15822 5035	175,00
	Rose Gold Oro Rosa			15822 5535	170,00
	Terra Terra			15822 6735	170,00
Matte White - 9010 Bianco Opaco - 9010	15826 1035	145,00			
Matte Black - 9005 Nero Opaco - 9005	15826 2035	145,00			
Chrome Cromo	15826 4035	170,00			
LED and driver included LED e driver inclusi	Matte Champagne Champagne Opaco	Clear Trasparente	15826 4535	155,00	
	Gold Oro	Black cable Cavo Nero	15826 5035	175,00	
	Rose Gold Oro Rosa		15826 5535	170,00	
	Terra Terra		15826 6735	170,00	
	Matte Champagne Champagne Opaco		Clear Trasparente	15826 4535	155,00
Gold Oro	15826 5035		175,00		
LED and driver included LED e driver inclusi	Rose Gold Oro Rosa	Black cable Cavo Nero	15826 5535	170,00	
	Terra Terra		15826 6735	170,00	
	Matte Champagne Champagne Opaco		Clear Trasparente	15826 4535	155,00
LED and driver included LED e driver inclusi	Gold Oro	Black cable Cavo Nero	15826 5035	175,00	
	Rose Gold Oro Rosa		15826 5535	170,00	
	Terra Terra		15826 6735	170,00	

or

Net weight/Peso netto: 0.25 kg

Pack/Colli: 2

Energy class/Classe energetica: D



IP20

Energy Saving

Dim Triac



# A-Tube Nano, design by Studio Italia Design, 2016

Cluster suspension lamp

## A-Tube Nano medium

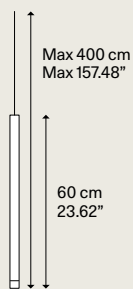

Ø 2 cm  
Ø 0.78"

Light source Sorgente luminosa	Metal structure Montatura in metallo	Methacrylate diffuser Diffusore in metacrilato	Code Codice	Iva esclusa Vat excluded Euro €
LED ↘ 2700 K ↘ 3 W/450 lm ↘ 350 mA ↘ CRI 90 ↘ MacAdam 3-Step  LED and driver included LED e driver inclusi	Matte White - 9010 Bianco Opaco - 9010		15823 1020	160,00
	Matte Black - 9005 Nero Opaco - 9005		15823 2020	160,00
	Chrome Cromo		15823 4020	185,00
	Matte Champagne Champagne Opaco	Clear Trasparente	15823 4520	170,00
	Gold Oro		15823 5020	190,00
	Rose Gold Oro Rosa		15823 5520	185,00
	Terra Terra	Transparent cable Cavo Trasparente	15823 6720	185,00
	Matte White - 9010 Bianco Opaco - 9010		15827 1020	160,00
	Matte Black - 9005 Nero Opaco - 9005		15827 2020	160,00
	Chrome Cromo		15827 4020	185,00
	Matte Champagne Champagne Opaco	Clear Trasparente	15827 4520	170,00
	or  LED ↘ 3000 K ↘ 3 W/480 lm ↘ 350 mA ↘ CRI 90 ↘ MacAdam 3-Step  LED and driver included LED e driver inclusi	Gold Oro		15827 5020
Rose Gold Oro Rosa			15827 5520	185,00
Terra Terra		Black cable Cavo Nero	15827 6720	185,00
Matte White - 9010 Bianco Opaco - 9010			15823 1035	160,00
Matte Black - 9005 Nero Opaco - 9005			15823 2035	160,00
Chrome Cromo			15823 4035	185,00
Matte Champagne Champagne Opaco		Clear Trasparente	15823 4535	170,00
Gold Oro			15823 5035	190,00
Rose Gold Oro Rosa			15823 5535	185,00
Terra Terra		Transparent cable Cavo Trasparente	15823 6735	185,00
Matte White - 9010 Bianco Opaco - 9010			15827 1035	160,00
Matte Black - 9005 Nero Opaco - 9005			15827 2035	160,00
Chrome Cromo		15827 4035	185,00	
Matte Champagne Champagne Opaco	Clear Trasparente	15827 4535	170,00	
Gold Oro		15827 5035	190,00	
Rose Gold Oro Rosa		15827 5535	185,00	
Terra Terra	Black cable Cavo Nero	15827 6735	185,00	

Net weight/Peso netto: 0.3 kg

Pack/Colli: 2

Energy class/Classe energetica: D

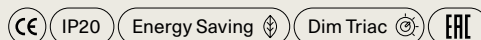

# A-Tube Nano, design by Studio Italia Design, 2016

Cluster suspension lamp

## A-Tube Nano large

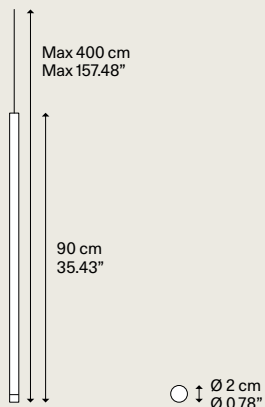

Light source Sorgente luminosa	Metal structure Montatura in metallo	Methacrylate diffuser Diffusore in metacrilato	Code Codice	Iva esclusa Vat excluded Euro €		
LED ↘ 2700 K ↘ 3 W/450 lm ↘ 350 mA ↘ CRI 90 ↘ MacAdam 3-Step	Matte White - 9010 Bianco Opaco - 9010	Clear Trasparente	15824 1020	175,00		
	Matte Black - 9005 Nero Opaco - 9005		15824 2020	175,00		
	Chrome Cromo		15824 4020	210,00		
	Matte Champagne Champagne Opaco		15824 4520	185,00		
	Gold Oro		15824 5020	220,00		
	Rose Gold Oro Rosa		15824 5520	210,00		
	Terra Terra		Transparent cable Cavo Trasparente	15824 6720	210,00	
	Matte White - 9010 Bianco Opaco - 9010		Black cable Cavo Nero	15828 1020	175,00	
	Matte Black - 9005 Nero Opaco - 9005			15828 2020	175,00	
	Chrome Cromo			15828 4020	210,00	
	Matte Champagne Champagne Opaco			Clear Trasparente	15828 4520	185,00
	Gold Oro			15828 5020	220,00	
	Rose Gold Oro Rosa			15828 5520	210,00	
	Terra Terra			15828 6720	210,00	
	Matte White - 9010 Bianco Opaco - 9010			Clear Trasparente	15824 1035	175,00
Matte Black - 9005 Nero Opaco - 9005	15824 2035	175,00				
Chrome Cromo	15824 4035	210,00				
Matte Champagne Champagne Opaco	15824 4535	185,00				
Gold Oro	15824 5035	220,00				
Rose Gold Oro Rosa	15824 5535	210,00				
Terra Terra	Transparent cable Cavo Trasparente	15824 6735			210,00	
Matte White - 9010 Bianco Opaco - 9010	Black cable Cavo Nero	15828 1035			175,00	
Matte Black - 9005 Nero Opaco - 9005		15828 2035	175,00			
Chrome Cromo		15828 4035	210,00			
Matte Champagne Champagne Opaco		Clear Trasparente	15828 4535		185,00	
Gold Oro		15828 5035	220,00			
Rose Gold Oro Rosa		15828 5535	210,00			
Terra Terra		15828 6735	210,00			

or

LED  
↘ 3000 K  
↘ 3 W/480 lm  
↘ 350 mA  
↘ CRI 90  
↘ MacAdam 3-Step

LED and driver included  
LED e driver inclusi

Net weight/Peso netto: 0.59 kg    Pack/Colli: 2    Energy class/Classe energetica: D

CE IP20 Energy Saving Dim Triac EAC

Suspension lamp  
Cluster suspension lamp  
Canopy  
Wall & Ceiling lamp  
Floor & Table lamp  
Outdoor lamp  
Accessory

# A-Tube Nano, *design by Studio Italia Design, 2016*

Example of composition

5 Lights Round

R04L05 1000

2 × 15822 4520

1 × 15823 4520

2 × 15824 4520

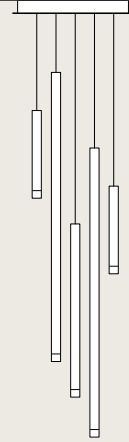
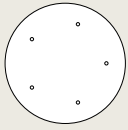

Example of composition

7 Lights Rectangular

R05L07 2000

3 × 15822 2020

4 × 15823 5020

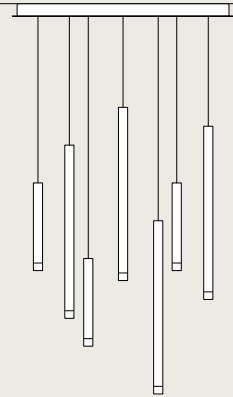
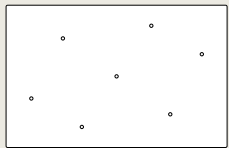

Example of composition

Short Lights Track

R08L07 2000

5 × 15823 6720

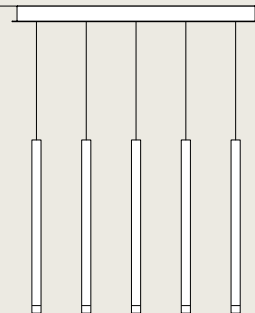
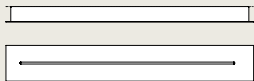

Suspension lamps must be installed on a canopy ▶ pag. 040–049  
Le lampade a sospensione devono essere installate su rosone ▶ pag. 040–049

Ecodesign regulation ▶ pag. 084–085  
Regolamento di Ecodesign ▶ pag. 084–085

# A-Tube Nano Duo, design by Studio Italia Design, 2017

Cluster suspension lamp

## A-Tube Nano Duo

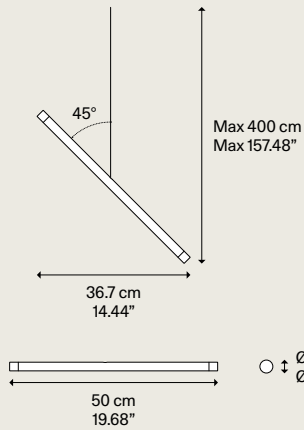



**Light source**  
Sorgente luminosa

LED  
 ▸ 2700 K  
 ▸ 2 × 1 W / 300 lm  
 ▸ 350 mA  
 ▸ CRI 90  
 ▸ MacAdam 3-Step

LED and driver included  
 LED e driver inclusi

**Metal structure**  
Montatura in metallo

-  Matte White - 9010  
Bianco Opaco - 9010
-  Matte Black - 9005  
Nero Opaco - 9005
-  Chrome  
Cromo
-  Matte Champagne  
Champagne Opaco
-  Gold  
Oro
-  Rose Gold  
Oro Rosa

**Methacrylate diffuser**  
Diffusore in metacrilato

 Clear  
Trasparente

**Code**  
Codice

Iva esclusa  
Vat excluded  
**Euro €**

15825 1020	180,00
15825 2020	180,00
15825 4020	205,00
15825 4520	190,00
15825 5020	210,00
15825 5520	205,00

Net weight/Peso netto: 0.21 kg

Pack/Colli: 1

Energy class/Classe energetica: D

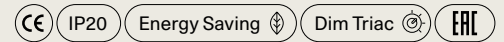

Suspension lamps must be installed on a canopy ▶ pag. 040-049  
 Le lampade a sospensione devono essere installate su rosone ▶ pag. 040-049

Ecodesign regulation ▶ pag. 084-085  
 Regolamento di Ecodesign ▶ pag. 084-085

Example of composition

5 Lights Round

R04L05 1000

1 × 15825 2020

2 × 15825 4020

2 × 15825 5020

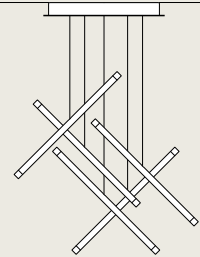
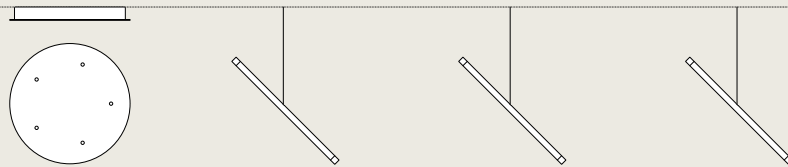

Example of composition

7 Lights Rectangular

R05L07 1000

2 × 15825 1020

4 × 15825 4020

1 × 15825 4520

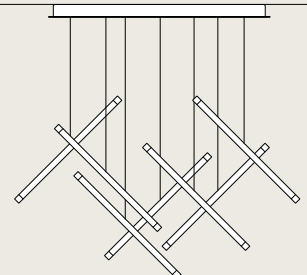
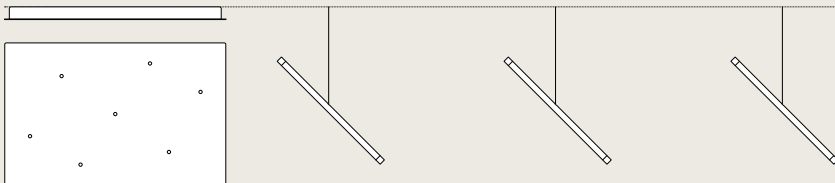

Suspension lamp  
 Cluster suspension lamp  
 Canopy  
 Wall & Ceiling lamp  
 Floor & Table lamp  
 Outdoor lamp  
 Accessory

# IVY I, design by Vittorio Massimo, 2022

Cluster suspension lamp

## IVY I

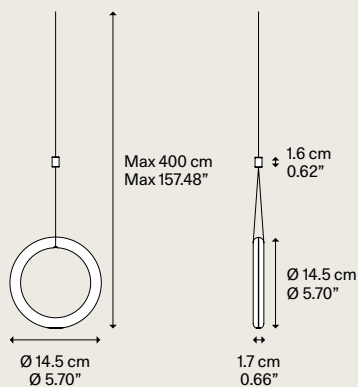

### Light source Sorgente luminosa

LED  
 ↘ 2700 K  
 ↘ 3 W / 450 lm  
 ↘ 350 mA  
 ↘ CRI 90  
 ↘ MacAdam 3-Step

or

LED  
 ↘ 3000 K  
 ↘ 3 W / 480 lm  
 ↘ 350 mA  
 ↘ CRI 90  
 ↘ MacAdam 3-Step

LED and driver included  
 LED e driver inclusi

### Metal structure Montatura in metallo

● Matte Black - 9005  
 Nero Opaco - 9005

● Extra Matte Champagne  
 Champagne Extra Opaco

● Terra  
 Terra

● Matte Black - 9005  
 Nero Opaco - 9005

● Extra Matte Champagne  
 Champagne Extra Opaco

● Terra  
 Terra

Black cable  
 Cavo Nero

### Code Codice

17810 2020

17810 4520

17810 6720

17810 2035

17810 4535

17810 6735

Iva esclusa  
 Vat excluded

Euro €

165,00

175,00

185,00

165,00

175,00

185,00

Net weight/Peso netto: 0.5 kg

Pack/Colli: 1

Energy class/Classe energetica: 2700 K ▶ D - 3000 K ▶ C



IP20

Energy Saving

Dim Triac



Suspension lamps must be installed on a canopy ▶ pag. 040-049  
 Le lampade a sospensione devono essere installate su rosone ▶ pag. 040-049

Ecodesign regulation ▶ pag. 084-085  
 Regolamento di Ecodesign ▶ pag. 084-085

Example of composition

Short Lights Track

R08L07 1000

5 × 17810 2020

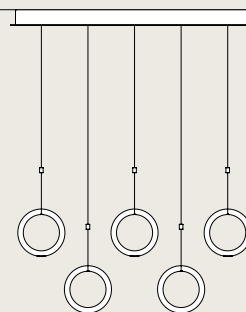
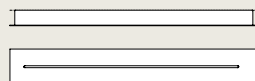

Example of composition

7 Lights Round

R04L07 2000

3 × 17810 2020

2 × 17810 4520

2 × 17810 6720

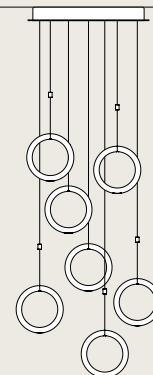
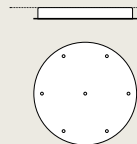



# Jefferson, design by Luca Nichetto, 2019

Cluster suspension lamp

## Jefferson mini

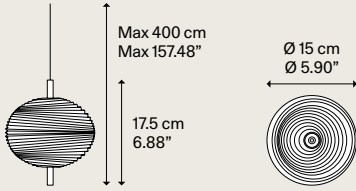

**Light source**  
Sorgente luminosa

LED  
 ↘ 2700 K  
 ↘ 3 W / 450 lm  
 ↘ 350 mA  
 ↘ CRI 90  
 ↘ MacAdam 3-Step

LED and driver included  
 LED e driver inclusi

**Metal structure**  
Montatura in metallo

● Black Chrome  
Cromo Nero

● Gold  
Oro

**Bohemian crystal diffuser**  
Diffusore in cristallo di Boemia

● Clear  
Trasparente

● Clear  
Trasparente

**Code**  
Codice

16821 4227

16821 5027

Iva esclusa  
Vat excluded

**Euro €**

265,00

275,00

Net weight/Peso netto: 1.40 kg

Pack/Colli: 1

Energy class/Classe energetica: D



IP20

Energy Saving

Dim Triac



## Jefferson small

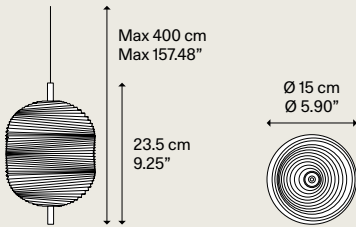

**Light source**  
Sorgente luminosa

LED  
 ↘ 2700 K  
 ↘ 3 W / 450 lm  
 ↘ 350 mA  
 ↘ CRI 90  
 ↘ MacAdam 3-Step

LED and driver included  
 LED e driver inclusi

**Metal structure**  
Montatura in metallo

● Black Chrome  
Cromo Nero

● Gold  
Oro

**Bohemian crystal diffuser**  
Diffusore in cristallo di Boemia

● Clear  
Trasparente

● Clear  
Trasparente

**Code**  
Codice

16822 4227

16822 5027

Iva esclusa  
Vat excluded

**Euro €**

345,00

355,00

Net weight/Peso netto: 2.10 kg

Pack/Colli: 1

Energy class/Classe energetica: D



IP20

Energy Saving

Dim Triac



## Jefferson medium

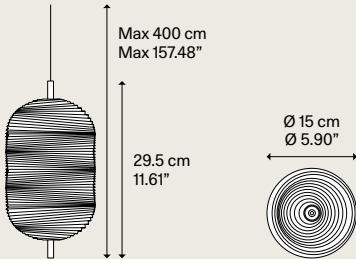

**Light source**  
Sorgente luminosa

LED  
 ↘ 2700 K  
 ↘ 3 W / 450 lm  
 ↘ 350 mA  
 ↘ CRI 90  
 ↘ MacAdam 3-Step

LED and driver included  
 LED e driver inclusi

**Metal structure**  
Montatura in metallo

● Black Chrome  
Cromo Nero

● Gold  
Oro

**Bohemian crystal diffuser**  
Diffusore in cristallo di Boemia

● Clear  
Trasparente

● Clear  
Trasparente

**Code**  
Codice

16823 4227

16823 5027

Iva esclusa  
Vat excluded

**Euro €**

430,00

440,00

Net weight/Peso netto: 2.80 kg

Pack/Colli: 1

Energy class/Classe energetica: D



IP20

Energy Saving

Dim Triac



Suspension lamps must be installed on a canopy ▶ pag. 040-049  
 Le lampade a sospensione devono essere installate su rosone ▶ pag. 040-049

Ecodesign regulation ▶ pag. 084-085  
 Regolamento di Ecodesign ▶ pag. 084-085

# JIM, design by Patrick Norguet, 2021

## Cluster suspension lamp

### JIM bell

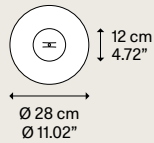
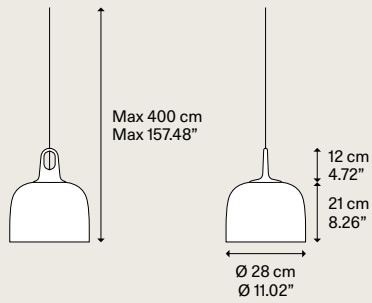

Light source  
Sorgente luminosa

E27 A60 LED  
1 x 25 W

Bulb not included  
Lampadina non inclusa

Outside metal diffuser  
Diff. esterno in metallo

Matte White-9010  
Bianco Opaco-9010

Matte Black-9005  
Nero Opaco-9005

Matte Champagne  
Champagne Opaco

Coppery Bronze  
Bronzo Ramato

Inside metal diffuser  
Diff. interno in metallo

Matte White-9010  
Bianco Opaco-9010

Matte White-9010  
Bianco Opaco-9010

Matte White-9010  
Bianco Opaco-9010

Matte White-9010  
Bianco Opaco-9010

Hook  
Gancio

Grey  
Grigio

Honey  
Miele

Grey  
Grigio

Honey  
Miele

Grey  
Grigio

Honey  
Miele

Grey  
Grigio

Honey  
Miele

Hook  
methacrylate  
Gancio in  
metacrilato

Code  
Codice

16921 2300

16921 6300

16921 2800

16921 6600

16921 2700

16921 6500

16921 2400

16921 6400

Iva esclusa  
Vat excluded

Euro €

275,00

275,00

315,00

315,00

325,00

325,00

320,00

320,00

Net weight/Peso netto: 1.9 kg

Pack/Colli: 2

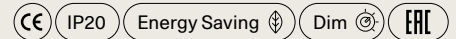

Suspension lamps must be installed on a canopy ► pag. 040-049  
Le lampade a sospensione devono essere installate su rosone ► pag. 040-049

### JIM cone

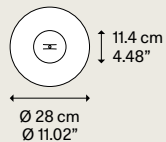
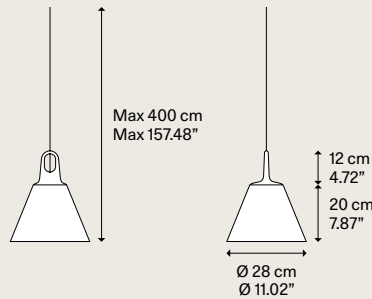

Light source  
Sorgente luminosa

E27 A60 LED  
1 x 25 W

Bulb not included  
Lampadina non inclusa

Outside metal diffuser  
Diff. esterno in metallo

Matte White-9010  
Bianco Opaco-9010

Matte Black-9005  
Nero Opaco-9005

Matte Champagne  
Champagne Opaco

Coppery Bronze  
Bronzo Ramato

Inside metal diffuser  
Diff. interno in metallo

Matte White-9010  
Bianco Opaco-9010

Matte White-9010  
Bianco Opaco-9010

Matte White-9010  
Bianco Opaco-9010

Matte White-9010  
Bianco Opaco-9010

Hook  
Gancio

Grey  
Grigio

Honey  
Miele

Grey  
Grigio

Honey  
Miele

Grey  
Grigio

Honey  
Miele

Grey  
Grigio

Honey  
Miele

Hook  
methacrylate  
Gancio in  
metacrilato

Code  
Codice

16922 2300

16922 6300

16922 2800

16922 6600

16922 2700

16922 6500

16922 2400

16922 6400

Iva esclusa  
Vat excluded

Euro €

230,00

230,00

270,00

270,00

280,00

280,00

275,00

275,00

Net weight/Peso netto: 1 kg

Pack/Colli: 2

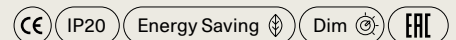

Suspension lamps must be installed on a canopy ► pag. 040-049  
Le lampade a sospensione devono essere installate su rosone ► pag. 040-049

# JIM, design by Patrick Norguet, 2021

Cluster suspension lamp

## JIM cylinder

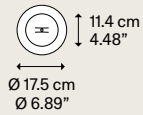
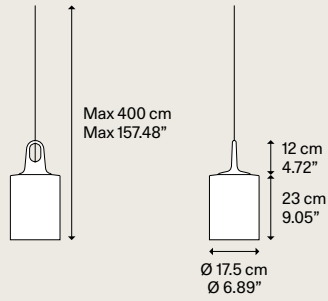

Light source  
Sorgente luminosa

Outside metal diffuser  
Diff. esterno in metallo

Inside metal diffuser  
Diff. interno in metallo

Hook  
Gancio

Code  
Codice

Iva esclusa  
Vat excluded  
Euro €

E27 A60 LED  
1 x 25 W

Bulb not included  
Lampadina non inclusa

Hook  
methacrylate  
Gancio in  
metacrilato

Matte White-9010  
Bianco Opaco-9010

Matte White-9010  
Bianco Opaco-9010

Grey  
Grigio

16923 2300 245,00

Matte Black-9005  
Nero Opaco-9005

Matte White-9010  
Bianco Opaco-9010

Honey  
Miele

16923 6300 245,00

Matte Champagne  
Champagne Opaco

Matte White-9010  
Bianco Opaco-9010

Grey  
Grigio

16923 2800 285,00

Honey  
Miele

16923 6600 285,00

Grey  
Grigio

16923 2700 295,00

Honey  
Miele

16923 6500 295,00

Copperty Bronze  
Bronzo Ramato

Matte White-9010  
Bianco Opaco-9010

Grey  
Grigio

16923 2400 290,00

Honey  
Miele

16923 6400 290,00

Net weight/Peso netto: 1.4 kg

Pack/Colli: 2

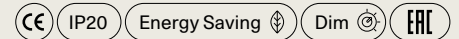

Suspension lamps must be installed on a canopy ► pag. 040-049  
Le lampade a sospensione devono essere installate su rosone ► pag. 040-049

Example of composition

14 Lights Round

R04L14 1000

3 x 16921 6500

5 x 16922 6600

6 x 16923 6500

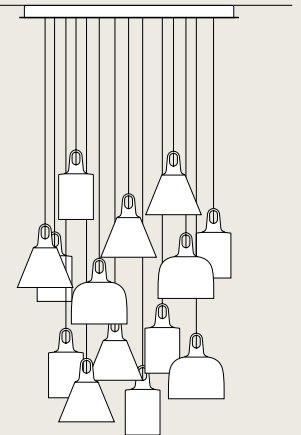
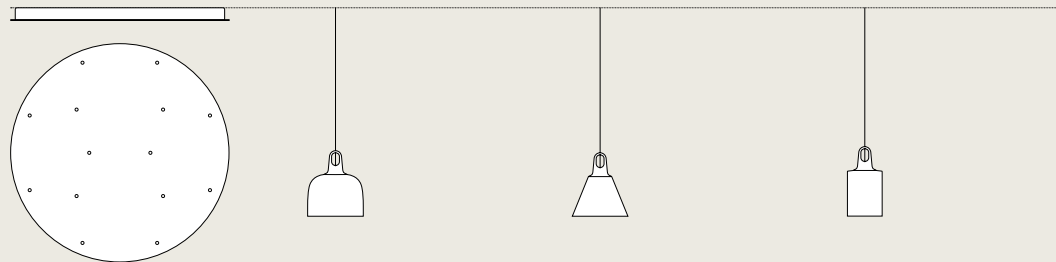

# Kelly Cluster, *design by* Andrea Tosetto, 2015

Cluster suspension lamp

## Kelly Cluster

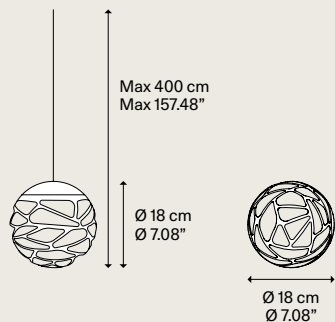

### Light source Sorgente luminosa

LED  
 ↗ 2700 K  
 ↗ 7 W/ 1280 lm  
 ↗ 350 mA  
 ↗ CRI 90  
 ↗ MacAdam 3-Step

LED and driver included  
 LED e driver inclusi

### Metal structure Montatura in metallo

- Matte White - 9010  
Bianco Opaco - 9010
- Matte Black - 9005  
Nero Opaco - 9005
- Coppery Bronze  
Bronzo Ramato
- Matte Champagne  
Champagne Opaco

### Glass diffuser Diffusore in vetro

- Glossy White  
Bianco Lucido

### Code Codice

14711 1027	375,00
14711 2027	375,00
14711 3527	390,00
14711 4527	390,00

Iva esclusa  
 Vat excluded  
**Euro €**

Net weight/Peso netto: 1 kg

Pack/ Colli: 1

Energy class/Classe energetica: C

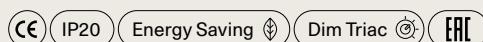

Suspension lamps must be installed on a canopy ▶ pag. 040-049  
 Le lampade a sospensione devono essere installate su rosone ▶ pag. 040-049

Ecodesign regulation ▶ pag. 084-085  
 Regolamento di Ecodesign ▶ pag. 084-085

Example of composition

3 Lights Round

R04L03 1000

1 × 14711 2027

1 × 14711 3527

1 × 14711 4527

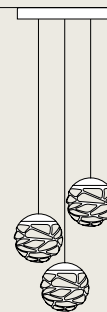
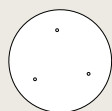

Example of composition

Short Lights Track

R08L07 1000

5 × 14711 4527

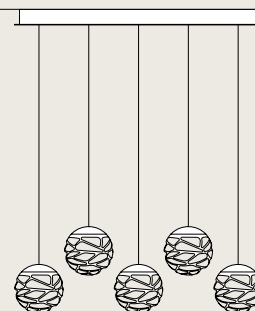
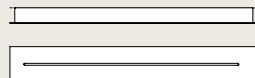

# Nostalgia, design by Dima Loginoff, 2015

Cluster suspension lamp

## Nostalgia small



Light source Sorgente luminosa	Metal structure Montatura in metallo	Blown glass diffuser Diffusore in vetro soffiato	Code Codice	Iva esclusa Vat excluded Euro €
LED ↘ 2700 K ↘ 7 W/ 1280 lm ↘ 350 mA ↘ CRI 90 ↘ MacAdam 3-Step	Chrome Cromo	Clear Trasparente	15412 0027	295,00
		Chrome Cromo	15412 4027	370,00
		Glossy Smoke Fumo Lucido	15412 4327	370,00
		Glossy Bronze Bronzo Lucido	15412 4627	370,00
		Gold Oro	15412 5027	370,00
	Transparent cable Cavo Trasparente	Rose Gold Oro Rosa	15412 5527	370,00
		Clear Trasparente	15415 0027	295,00
		Chrome Cromo	15415 4027	370,00
		Glossy Smoke Fumo Lucido	15415 4327	370,00
		Glossy Bronze Bronzo Lucido	15415 4627	370,00
Black cable Cavo Nero	Gold Oro	15415 5027	370,00	
	Rose Gold Oro Rosa	15415 5527	370,00	
LED and driver included LED e driver inclusi				

Net weight/Peso netto: 0.66 kg    Pack/Collì: 2    Energy class/Classe energetica: C

CE IP20 Energy Saving Dim Triac EAC

Suspension lamps must be installed on a canopy ▶ pag. 040-049  
Le lampade a sospensione devono essere installate su rosone ▶ pag. 040-049

Ecodesign regulation ▶ pag. 084-085  
Regolamento di Ecodesign ▶ pag. 084-085

# Nostalgia, design by Dima Loginoff, 2015

Cluster suspension lamp

## Nostalgia medium

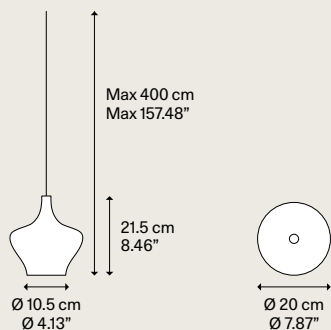

**Light source**  
Sorgente luminosa

**Metal structure**  
Montatura in metallo

**Blown glass diffuser**  
Diffusore in vetro soffiato

**Code**  
Codice

Iva esclusa  
Vat excluded  
**Euro €**

LED  
 ↘ 2700 K  
 ↘ 7 W/1280 lm  
 ↘ 350 mA  
 ↘ CRI 90  
 ↘ MacAdam 3-Step

Transparent cable  
Cavo Trasparente

Matte Black - 9005 NEW  
Nero Opaco - 9005

Black cable  
Cavo Nero

LED and driver included  
LED e driver inclusi

	Clear Trasparente	15413 0027	360,00
	Chrome Cromo	15413 4027	400,00
	Glossy Smoke Fumo Lucido	15413 4327	400,00
	Glossy Bronze Bronzo Lucido	15413 4627	400,00
	Gold Oro	15413 5027	400,00
	Rose Gold Oro Rosa	15413 5527	400,00
	Clear Trasparente	15416 0027	360,00
	Chrome Cromo	15416 4027	400,00
	Glossy Smoke Fumo Lucido	15416 4327	400,00
	Glossy Bronze Bronzo Lucido	15416 4627	400,00
	Gold Oro	15416 5027	400,00
	Rose Gold Oro Rosa	15416 5527	400,00

Net weight/Peso netto: 0.75 kg

Pack/Colli: 2

Energy class/Classe energetica: C

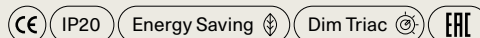

Suspension lamps must be installed on a canopy ▶ pag. 040-049  
Le lampade a sospensione devono essere installate su rosone ▶ pag. 040-049

Ecodesign regulation ▶ pag. 084-085  
Regolamento di Ecodesign ▶ pag. 084-085

# Nostalgia, design by Dima Loginoff, 2015

Cluster suspension lamp

## Nostalgia large

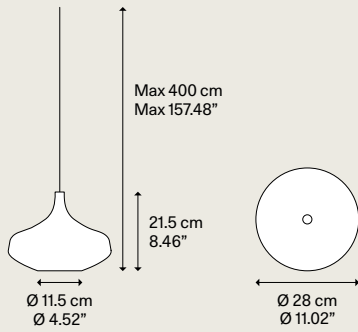

**Light source**  
Sorgente luminosa

**Metal structure**  
Montatura in metallo

**Blown glass diffuser**  
Diffusore in vetro soffiato

**Code**  
Codice

Iva esclusa  
Vat excluded  
**Euro €**

**LED**  
 ▸ 2700 K  
 ▸ 7 W/ 1280 lm  
 ▸ 350 mA  
 ▸ CRI 90  
 ▸ MacAdam 3-Step

Transparent cable  
Cavo Trasparente

Matte Black - 9005 **NEW**  
Nero Opaco - 9005

Black cable  
Cavo Nero

LED and driver included  
LED e driver inclusi

	Clear Trasparente	15414 0027	420,00
	Chrome Cromo	15414 4027	485,00
	Glossy Smoke Fumo Lucido	15414 4327	485,00
	Glossy Bronze Bronzo Lucido	15414 4627	485,00
	Gold Oro	15414 5027	485,00
	Rose Gold Oro Rosa	15414 5527	485,00
	Clear Trasparente	15417 0027	420,00
	Chrome Cromo	15417 4027	485,00
	Glossy Smoke Fumo Lucido	15417 4327	485,00
	Glossy Bronze Bronzo Lucido	15417 4627	485,00
	Gold Oro	15417 5027	485,00
	Rose Gold Oro Rosa	15417 5527	485,00

Net weight/Peso netto: 1.02 kg

Pack/Colli: 2

Energy class/Classe energetica: C



IP20

Energy Saving

Dim Triac



Suspension lamps must be installed on a canopy ▶ pag. 040-049  
Le lampade a sospensione devono essere installate su rosone ▶ pag. 040-049

Ecodesign regulation ▶ pag. 084-085  
Regolamento di Ecodesign ▶ pag. 084-085

Example of composition

14 Lights Round

R04L14 1000

6 × 15412 0027

5 × 15413 4327

3 × 15414 4627

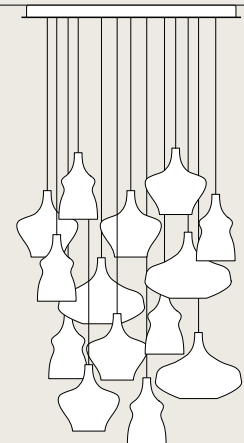
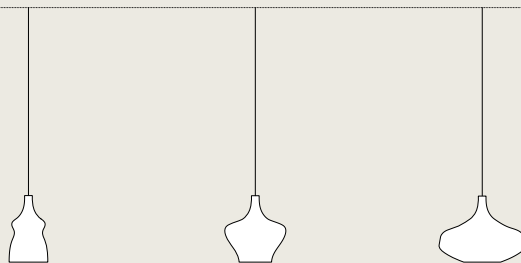
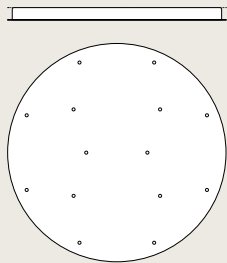

# Rain, design by Andrea Tosetto, 2015

Cluster suspension lamp

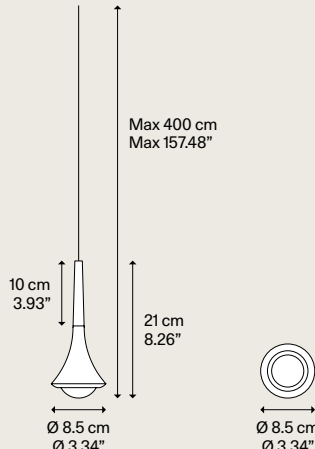
Rain	Light source Sorgente luminosa	Metal structure Montatura in metallo	Metal decor Decoro in metallo	Code Codice	Iva esclusa Vat excluded Euro €	
	LED ▷ 2700 K ▷ 7 W/ 1280 lm ▷ 350 mA ▷ CRI 90 ▷ MacAdam 3-Step	Chrome Cromo	Matte Black - 9005 Nero Opaco - 9005	15611 2027	175,00	
			Coppery Bronze Bronzo Ramato	15611 3527	180,00	
			Brushed Chrome Cromo Spazzolato	15611 4727	190,00	
			Gold Oro	15611 5027	190,00	
			Rose Gold Oro Rosa	15611 5527	190,00	
			Matte Black - 9005 Nero Opaco - 9005	15612 2027	175,00	
	LED ▷ 3000 K ▷ 7 W/ 1300 lm ▷ 350 mA ▷ CRI 90 ▷ MacAdam 3-Step	Matte Black - 9005 Nero Opaco - 9005	Chrome Cromo	Coppery Bronze Bronzo Ramato	15612 3527	180,00
				Brushed Chrome Cromo Spazzolato	15612 4727	190,00
				Gold Oro	15612 5027	190,00
				Rose Gold Oro Rosa	15612 5527	190,00
				Matte Black - 9005 Nero Opaco - 9005	15611 2030	175,00
				Coppery Bronze Bronzo Ramato	15611 3530	180,00
LED ▷ 3000 K ▷ 7 W/ 1300 lm ▷ 350 mA ▷ CRI 90 ▷ MacAdam 3-Step	Chrome Cromo	Brushed Chrome Cromo Spazzolato	Gold Oro	15611 4730	190,00	
			Rose Gold Oro Rosa	15611 5530	190,00	
			Matte Black - 9005 Nero Opaco - 9005	15612 2030	175,00	
			Coppery Bronze Bronzo Ramato	15612 3530	180,00	
			Brushed Chrome Cromo Spazzolato	15612 4730	190,00	
			Gold Oro	15612 5030	190,00	
LED and driver included LED e driver inclusi	Black cable Cavo Nero	Matte Black - 9005 Nero Opaco - 9005	Rose Gold Oro Rosa	15612 5530	190,00	
			Rose Gold Oro Rosa	15612 5530	190,00	

Net weight/Peso netto: 0.34 kg

Pack/Colli: 2

Energy class/Classe energetica: C

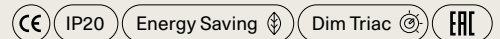

Suspension lamps must be installed on a canopy ► pag. 040-049  
 Le lampade a sospensione devono essere installate su rosone ► pag. 040-049

Ecodesign regulation ► pag. 084-085  
 Regolamento di Ecodesign ► pag. 084-085



# Rain, *design by* Andrea Tosetto, 2015

Example of composition

Short Lights Track

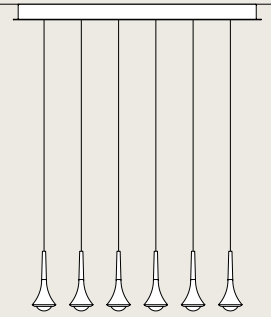
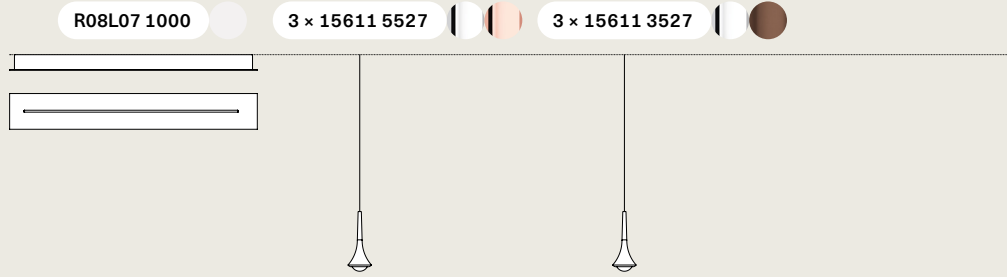

Example of composition

7 Lights Round

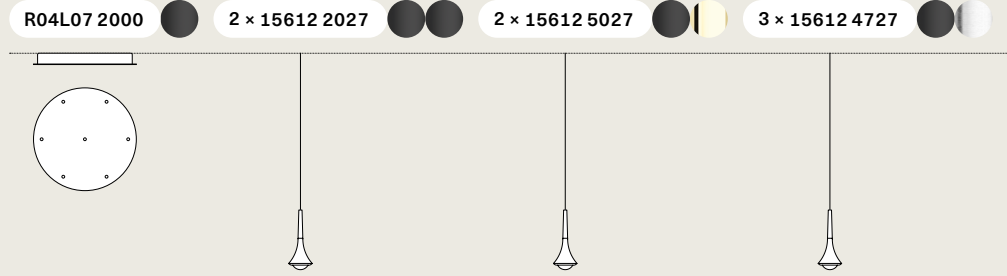

Example of composition

5-12 Lights Radial

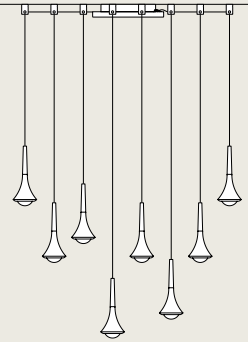
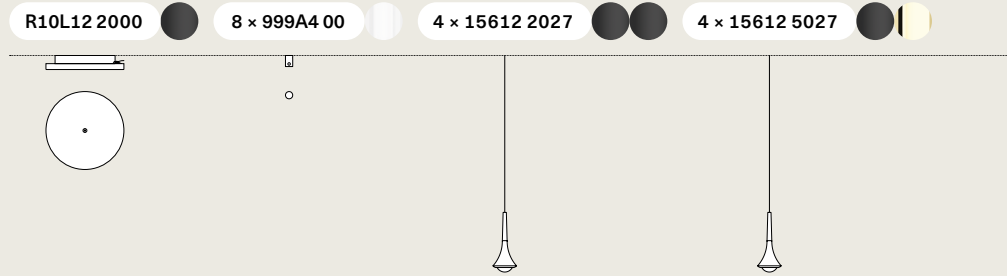

Suspension lamp

Cluster suspension lamp

Canopy

Wall & Ceiling lamp

Floor & Table lamp

Outdoor lamp

Accessory

# Random, design by Chia-Ying Lee, 2017

## Cluster suspension lamp

### Random

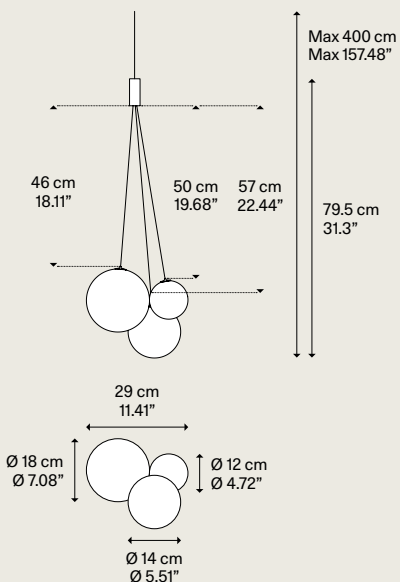

**Light source**  
Sorgente luminosa

**Metal structure**  
Montatura in metallo

**Blown glass diffuser**  
Diffusore in vetro soffiato

**Code**  
Codice

Iva esclusa  
Vat excluded

**Euro €**

LED  
 ↘ 2700 K  
 ↘ 3 × 1 W / 450 lm  
 ↘ 350 mA  
 ↘ CRI 90  
 ↘ MacAdam 3-Step

Chrome  
Cromo

or

LED  
 ↘ 3000 K  
 ↘ 3 × 1 W / 480 lm  
 ↘ 350 mA  
 ↘ CRI 90  
 ↘ MacAdam 3-Step

Chrome  
Cromo

	Clear Trasparente	16410 0027	260,00
	Frosted White Bianco Satinato	16410 1327	370,00
	Chrome Cromo	16410 4027	370,00
	Glossy Smoke Fumo Lucido	16410 4327	370,00
	Glossy Bronze <b>NEW</b> Bronzo Lucido	16410 4627	370,00
	Gold Oro	16410 5027	370,00
	Rose Gold Oro Rosa	16410 5527	370,00
	Clear Trasparente	16410 0030	260,00
	Frosted White Bianco Satinato	16410 1330	370,00
	Chrome Cromo	16410 4030	370,00
	Glossy Smoke Fumo Lucido	16410 4330	370,00
	Glossy Bronze <b>NEW</b> Bronzo Lucido	16410 4630	370,00
	Gold Oro	16410 5030	370,00
	Rose Gold Oro Rosa	16410 5530	370,00

LED and driver included  
LED e driver inclusi

Net weight/Peso netto: 1.0 kg

Pack/Colli: 2

Energy class/Classe energetica: D

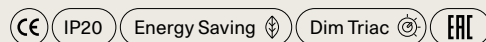

Suspension lamps must be installed on a canopy ▶ pag. 040-049  
Le lampade a sospensione devono essere installate su rosone ▶ pag. 040-049

Ecodesign regulation ▶ pag. 084-085  
Regolamento di Ecodesign ▶ pag. 084-085

Example of composition

5-12 Lights Radial

R10L12 1000

8 × 999A4 00

4 × 16410 0027

4 × 16410 4627

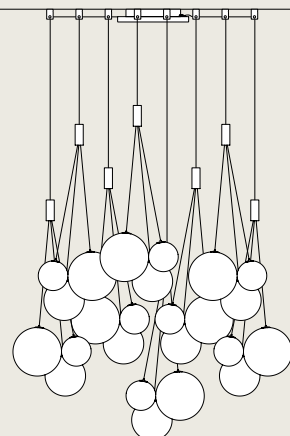
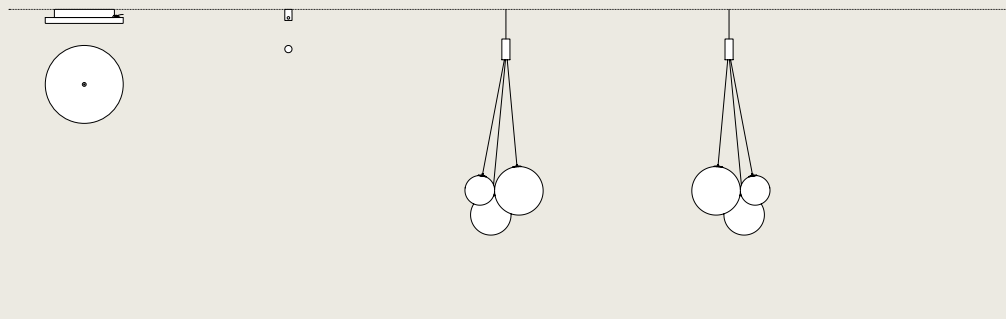

# Random Solo, design by Chia-Ying Lee, 2020

Cluster suspension lamp

## Random Solo 12

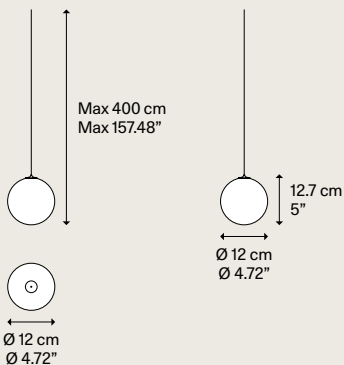

Light source Sorgente luminosa	Blown glass diffuser Diffusore in vetro soffiato	Code Codice	Iva esclusa Vat excluded Euro €
LED ↘ 2700 K ↘ 1 W / 150 lm ↘ 350 mA ↘ CRI 90 ↘ MacAdam 3-Step	Clear Trasparente	17111 0027	120,00
	Frosted White Bianco Satinato	17111 1327	145,00
	Chrome Cromo	17111 4027	145,00
	Glossy Smoke Fumo Lucido	17111 4327	145,00
	Glossy Bronze <sup>NEW</sup> Bronzo Lucido	17111 4627	145,00
	Gold Oro	17111 5027	145,00
	Rose Gold Oro Rosa	17111 5527	145,00
	Clear Trasparente	17111 0030	120,00
	Frosted White Bianco Satinato	17111 1330	145,00
	Chrome Cromo	17111 4030	145,00
LED ↘ 3000 K ↘ 1 W / 160 lm ↘ 350 mA ↘ CRI 90 ↘ MacAdam 3-Step	Glossy Smoke Fumo Lucido	17111 4330	145,00
	Glossy Bronze <sup>NEW</sup> Bronzo Lucido	17111 4630	145,00
	Gold Oro	17111 5030	145,00
	Rose Gold Oro Rosa	17111 5530	145,00

LED and driver included  
LED e driver inclusi

Net weight / Peso netto: 0.25 kg

Pack / Colli: 2

Energy class / Classe energetica: D



IP20

Energy Saving

Dim Triac



Suspension lamps must be installed on a canopy ▶ pag. 040-049  
Le lampade a sospensione devono essere installate su rosone ▶ pag. 040-049

Ecodesign regulation ▶ pag. 084-085  
Regolamento di Ecodesign ▶ pag. 084-085

# Random Solo, design by Chia-Ying Lee, 2020

Cluster suspension lamp

## Random Solo 14

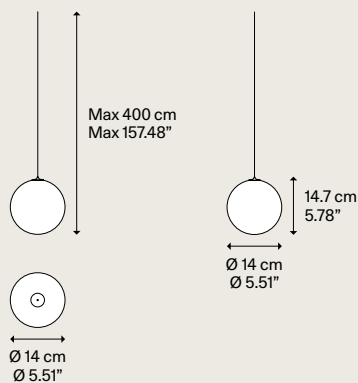

Light source  
Sorgente luminosa

Blown glass diffuser  
Diffusore in vetro soffiato

Iva esclusa  
Vat excluded  
Code  
Codice Euro €

LED  
↘ 2700 K  
↘ 1 W / 150 lm  
↘ 350 mA  
↘ CRI 90  
↘ MacAdam 3-Step

	Clear Trasparente	17112 0027	125,00
	Frosted White Bianco Satinato	17112 1327	155,00
	Chrome Cromo	17112 4027	155,00
	Glossy Smoke Fumo Lucido	17112 4327	155,00
	Glossy Bronze <sup>NEW</sup> Bronzo Lucido	17112 4627	155,00
	Gold Oro	17112 5027	155,00
	Rose Gold Oro Rosa	17112 5527	155,00

or

LED  
↘ 3000 K  
↘ 1 W / 160 lm  
↘ 350 mA  
↘ CRI 90  
↘ MacAdam 3-Step

	Clear Trasparente	17112 0030	125,00
	Frosted White Bianco Satinato	17112 1330	155,00
	Chrome Cromo	17112 4030	155,00
	Glossy Smoke Fumo Lucido	17112 4330	155,00
	Glossy Bronze <sup>NEW</sup> Bronzo Lucido	17112 4630	155,00
	Gold Oro	17112 5030	155,00
	Rose Gold Oro Rosa	17112 5530	155,00

LED and driver included  
LED e driver inclusi

Net weight / Peso netto: 0.32 kg

Pack / Colli: 2

Energy class / Classe energetica: D

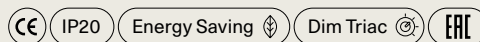

Suspension lamps must be installed on a canopy ▶ pag. 040-049  
Le lampade a sospensione devono essere installate su rosone ▶ pag. 040-049

Ecodesign regulation ▶ pag. 084-085  
Regolamento di Ecodesign ▶ pag. 084-085

# Random Solo, design by Chia-Ying Lee, 2020

Cluster suspension lamp

## Random Solo 18

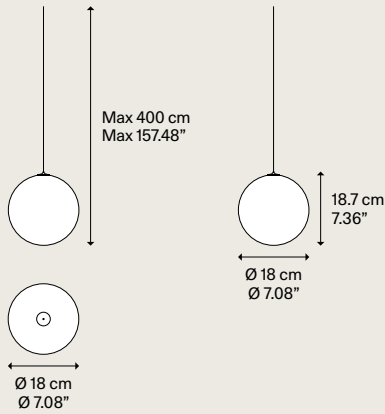

Light source Sorgente luminosa	Blown glass diffuser Diffusore in vetro soffiato	Code Codice	Iva esclusa Vat excluded Euro €	
LED ↘ 2700 K ↘ 1 W / 150 lm ↘ 350 mA ↘ CRI 90 ↘ MacAdam 3-Step	Clear Trasparente	17113 0027	140,00	
	Frosted White Bianco Satinato	17113 1327	170,00	
	Chrome Cromo	17113 4027	170,00	
	Glossy Smoke Fumo Lucido	17113 4327	170,00	
	Glossy Bronze <sup>NEW</sup> Bronzo Lucido	17113 4627	170,00	
	Gold Oro	17113 5027	170,00	
	Rose Gold Oro Rosa	17113 5527	170,00	
	or	Clear Trasparente	17113 0030	140,00
		Frosted White Bianco Satinato	17113 1330	170,00
		Chrome Cromo	17113 4030	170,00
Glossy Smoke Fumo Lucido		17113 4330	170,00	
Glossy Bronze <sup>NEW</sup> Bronzo Lucido		17113 4630	170,00	
Gold Oro		17113 5030	170,00	
	Rose Gold Oro Rosa	17113 5530	170,00	

LED and driver included  
LED e driver inclusi

Net weight / Peso netto: 0.8 kg

Pack / Colli: 2

Energy class / Classe energetica: D



IP20

Energy Saving

Dim Triac



Suspension lamps must be installed on a canopy ▶ pag. 040-049  
Le lampade a sospensione devono essere installate su rosone ▶ pag. 040-049

Ecodesign regulation ▶ pag. 084-085  
Regolamento di Ecodesign ▶ pag. 084-085

# Random Solo, design by Chia-Ying Lee, 2020

Cluster suspension lamp

## Random Solo 23

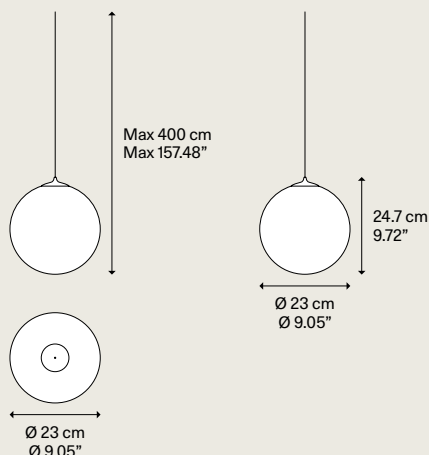

Light source  
Sorgente luminosa

Blown glass diffuser  
Diffusore in vetro soffiato

Iva esclusa  
Vat excluded  
Code  
Codice Euro €

LED  
 ↗ 2700 K  
 ↗ 3 W / 450 lm  
 ↗ 350 mA  
 ↗ CRI 90  
 ↗ MacAdam 3-Step

	Clear Trasparente	17114 0027	230,00
	Frosted White Bianco Satinato	17114 1327	350,00
	Chrome Cromo	17114 4027	350,00
	Glossy Smoke Fumo Lucido	17114 4327	350,00
	Glossy Bronze <sup>NEW</sup> Bronzo Lucido	17114 4627	350,00
	Gold Oro	17114 5027	350,00
	Rose Gold Oro Rosa	17114 5527	350,00

or

LED  
 ↗ 3000 K  
 ↗ 3 W / 480 lm  
 ↗ 350 mA  
 ↗ CRI 90  
 ↗ MacAdam 3-Step

	Clear Trasparente	17114 0030	230,00
	Frosted White Bianco Satinato	17114 1330	350,00
	Chrome Cromo	17114 4030	350,00
	Glossy Smoke Fumo Lucido	17114 4330	350,00
	Glossy Bronze <sup>NEW</sup> Bronzo Lucido	17114 4630	350,00
	Gold Oro	17114 5030	350,00
	Rose Gold Oro Rosa	17114 5530	350,00

LED and driver included  
LED e driver inclusi

Net weight / Peso netto: 1.1 kg

Pack / Colli: 2

Energy class / Classe energetica: D

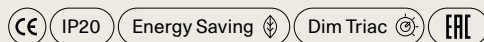

Suspension lamps must be installed on a canopy ▶ pag. 040-049  
Le lampade a sospensione devono essere installate su rosone ▶ pag. 040-049

Ecodesign regulation ▶ pag. 084-085  
Regolamento di Ecodesign ▶ pag. 084-085

# Random Solo, design by Chia-Ying Lee, 2020

Cluster suspension lamp

## Random Solo 28

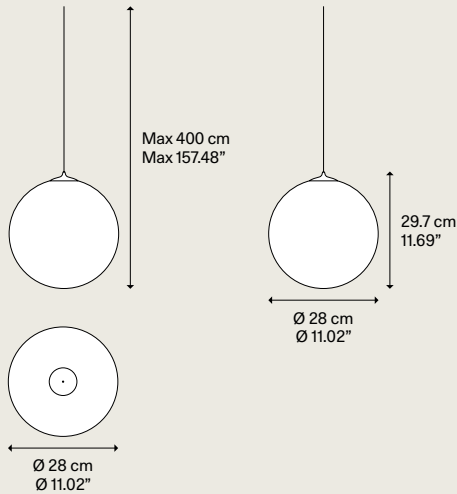

Light source  
Sorgente luminosa

Blown glass diffuser  
Diffusore in vetro soffiato

Iva esclusa  
Vat excluded  
Code  
Codice Euro €

LED  
 ↘ 2700 K  
 ↘ 3 W / 450 lm  
 ↘ 350 mA  
 ↘ CRI 90  
 ↘ MacAdam 3-Step

or

LED  
 ↘ 3000 K  
 ↘ 3 W / 480 lm  
 ↘ 350 mA  
 ↘ CRI 90  
 ↘ MacAdam 3-Step

LED and driver included  
LED e driver inclusi

	Clear Trasparente	17115 0027	270,00
	Frosted White Bianco Satinato	17115 1327	390,00
	Chrome Cromo	17115 4027	390,00
	Glossy Smoke Fumo Lucido	17115 4327	390,00
	Glossy Bronze <b>NEW</b> Bronzo Lucido	17115 4627	390,00
	Gold Oro	17115 5027	390,00
	Rose Gold Oro Rosa	17115 5527	390,00
	Clear Trasparente	17115 0030	270,00
	Frosted White Bianco Satinato	17115 1330	390,00
	Chrome Cromo	17115 4030	390,00
	Glossy Smoke Fumo Lucido	17115 4330	390,00
	Glossy Bronze <b>NEW</b> Bronzo Lucido	17115 4630	390,00
	Gold Oro	17115 5030	390,00
	Rose Gold Oro Rosa	17115 5530	390,00

Net weight / Peso netto: 1.8 kg

Pack / Colli: 2

Energy class / Classe energetica: D



IP20

Energy Saving

Dim Triac



Suspension lamps must be installed on a canopy ▶ pag. 040-049  
Le lampade a sospensione devono essere installate su rosone ▶ pag. 040-049

Ecodesign regulation ▶ pag. 084-085  
Regolamento di Ecodesign ▶ pag. 084-085

Example of composition

7 Lights Rectangular

R05L07 1000

3 × 17111 0027

2 × 17112 1327

2 × 17114 4327

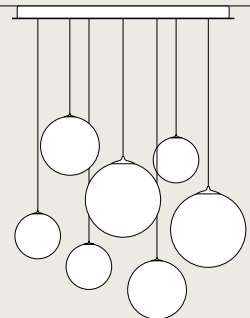
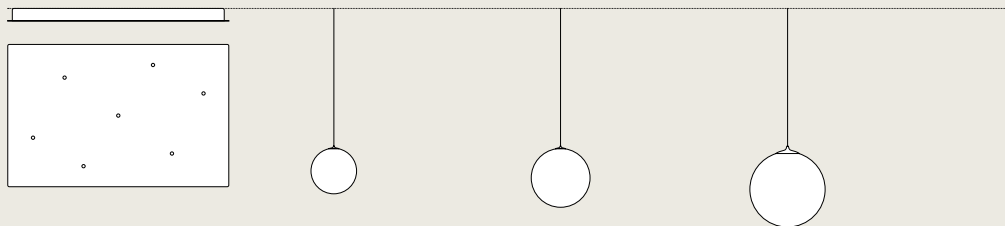

# Spider, design by Andrea Tosetto, 2015

Cluster suspension lamp

## Spider

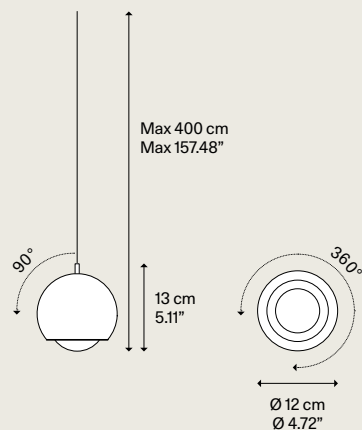

**Light source**  
Sorgente luminosa

**Metal structure**  
Montatura in metallo

**Metal diffuser**  
Diffusore in metallo

**Code**  
Codice

Iva esclusa  
Vat excluded  
**Euro €**

LED  
 ↗ 2700 K  
 ↗ 7 W / 1280 lm  
 ↗ 350 mA  
 ↗ CRI 90  
 ↗ MacAdam 3-Step

Chrome  
Cromo

or

LED  
 ↗ 3000 K  
 ↗ 7 W / 1300 lm  
 ↗ 350 mA  
 ↗ CRI 90  
 ↗ MacAdam 3-Step

Chrome  
Cromo

LED and driver included  
LED e driver inclusi

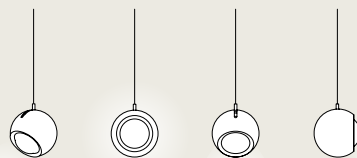

Matte White - 9010 Bianco Opaco - 9010	16010 1027	250,00
Matte Black - 9005 Nero Opaco - 9005	16010 2027	250,00
Chrome Cromo	16010 4027	265,00
Matte Champagne Champagne Opaco	16010 4527	265,00
Gold Oro	16010 5027	275,00
Rose Gold Oro Rosa	16010 5527	275,00
Terra Terra	16010 6727	275,00
Matte White - 9010 Bianco Opaco - 9010	16010 1030	250,00
Matte Black - 9005 Nero Opaco - 9005	16010 2030	250,00
Chrome Cromo	16010 4030	265,00
Matte Champagne Champagne Opaco	16010 4530	265,00
Gold Oro	16010 5030	275,00
Rose Gold Oro Rosa	16010 5530	275,00
Terra Terra	16010 6730	275,00

**Adjustable light**  
Luce orientabile

Net weight/Peso netto: 0.8 kg

Pack/Colli: 2

Energy class/Classe energetica: C



IP20

Energy Saving

Dim Triac



Suspension lamps must be installed on a canopy ▶ pag. 040-049  
Le lampade a sospensione devono essere installate su rosone ▶ pag. 040-049

Ecodesign regulation ▶ pag. 084-085  
Regolamento di Ecodesign ▶ pag. 084-085



# Volum, design by Snøhetta, 2022

## Cluster suspension lamp

### Volum 14

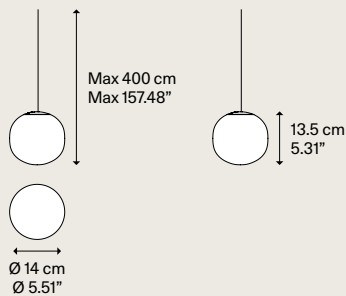

Net weight/Peso netto: 0.90 kg Pack/Colli: 2

**Light source**  
Sorgente luminosa

E14 LED  
1 × 15 W  
Ø max 6 cm – 2.36"

W/L max 8 cm  
W/L max 3.14"

Bulb not included  
Lampadina non inclusa

**Methacrylate structure**  
Struttura in metacrilato

Glossy White  
Bianco Lucido

**Blown glass diffuser**  
Diffusore in vetro soffiato

Glossy White  
Bianco Lucido

**Code**  
Codice

18711 1200

Iva esclusa

Vat excluded

**Euro €**

165,00

CE IP20 Energy Saving Dim Triac EAC

### Volum 22

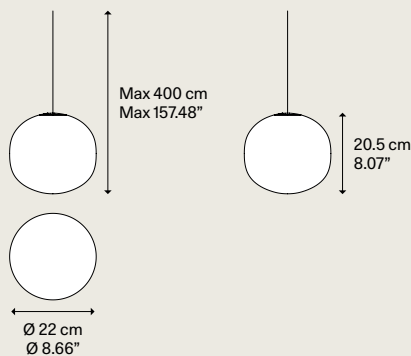

Net weight/Peso netto: 1.50 kg Pack/Colli: 2

**Light source**  
Sorgente luminosa

E27 LED  
1 × 25 W  
Ø max 6 cm – 2.36"

W/L max 11 cm  
W/L max 4.33"

Bulb not included  
Lampadina non inclusa

**Methacrylate structure**  
Struttura in metacrilato

Glossy White  
Bianco Lucido

**Blown glass diffuser**  
Diffusore in vetro soffiato

Glossy White  
Bianco Lucido

**Code**  
Codice

18712 1200

Iva esclusa

Vat excluded

**Euro €**

255,00

CE IP20 Energy Saving Dim Triac EAC

### Volum 29

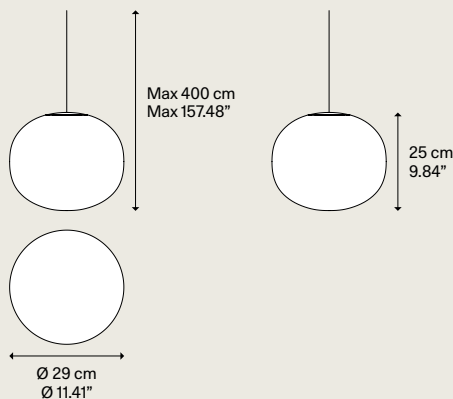

Net weight/Peso netto: 2.20 kg Pack/Colli: 2

**Light source**  
Sorgente luminosa

E27 LED  
1 × 25 W  
Ø max 9.8 cm  
Ø max 3.74"

Bulb not included  
Lampadina non inclusa

**Methacrylate structure**  
Struttura in metacrilato

Glossy White  
Bianco Lucido

**Blown glass diffuser**  
Diffusore in vetro soffiato

Glossy White  
Bianco Lucido

**Code**  
Codice

18713 1200

Iva esclusa

Vat excluded

**Euro €**

320,00

CE IP20 Energy Saving Dim Triac EAC

Suspension lamps must be installed on a canopy ► pag. 040–049  
Le lampade a sospensione devono essere installate su rosone ► pag. 040–049

Suspension lamp  
Cluster suspension lamp  
Canopy  
Wall & Ceiling lamp  
Floor & Table lamp  
Outdoor lamp  
Accessory

# Lodes' Canopy Systems

## Single Systems

---



Single Mini  
Pag. 041

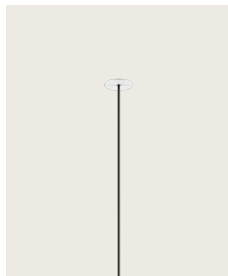

Recessed Micro  
Pag. 041



Single Standard  
Pag. 042



Wall Standard  
Pag. 042

## Multiple Systems

---



Round  
Pag. 043, 044

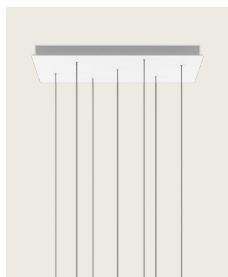

Rectangular  
Pag. 045

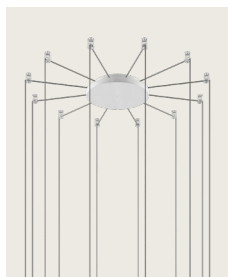

Radial  
Pag. 046, 047

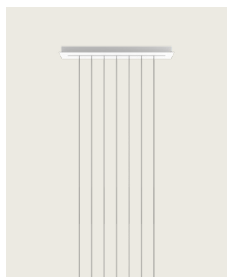

Track  
Pag. 048, 049

Single Canopy

## Single Mini

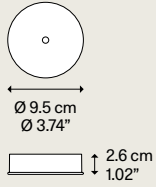

Description Descrizione	Methacrylate structure Struttura in metacrilato	System Sistema	Code Codice	Iva esclusa Vat excluded Euro €
Single ceiling bracket small size	Matte White – 9010 Bianco Opaco – 9010	Single	R11L01 1000	42,00
Rosone per lampada singola versione mini	Matte Black – 9005 Nero Opaco – 9005		R11L01 2000	42,00
	Coppery Bronze Bronzo Ramato		R11L01 3500	46,00
	Chrome Cromo		R11L01 4000	50,00
	Matte Champagne Champagne Opaco		R11L01 4500	48,00

Net weight / Peso netto: 0.13 kg

Pack / Colli: 1

CE IP20

Recessed Canopy

## Recessed Micro

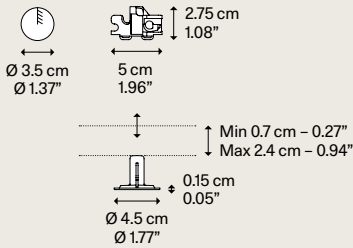

Description Descrizione	Methacrylate structure Struttura in metacrilato	System Sistema	Code Codice	Iva esclusa Vat excluded Euro €
Recessed bracket for single lamp max capacity 3.5 kg	Matte White – 9010 Bianco Opaco – 9010	Recessed	R01L01 1000	25,00
Rosone da incasso per lampada singola portata max 3.5 kg	Matte Black – 9005 Nero Opaco – 9005		R01L01 2000	25,00
	Chrome Cromo		R01L01 4000	30,00

Net weight / Peso netto: 0.025 kg

Pack / Colli: 1

CE IP20

Suspension lamp

Cluster suspension lamp

Canopy

Wall & Ceiling lamp

Floor & Table lamp

Outdoor lamp

Accessory

Single Canopy

## Single Standard

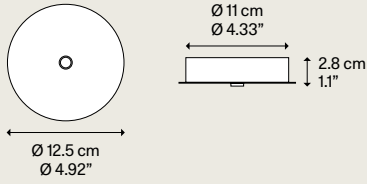

**Description**  
**Descrizione**

Single ceiling bracket standard size

Rosone per lampada singola versione standard

**Metal structure**  
**Struttura in metallo**

Matte White - 9010  
Bianco Opaco - 9010

**System**  
**Sistema**

Single

**Code**  
**Codice**

R03L01 1000

**Euro €**

60,00

Iva esclusa  
Vat excluded

Net weight/Peso netto: 0.4 kg

Pack/Colli: 1



Wall Bracket

## Wall Standard

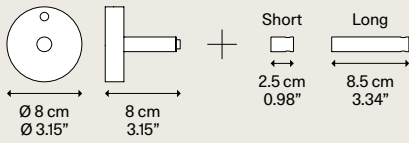

**Description**  
**Descrizione**

Wall bracket for suspension modular system

Supporto a parete per sistema modulare a sospensione

**Metal structure**  
**Struttura in metallo**

Chrome  
Cromo

**System**  
**Sistema**

Wall

**Code**  
**Codice**

R09L01 4000

**Euro €**

115,00

Iva esclusa  
Vat excluded

Net weight/Peso netto: 0.8 kg

Pack/Colli: 1



## 3 Lights Round

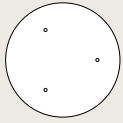

Ø 38 cm  
Ø 14.96"

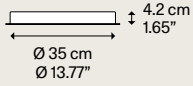

Net weight/Peso netto: 3.55 kg

Pack/Colli: 1

CE IP20

Description Descrizione	Metal structure Struttura in metallo	System Sistema	Code Codice	Iva esclusa Vat excluded Euro €
Round canopy for 3 suspensions	Matte White – 9010 Bianco Opaco – 9010	Cluster	R04L03 1000	265,00
Rosone circolare per 3 sospensioni	Matte Black – 9005 Nero Opaco – 9005		R04L03 2000	265,00

## 5 Lights Round

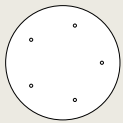

Ø 38 cm  
Ø 14.96"

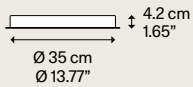

Net weight/Peso netto: 3.55 kg

Pack/Colli: 1

CE IP20

Description Descrizione	Metal structure Struttura in metallo	System Sistema	Code Codice	Iva esclusa Vat excluded Euro €
Round canopy for 5 suspensions	Matte White – 9010 Bianco Opaco – 9010	Cluster	R04L05 1000	310,00
Rosone circolare per 5 sospensioni	Matte Black – 9005 Nero Opaco – 9005		R04L05 2000	310,00

## 7 Lights Round

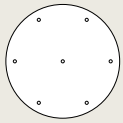

Ø 38 cm  
Ø 14.96"

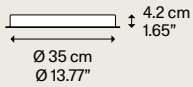

Net weight/Peso netto: 3.55 kg

Pack/Colli: 1

CE IP20

Description Descrizione	Metal structure Struttura in metallo	System Sistema	Code Codice	Iva esclusa Vat excluded Euro €
Round canopy for 7 suspensions	Matte White – 9010 Bianco Opaco – 9010	Cluster	R04L07 1000	350,00
Rosone circolare per 7 sospensioni	Matte Black – 9005 Nero Opaco – 9005		R04L07 2000	350,00

## 9 Lights Round

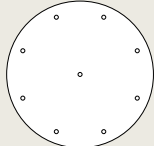

Ø 50 cm  
Ø 19.68"

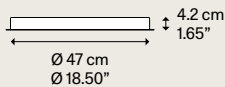

Net weight/Peso netto: 5.80 kg

Pack/Colli: 1

CE IP20

Description Descrizione	Metal structure Struttura in metallo	System Sistema	Code Codice	Iva esclusa Vat excluded Euro €
Round canopy for 9 suspensions	Matte White – 9010 Bianco Opaco – 9010	Cluster	R04L09 1000	520,00
Rosone circolare per 9 sospensioni	Matte Black – 9005 Nero Opaco – 9005		R04L09 2000	520,00

## 14 Lights Round

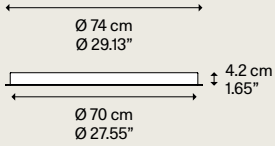
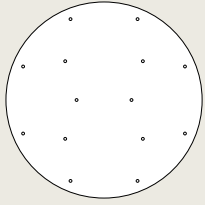

Net weight/Peso netto: 14.14 kg

Pack/Colli: 1



Description Descrizione	Metal structure Struttura in metallo	System Sistema	Code Codice	Iva esclusa Vat excluded Euro €
Round canopy for 14 suspensions	● Matte White – 9010 Bianco Opaco – 9010	Cluster	R04L14 1000	1040,00
Rosone circolare per 14 sospensioni	● Matte Black – 9005 Nero Opaco – 9005		R04L14 2000	1040,00

## 24 Lights Round

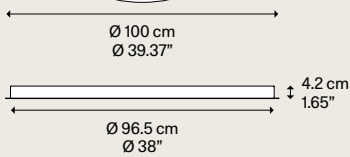
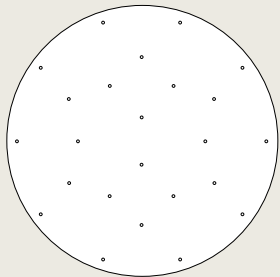

Net weight/Peso netto: 23.5 kg

Pack/Colli: 1



Description Descrizione	Metal structure Struttura in metallo	System Sistema	Code Codice	Iva esclusa Vat excluded Euro €
Round canopy for 24 suspensions	● Matte White – 9010 Bianco Opaco – 9010	Cluster	R04L24 1000	1790,00
Rosone circolare per 24 sospensioni	● Matte Black – 9005 Nero Opaco – 9005		R04L24 2000	1790,00

## 36 Lights Round

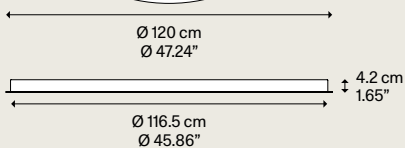
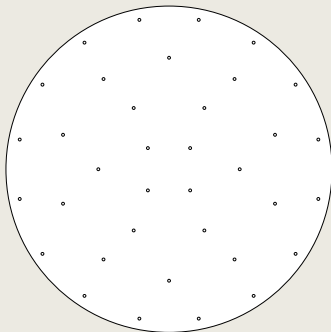

Net weight/Peso netto: 32.7 kg

Pack/Colli: 1



Description Descrizione	Metal structure Struttura in metallo	System Sistema	Code Codice	Iva esclusa Vat excluded Euro €
Round canopy for 36 suspensions	● Matte White – 9010 Bianco Opaco – 9010	Cluster	R04L36 1000	2200,00
Rosone circolare per 36 sospensioni	● Matte Black – 9005 Nero Opaco – 9005		R04L36 2000	2200,00

## 7 Lights Rectangular

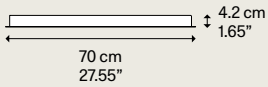
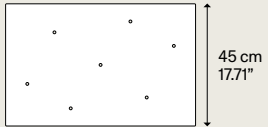

Net weight / Peso netto: 9.89 kg

Pack / Colli: 1



## 14 Lights Rectangular

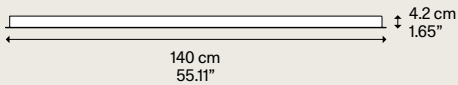
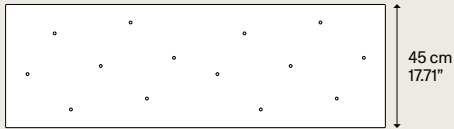

Net weight / Peso netto: 17.1 kg

Pack / Colli: 1

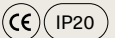

## 28 Lights Rectangular

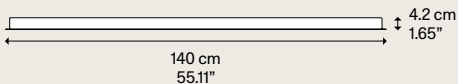
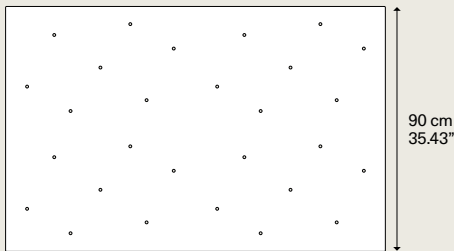

Net weight / Peso netto: 31.1 kg

Pack / Colli: 1

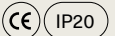
Description  
DescrizioneRectangular  
canopy for 7  
suspensionsRosone  
rettangolare per  
7 sospensioniMetal structure  
Struttura in metallo

● Matte White – 9010  
Bianco Opaco – 9010

● Matte Black – 9005  
Nero Opaco – 9005

System  
Sistema

Cluster

Code  
Codice

R05L07 1000 550,00

R05L07 2000 550,00

Iva esclusa

Vat excluded

Euro €

Description  
DescrizioneRectangular  
canopy for 14  
suspensionsRosone  
rettangolare per  
14 sospensioniMetal structure  
Struttura in metallo

● Matte White – 9010  
Bianco Opaco – 9010

● Matte Black – 9005  
Nero Opaco – 9005

System  
Sistema

Cluster

Code  
Codice

R05L14 1000 985,00

R05L14 2000 985,00

Iva esclusa

Vat excluded

Euro €

Description  
DescrizioneRectangular  
canopy for 28  
suspensionsRosone  
rettangolare per  
28 sospensioniMetal structure  
Struttura in metallo

● Matte White – 9010  
Bianco Opaco – 9010

● Matte Black – 9005  
Nero Opaco – 9005

System  
Sistema

Cluster

Code  
Codice

R05L28 1000 1750,00

R05L28 2000 1750,00

Iva esclusa

Vat excluded

Euro €

Radial System

## 1-4 Lights Radial



Ø 16.5 cm  
Ø 6.49"

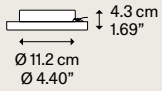

Ø 11.2 cm  
Ø 4.40"

Net weight/Peso netto: 0.35 kg

Pack/Colli: 1



Description Descrizione	Metal structure Struttura in metallo	System Sistema	Code Codice	Iva esclusa Vat excluded Euro €
Radial canopy max 4 suspension	● Matte White - 9010 Bianco Opaco - 9010	Radial	R10L04 1000	120,00
Rosone radiale max 4 sospensioni	● Matte Black - 9005 Nero Opaco - 9005		R10L04 2000	120,00
Radial Swag Kit not included				
Radial Swag Kit non incluso				

## 5-12 Lights Radial

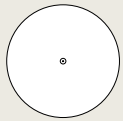

Ø 25 cm  
Ø 9.84"

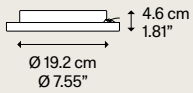

Ø 19.2 cm  
Ø 7.55"

Net weight/Peso netto: 1.05 kg

Pack/Colli: 1



Description Descrizione	Metal structure Struttura in metallo	System Sistema	Code Codice	Iva esclusa Vat excluded Euro €
Radial canopy max 12 suspension	● Matte White - 9010 Bianco Opaco - 9010	Radial	R10L12 1000	315,00
Rosone radiale max 12 sospensioni	● Matte Black - 9005 Nero Opaco - 9005		R10L12 2000	315,00
Radial Swag Kit not included				
Radial Swag Kit non incluso				

## 13-28 Lights Radial

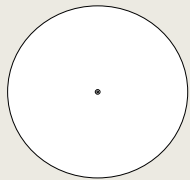

Ø 36 cm  
Ø 14.17"

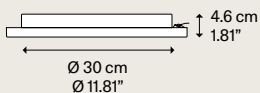

Ø 30 cm  
Ø 11.81"

Net weight/Peso netto: 3.35 kg

Pack/Colli: 1



Description Descrizione	Metal structure Struttura in metallo	System Sistema	Code Codice	Iva esclusa Vat excluded Euro €
Radial canopy max 28 suspension	● Matte White - 9010 Bianco Opaco - 9010	Radial	R10L28 1000	495,00
Rosone radiale max 28 sospensioni	● Matte Black - 9005 Nero Opaco - 9005		R10L28 2000	495,00
Radial Swag Kit not included				
Radial Swag Kit non incluso				



Radial System

# Swag Kit for Radial Canopy

Ø 2 cm  
Ø 0.78"



3 cm  
1.18"



Description Descrizione	Polycarbonate structure Struttura in policarbonato	System Sistema	Code Codice	Iva esclusa Vat excluded Euro €
Wall and ceiling anchor for Radial System power cable max Ø 7 mm - 0.27" max capacity 5 kg  Cilindro di decentramento per Sistema Radiale cavo elettrico max Ø 7 mm - 0.27" Portata max 5 kg	 Clear Trasparente	Radial	999A4 00	21,00

Net weight / Peso netto: 0.02 kg

Pack / Colli: 1



Suspension lamp

Cluster suspension lamp

Canopy

Wall & Ceiling lamp

Floor & Table lamp

Outdoor lamp

Accessory

## Short Lights Track

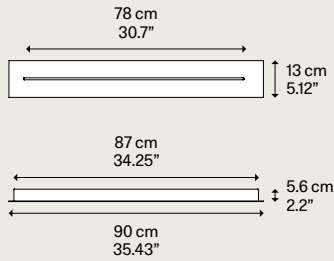

Net weight/Peso netto: 5.5 kg

Pack/Colli: 1

Iva esclusa

Vat excluded

Description Descrizione	Structure finish Finitura struttura	System Sistema	Code Codice	Euro €
Multiple linear track standard version max 7 suspensions Binario lineare multiplo versione standard max 7 sospensioni	Matte White - 9010 Bianco Opaco - 9010	Track	R08L07 1000	370,00
	Matte Black - 9005 Nero Opaco - 9005		R08L07 2000	370,00

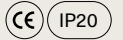

## Short Lights Track

Maximum quantity Quantità massima		Maximum quantity Quantità massima	
Suspension aligned Sospensione allineata		Staggered suspension Sospensione sfalsata	
Max 7	mod. A-Tube	Max 7	mod. A-Tube
Max 6	mod. A-Tube Nano	Max 6	mod. A-Tube Nano
Max 6	mod. A-Tube Nano Duo	Max 6	mod. A-Tube Nano Duo
Max 6	mod. IVY I	Max 7	mod. IVY I
Max 5	mod. Jefferson	Max 6	mod. Jefferson
Max 4	mod. JIM cylinder	Max 7	mod. JIM cylinder
Max 3	mod. JIM cone	Max 5	mod. JIM cone
Max 3	mod. JIM bell	Max 5	mod. JIM bell
Max 4	mod. Kelly Cluster	Max 7	mod. Kelly Cluster
Max 7	mod. Nostalgia small	Max 7	mod. Nostalgia small
Max 4	mod. Nostalgia medium	Max 7	mod. Nostalgia medium
Max 3	mod. Nostalgia large	Max 5	mod. Nostalgia large
Max 7	mod. Rain	Max 7	mod. Rain
Max 3	mod. Random	Max 5	mod. Random
Max 7	mod. Random Solo 12	Max 7	mod. Random Solo 12
Max 6	mod. Random Solo 14	Max 7	mod. Random Solo 14
Max 4	mod. Random Solo 18	Max 7	mod. Random Solo 18
Max 4	mod. Random Solo 23	Max 7	mod. Random Solo 23
Max 3	mod. Random Solo 28	Max 6	mod. Random Solo 28
Max 7	mod. Spider	Max 7	mod. Spider
Max 6	mod. Volum 14	Max 7	mod. Volum 14
Max 4	mod. Volum 22	Max 7	mod. Volum 22
Max 3	mod. Volum 29	Max 5	mod. Volum 29

## Long Lights Track

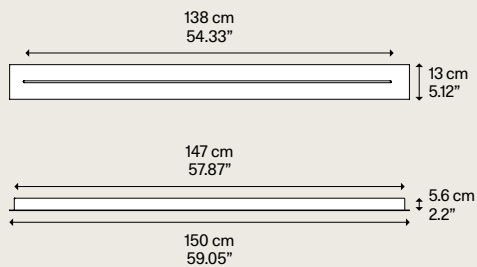

Net weight/Peso netto: 8.8 kg

Pack/Colli: 1

Description  
DescrizioneStructure finish  
Finitura strutturaSystem  
SistemaCode  
CodiceIva esclusa  
Vat excluded

Euro €

Multiple linear  
track standard  
version max  
11 suspensions

Matte White – 9010  
Bianco Opaco – 9010

Track

R08L11 1000 620,00

Binario lineare  
multiplo versione  
standard max  
11 sospensioni

Matte Black – 9005  
Nero Opaco – 9005

R08L11 2000 620,00

CE IP20

## Long Lights Track

Maximum quantity  
Quantità massimaMaximum quantity  
Quantità massimaSuspension aligned  
Sospensione allineataStaggered suspension  
Sospensione sfalsata

Max 11	mod. A-Tube
Max 10	mod. A-Tube Nano
Max 10	mod. A-Tube Nano Duo
Max 10	mod. IVY I
Max 8	mod. Jefferson
Max 8	mod. JIM cylinder
Max 5	mod. JIM cone
Max 5	mod. JIM bell
Max 8	mod. Kelly Cluster
Max 11	mod. Nostalgia small
Max 7	mod. Nostalgia medium
Max 5	mod. Nostalgia large
Max 11	mod. Rain
Max 5	mod. Random
Max 11	mod. Random Solo 12
Max 10	mod. Random Solo 14
Max 8	mod. Random Solo 18
Max 6	mod. Random Solo 23
Max 6	mod. Random Solo 28
Max 11	mod. Spider
Max 10	mod. Volum 14
Max 7	mod. Volum 22
Max 5	mod. Volum 29

Max 11	mod. A-Tube
Max 10	mod. A-Tube Nano
Max 10	mod. A-Tube Nano Duo
Max 11	mod. IVY I
Max 10	mod. Jefferson
Max 11	mod. JIM cylinder
Max 9	mod. JIM cone
Max 9	mod. JIM bell
Max 11	mod. Kelly Cluster
Max 11	mod. Nostalgia small
Max 11	mod. Nostalgia medium
Max 9	mod. Nostalgia large
Max 11	mod. Rain
Max 9	mod. Random
Max 11	mod. Random Solo 12
Max 11	mod. Random Solo 14
Max 11	mod. Random Solo 18
Max 11	mod. Random Solo 23
Max 10	mod. Random Solo 28
Max 11	mod. Spider
Max 11	mod. Volum 14
Max 11	mod. Volum 22
Max 9	mod. Volum 29

# Wall & Ceiling lamps

## Wall lamps

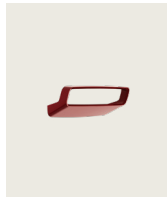

Aile  
Pag. 052

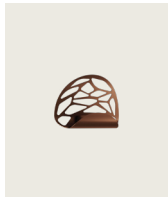

Kelly  
Pag. 054



Laser  
Pag. 055



Make-Up  
Pag. 056



Nautilus  
Pag. 057

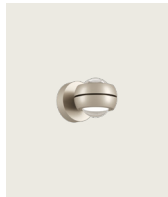

Nautilus Mini  
Pag. 057



Pin-Up  
Pag. 059

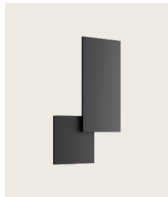

Puzzle  
Pag. 060

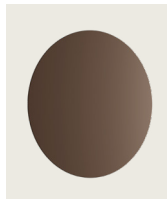

Puzzle Mega  
Pag. 061-063

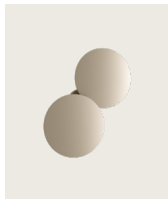

Puzzle Round  
Pag. 064



Volum  
Pag. 066, 067

NEW LAMP

## Ceiling lamps



A-Tube  
Pag. 051



Bugia  
Pag. 052-054



Make-Up  
Pag. 056



Nautilus  
Pag. 058

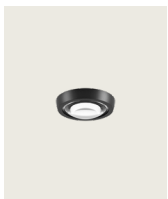

Nautilus Spot  
Pag. 058



Pin-Up  
Pag. 059



Puzzle  
Pag. 060



Puzzle Mega  
Pag. 061-063



Puzzle Round  
Pag. 064

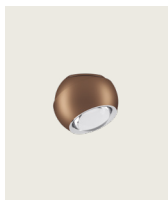

Spider  
Pag. 065



Tidal  
Pag. 065

NEW LAMP



Volum  
Pag. 066

NEW LAMP

# A-Tube, design by Studio Italia Design, 2013

Ceiling lamp

## A-Tube mini

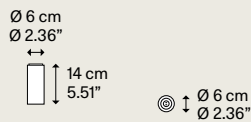

**Light source**  
Sorgente luminosa

GU10 Par 16  
↘ 1 × max 40W Eco  
⏏

or

GU10 Par 16 LED  
↘ 1 × 10 W ⏏

W/L max 9 cm  
W/L max 3.54"

Bulb not included  
Lampadina non inclusa

**Metal structure**  
Montatura in metallo

Matte White - 9010  
Bianco Opaco - 9010

Matte Black - 9005  
Nero Opaco - 9005

Coppery Bronze  
Bronzo Ramato

**Code**  
Codice **Euro €**

09631 1000 115,00

09631 2000 115,00

09631 3500 120,00

Iva esclusa  
Vat excluded

Net weight/Peso netto: 0.2 kg

Pack/Colli: 1

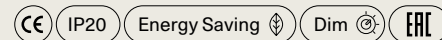

## A-Tube small

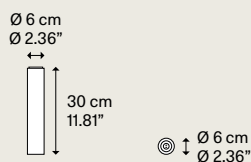

**Light source**  
Sorgente luminosa

GU10 Par 16  
↘ 1 × max 40W Eco  
⏏

or

GU10 Par 16 LED  
↘ 1 × 10 W ⏏

W/L max 9 cm  
W/L max 3.54"

Bulb not included  
Lampadina non inclusa

**Metal structure**  
Montatura in metallo

Matte White - 9010  
Bianco Opaco - 9010

Matte Black - 9005  
Nero Opaco - 9005

Coppery Bronze  
Bronzo Ramato

**Code**  
Codice **Euro €**

09632 1000 160,00

09632 2000 160,00

09632 3500 165,00

Iva esclusa  
Vat excluded

Net weight/Peso netto: 0.8 kg

Pack/Colli: 1

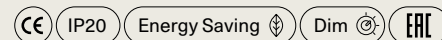

## A-Tube medium

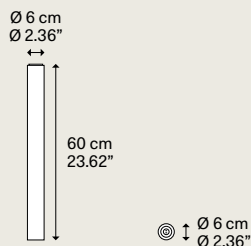

**Light source**  
Sorgente luminosa

GU10 Par 16  
↘ 1 × max 40W Eco  
⏏

or

GU10 Par 16 LED  
↘ 1 × 10 W ⏏

W/L max 9 cm  
W/L max 3.54"

Bulb not included  
Lampadina non inclusa

**Metal structure**  
Montatura in metallo

Matte White - 9010  
Bianco Opaco - 9010

Matte Black - 9005  
Nero Opaco - 9005

Coppery Bronze  
Bronzo Ramato

**Code**  
Codice **Euro €**

09633 1000 235,00

09633 2000 235,00

09633 3500 250,00

Iva esclusa  
Vat excluded

Net weight/Peso netto: 0.9 kg

Pack/Colli: 1

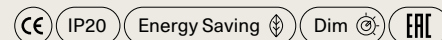

## A-Tube large

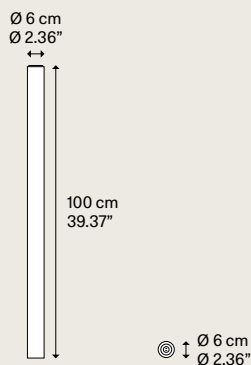

**Light source**  
Sorgente luminosa

GU10 Par 16  
↘ 1 × max 40W Eco  
⏏

or

GU10 Par 16 LED  
↘ 1 × 10 W ⏏

W/L max 9 cm  
W/L max 3.54"

Bulb not included  
Lampadina non inclusa

**Metal structure**  
Montatura in metallo

Matte White - 9010  
Bianco Opaco - 9010

Matte Black - 9005  
Nero Opaco - 9005

Coppery Bronze  
Bronzo Ramato

**Code**  
Codice **Euro €**

09634 1000 315,00

09634 2000 315,00

09634 3500 345,00

Iva esclusa  
Vat excluded

Net weight/Peso netto: 1.5 kg

Pack/Colli: 1

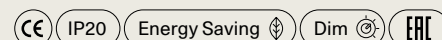

Suspension lamp  
Cluster suspension lamp  
Canopy  
Wall & Ceiling lamp  
Floor & Table lamp  
Outdoor lamp  
Accessory

# Aile, design by Luca Nichetto, 2021

Wall lamp

## Aile

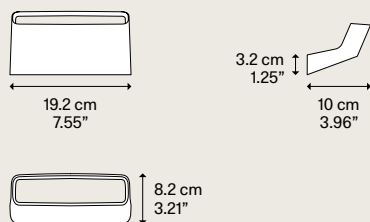

**Light source**  
Sorgente luminosa

LED  
 ↘ 2700 K  
 ↘ 2 × 8 W/1840 lm  
 ↘ 220-240 V  
 ↘ CRI 92  
 ↘ MacAdam 3-Step

or

LED  
 ↘ 3000 K  
 ↘ 2 × 8 W/1960 lm  
 ↘ 220-240 V  
 ↘ CRI 92  
 ↘ MacAdam 3-Step

LED included  
LED incluso

**Metal structure**  
Montatura in metallo

● Matte White - 9010  
Bianco Opaco - 9010

● Matte Black - 9005  
Nero Opaco - 9005

● Champagne  
Champagne

● Lacquer Red  
Rosso Lacca

● Matte White - 9010  
Bianco Opaco - 9010

● Matte Black - 9005  
Nero Opaco - 9005

● Champagne  
Champagne

● Lacquer Red  
Rosso Lacca

Iva esclusa  
Vat excluded

Code Codice	Euro €
17550 1027	160,00
17550 2027	160,00
17550 4527	185,00
17550 6027	260,00
17550 1030	160,00
17550 2030	160,00
17550 4530	185,00
17550 6030	260,00

Net weight/Peso netto: 0.55 kg

Pack/Colli: 1

Energy class/Classe energetica: E

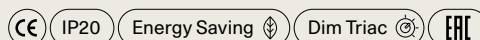

# Bugia, design by Andrea Tosetto, 2016

Ceiling lamp

## Bugia Single

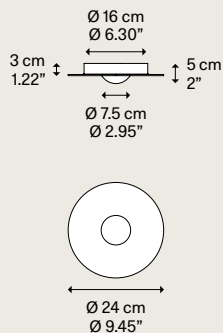

**Light source**  
Sorgente luminosa

LED  
 ↘ 2700 K  
 ↘ 15 W/1245 lm  
 ↘ 220-240 V  
 ↘ CRI 90  
 ↘ MacAdam 3-Step

or

LED  
 ↘ 3000 K  
 ↘ 15 W/1355 lm  
 ↘ 220-240 V  
 ↘ CRI 90  
 ↘ MacAdam 3-Step

LED included  
LED incluso

**Metal structure**  
Montatura in metallo

● Matte White - 9010  
Bianco Opaco - 9010

● Matte White - 9010  
Bianco Opaco - 9010

**Methacrylate diffuser**  
Diffusore in metacrilato

● Glossy White  
Bianco Lucido

● Glossy Black  
Nero Lucido

● Chrome  
Cromo

● Glossy Bronze  
Bronzo Lucido

● Glossy White  
Bianco Lucido

● Glossy Black  
Nero Lucido

● Chrome  
Cromo

● Glossy Bronze  
Bronzo Lucido

Iva esclusa  
Vat excluded

Code Codice	Euro €
16131 1227	245,00
16131 2227	245,00
16131 4027	245,00
16131 4627	245,00
16131 1230	245,00
16131 2230	245,00
16131 4030	245,00
16131 4630	245,00

Net weight/Peso netto: 0.8 kg

Pack/Colli: 2

Energy class/Classe energetica: F

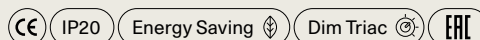

Ecodesign regulation ► pag. 084-085  
Regolamento di Ecodesign ► pag. 084-085

LED sources with direct power supply to the AC line voltage - driver not required. Dimmable with phase cut dimmer.

LED con alimentazione diretta a tensione di rete - non necessita di driver. Dimmerabile con varialuce a taglio di fase.

# Bugia, design by Andrea Tosetto, 2016

Ceiling lamp

## Bugia Double

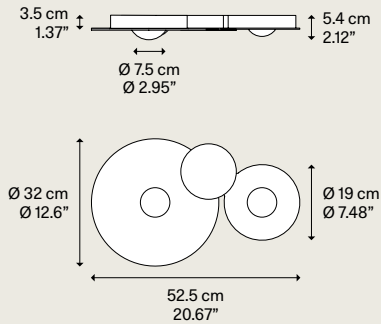

**Light source**  
Sorgente luminosa

LED  
 ↘ 2700 K  
 ↘ 2 × 15 W / 2490 lm  
 ↘ 220–240 V  
 ↘ CRI 90  
 ↘ MacAdam 3–Step

**Metal structure**  
Montatura in metallo

Matte White – 9010  
Bianco Opaco – 9010

or

LED  
 ↘ 3000 K  
 ↘ 2 × 15 W / 2710 lm  
 ↘ 220–240 V  
 ↘ CRI 90  
 ↘ MacAdam 3–Step

Matte White – 9010  
Bianco Opaco – 9010

LED included  
LED incluso

**Methacrylate diffuser**  
Diffusore in metacrilato

Glossy White  
Bianco Lucido  
16132 1227 435,00

Glossy Black  
Nero Lucido  
16132 2227 435,00

Chrome  
Cromo  
16132 4027 435,00

Glossy Bronze  
Bronzo Lucido  
16132 4627 435,00

Glossy White  
Bianco Lucido  
16132 1230 435,00

Glossy Black  
Nero Lucido  
16132 2230 435,00

Chrome  
Cromo  
16132 4030 435,00

Glossy Bronze  
Bronzo Lucido  
16132 4630 435,00

Iva esclusa  
Vat excluded

Euro €

Net weight/Peso netto: 2.05 kg

Pack/Coll: 2

Energy class/Classe energetica: F

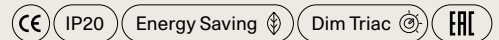

## Bugia Triple

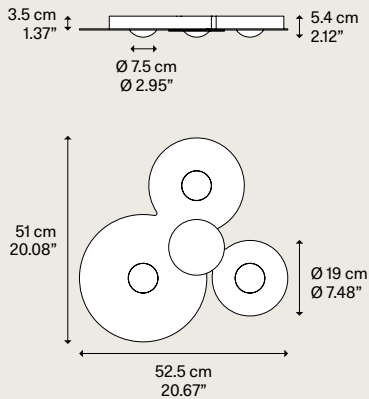

**Light source**  
Sorgente luminosa

LED  
 ↘ 2700 K  
 ↘ 3 × 15 W / 3735 lm  
 ↘ 220–240 V  
 ↘ CRI 90  
 ↘ MacAdam 3–Step

**Metal structure**  
Montatura in metallo

Matte White – 9010  
Bianco Opaco – 9010

or

LED  
 ↘ 3000 K  
 ↘ 3 × 15 W / 4065 lm  
 ↘ 220–240 V  
 ↘ CRI 90  
 ↘ MacAdam 3–Step

Matte White – 9010  
Bianco Opaco – 9010

LED included  
LED incluso

**Methacrylate diffuser**  
Diffusore in metacrilato

Glossy White  
Bianco Lucido  
16133 1227 570,00

Glossy Black  
Nero Lucido  
16133 2227 570,00

Chrome  
Cromo  
16133 4027 570,00

Glossy Bronze  
Bronzo Lucido  
16133 4627 570,00

Glossy White  
Bianco Lucido  
16133 1230 570,00

Glossy Black  
Nero Lucido  
16133 2230 570,00

Chrome  
Cromo  
16133 4030 570,00

Glossy Bronze  
Bronzo Lucido  
16133 4630 570,00

Iva esclusa  
Vat excluded

Euro €

Net weight/Peso netto: 2.8 kg

Pack/Coll: 2

Energy class/Classe energetica: F

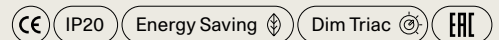

Ecodesign regulation ► pag. 084–085  
Regolamento di Ecodesign ► pag. 084–085

# Bugia Mega, design by Andrea Tosetto, 2020

Ceiling lamp

## Bugia Mega

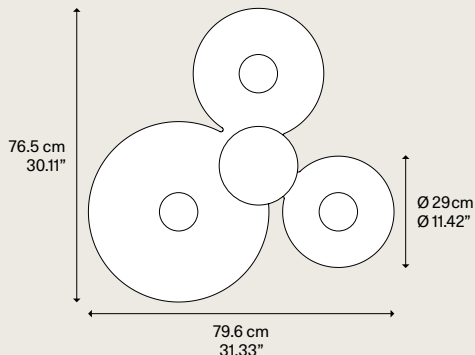
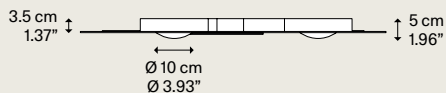

**Light source**  
Sorgente luminosa

LED  
 ↗ 2700 K  
 ↗ 3 × 15 W/3735 lm  
 ↗ 220-240 V  
 ↗ CRI 90  
 ↗ MacAdam 3-Step

or

LED  
 ↗ 3000 K  
 ↗ 3 × 15 W/4065 lm  
 ↗ 220-240 V  
 ↗ CRI 90  
 ↗ MacAdam 3-Step

LED included  
LED incluso

**Metal structure**  
Montatura in metallo

● Matte White - 9010  
Bianco Opaco - 9010

● Matte White - 9010  
Bianco Opaco - 9010

**Methacrylate diffuser**  
Diffusore in metacrilato

● Glossy White  
Bianco Lucido

● Glossy Black  
Nero Lucido

● Chrome  
Cromo

● Glossy Bronze  
Bronzo Lucido

● Glossy White  
Bianco Lucido

● Glossy Black  
Nero Lucido

● Chrome  
Cromo

● Glossy Bronze  
Bronzo Lucido

**Code**  
Codice

16134 1227

16134 2227

16134 4027

16134 4627

16134 1230

16134 2230

16134 4030

16134 4630

Iva esclusa  
Vat excluded  
**Euro €**

830,00

830,00

830,00

830,00

830,00

830,00

830,00

830,00

Net weight/Peso netto: 4.4 kg

Pack/Colli: 2

Energy class/Classe energetica: F

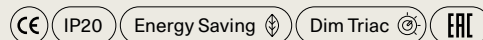

Ecodesign regulation ► pag. 084-085  
Regolamento di Ecodesign ► pag. 084-085

# Kelly, design by Andrea Tosetto, 2015

Wall lamp

## Kelly

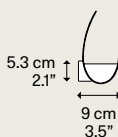
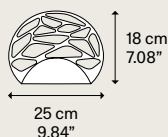

**Light source**  
Sorgente luminosa

LED  
 ↗ 2700 K  
 ↗ 15 W/1750 lm  
 ↗ 220-220 V  
 ↗ CRI 92  
 ↗ MacAdam 3-Step

LED included  
LED incluso

**Metal structure**  
Montatura in metallo

● Matte White - 9010  
Bianco Opaco - 9010

● Coppery Bronze  
Bronzo Ramato

**Code**  
Codice

14150 1027

14150 3527

Iva esclusa  
Vat excluded  
**Euro €**

260,00

270,00

Net weight/Peso netto: 0.8 kg

Pack/Colli: 1

Energy class/Classe energetica: F

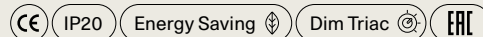

Ecodesign regulation ► pag. 084-085  
Regolamento di Ecodesign ► pag. 084-085



# Laser, design by Studio Italia Design, 2015

Wall lamp

## Laser 10 × 10 LED

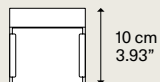
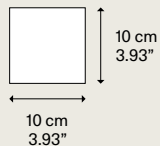

Light source Sorgente luminosa	Metal structure Montatura in metallo	Code Codice	Iva esclusa Vat excluded Euro €
LED ↘ 2700 K ↘ 15 W/1750 lm ↘ 220-240 V ↘ CRI 92 ↘ MacAdam 3-Step	Matte White - 9010 Bianco Opaco - 9010	03652 1027	160,00
	Matte Black - 9005 Nero Opaco - 9005	03652 2027	160,00
	Champagne Champagne	03652 4527	170,00
	or		
LED ↘ 3000 K ↘ 15 W/1850 lm ↘ 220-240 V ↘ CRI 92 ↘ MacAdam 3-Step	Matte White - 9010 Bianco Opaco - 9010	03652 1030	160,00
	Matte Black - 9005 Nero Opaco - 9005	03652 2030	160,00
	Champagne Champagne	03652 4530	170,00

LED included  
LED incluso

Net weight/Peso netto: 0.6 kg	Pack/Colli: 1	Energy class/Classe energetica: F
-------------------------------	---------------	-----------------------------------

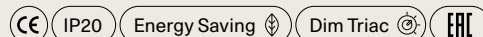

Ecodesign regulation ► pag. 084-085  
Regolamento di Ecodesign ► pag. 084-085

Suspension lamp  
Cluster suspension lamp  
Canopy  
Wall & Ceiling lamp  
Floor & Table lamp  
Outdoor lamp  
Accessory

# Make-Up, design by Studio Italia Design, 2015

Wall lamp

Ceiling lamp

## Make-Up small

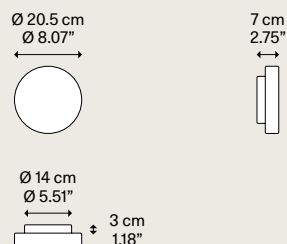

### Light source Sorgente luminosa

LED  
 ↘ 3000 K  
 ↘ 8 W / 980 lm  
 ↘ 220-240 V  
 ↘ CRI 92  
 ↘ MacAdam 3-Step

LED included  
 LED incluso

### Metal structure Montatura in metallo

● Matte White - 9016  
 ● Bianco Opaco - 9016

### Blown glass diffuser Diffusore in vetro soffiato

● Frosted White  
 ● Bianco Satinato

### Code Codice

15041 30

Iva esclusa  
 Vat excluded  
**Euro €**  
 230,00

Net weight/Peso netto: 1.3 kg

Pack/Coll: 1

Energy class/Classe energetica: F

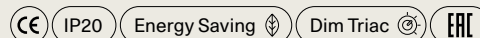

## Make-Up medium

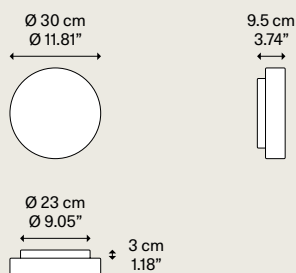

### Light source Sorgente luminosa

LED  
 ↘ 3000 K  
 ↘ 15 W / 1850 lm  
 ↘ 220-240 V  
 ↘ CRI 92  
 ↘ MacAdam 3-Step

LED included  
 LED incluso

### Metal structure Montatura in metallo

● Matte White - 9016  
 ● Bianco Opaco - 9016

### Blown glass diffuser Diffusore in vetro soffiato

● Frosted White  
 ● Bianco Satinato

### Code Codice

15042 30

Iva esclusa  
 Vat excluded  
**Euro €**  
 315,00

Net weight/Peso netto: 2.32 kg

Pack/Coll: 1

Energy class/Classe energetica: F

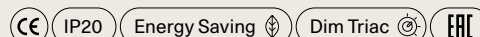

## Make-Up large

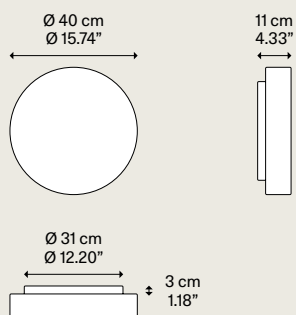

### Light source Sorgente luminosa

LED  
 ↘ 3000 K  
 ↘ 15 W / 1850 lm  
 ↘ 220-240 V  
 ↘ CRI 92  
 ↘ MacAdam 3-Step

LED included  
 LED incluso

### Metal structure Montatura in metallo

● Matte White - 9016  
 ● Bianco Opaco - 9016

### Blown glass diffuser Diffusore in vetro soffiato

● Frosted White  
 ● Bianco Satinato

### Code Codice

15043 30

Iva esclusa  
 Vat excluded  
**Euro €**  
 440,00

Net weight/Peso netto: 3.88 kg

Pack/Coll: 1

Energy class/Classe energetica: F

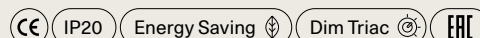

Ecodesign regulation ▶ pag. 084-085  
 Regolamento di Ecodesign ▶ pag. 084-085

▶ LED sources with direct power supply to the AC line voltage - driver not required. Dimmable with phase cut dimmer. ▶ You can connect up to 3 Make-Up to each fixture directly connected to the power supply. You can also connect up to 2 additional fixtures to each of those for maximum total of 50 fixtures on a single power outlet.

▶ LED con alimentazione diretta a tensione di rete - non necessita di driver. Dimmerabile con varialuce a taglio di fase. ▶ Ad ogni Make-Up connessa al punto di alimentazione elettrica possono esserne collegate altre 3. Ad ognuna di queste possono esserne collegate fino a 2 e così via. Le lampade totali collegabili su un singolo punto di alimentazione sono 50.

# Nautilus, design by Andrea Tosetto, 2017

Wall lamp

## Nautilus

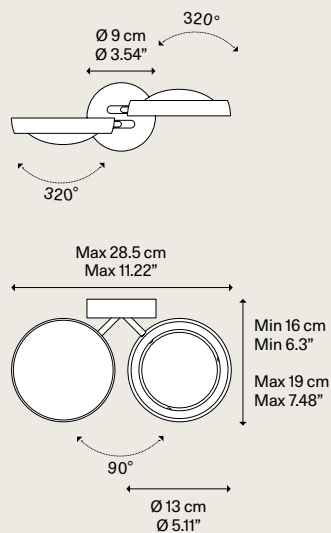

Adjustable light  
Luce orientabile

Light source Sorgente luminosa	Metal structure Montatura in metallo	Metal diffuser Diffusore in metallo	Code Codice	Iva esclusa Vat excluded Euro €	
LED ↘ 2700 K ↘ 2 × 12 W / 1990 lm ↘ 220–240 V ↘ CRI 90 ↘ MacAdam 3–Step	● Matte White – 9010 Bianco Opaco – 9010	● Matte White – 9010 Bianco Opaco – 9010	16550 1927	360,00	
	● Matte Black – 9005 Nero Opaco – 9005	● Matte Black – 9005 Nero Opaco – 9005	16550 2927	360,00	
	● Chrome Cromo	● Chrome Cromo	16550 4027	380,00	
	● Matte Champagne Champagne Opaco	● Matte Champagne Champagne Opaco	16550 4927	380,00	
	○ or ○	● Matte White – 9010 Bianco Opaco – 9010	● Matte White – 9010 Bianco Opaco – 9010	16550 1930	360,00
	LED ↘ 3000 K ↘ 2 × 12 W / 2170 lm ↘ 220–240 V ↘ CRI 90 ↘ MacAdam 3–Step	● Matte Black – 9005 Nero Opaco – 9005	● Matte Black – 9005 Nero Opaco – 9005	16550 2930	360,00
LED included LED incluso	● Chrome Cromo	● Chrome Cromo	16550 4030	380,00	
	● Matte Champagne Champagne Opaco	● Matte Champagne Champagne Opaco	16550 4930	380,00	



Net weight/Peso netto: 1.15 kg

Pack/Colli: 1

Energy class/Classe energetica: F

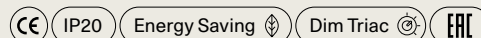

Wall lamp

## Nautilus Mini

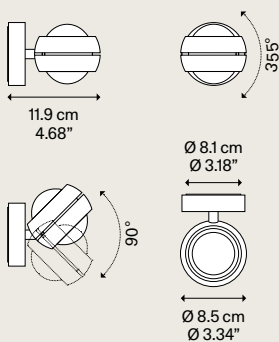

Adjustable light  
Luce orientabile

Light source Sorgente luminosa	Metal structure Montatura in metallo	Code Codice	Iva esclusa Vat excluded Euro €
LED ↘ 2700 K ↘ 2 × 6 W / 950 lm ↘ 220–240 V ↘ CRI 90 ↘ MacAdam 3–Step	● Matte White – 9010 Bianco Opaco – 9010	16552 1027	245,00
	● Matte Black – 9005 Nero Opaco – 9005	16552 2027	245,00
	● Matte Champagne Champagne Opaco	16552 4527	260,00
○ or ○	● Matte White – 9010 Bianco Opaco – 9010	16552 1030	245,00
LED ↘ 3000 K ↘ 2 × 6 W / 1030 lm ↘ 220–240 V ↘ CRI 90 ↘ MacAdam 3–Step	● Matte Black – 9005 Nero Opaco – 9005	16552 2030	245,00
	● Matte Champagne Champagne Opaco	16552 4530	260,00

LED included  
LED incluso



Net weight/Peso netto: 0.75 kg

Pack/Colli: 1

Energy class/Classe energetica: G

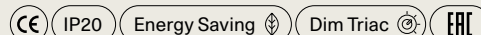

Ecodesign regulation ► pag. 084–085  
Regolamento di Ecodesign ► pag. 084–085

LED sources with direct power supply  
to the AC line voltage – driver not required.  
Dimmable with phase cut dimmer.

LED con alimentazione diretta a tensione  
di rete – non necessita di driver.  
Dimmerabile con varialuce a taglio di fase.

# Nautilus, design by Andrea Tosetto, 2017

Ceiling lamp

## Nautilus

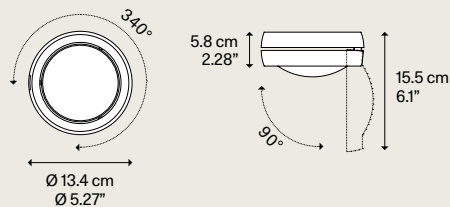

**Light source**  
Sorgente luminosa

**Metal structure**  
Montatura in metallo

Iva esclusa  
Vat excluded  
**Code**  
Codice **Euro €**

LED  
 ↘ 2700 K  
 ↘ 12 W/995 lm  
 ↘ 220-240 V  
 ↘ CRI 90  
 ↘ MacAdam 3-Step

● Matte White - 9010  
Bianco Opaco - 9010

16530 1027 245,00

● Matte Black - 9005  
Nero Opaco - 9005

16530 2027 245,00

◐ Chrome  
Cromo

16530 4027 285,00

◐ Matte Champagne  
Champagne Opaco

16530 4527 265,00

or

● Matte White - 9010  
Bianco Opaco - 9010

16530 1030 245,00

● Matte Black - 9005  
Nero Opaco - 9005

16530 2030 245,00

◐ Chrome  
Cromo

16530 4030 285,00

◐ Matte Champagne  
Champagne Opaco

16530 4530 265,00

LED included  
LED incluso



Adjustable light  
Luce orientabile

Net weight/Peso netto: 1.10 kg

Pack/Colli: 1

Energy class/Classe energetica: F

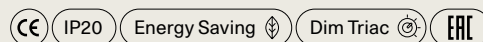

# Nautilus Spot, design by Andrea Tosetto, 2020

Ceiling lamp

## Nautilus Spot

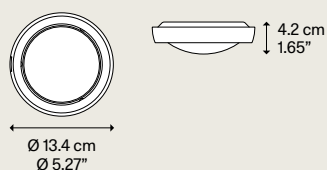

**Light source**  
Sorgente luminosa

**Metal structure**  
Montatura in metallo

Iva esclusa  
Vat excluded  
**Code**  
Codice **Euro €**

LED  
 ↘ 2700 K  
 ↘ 10 W/945 lm  
 ↘ 220-240 V  
 ↘ CRI 90  
 ↘ MacAdam 3-Step

● Matte White - 9010  
Bianco Opaco - 9010

16560 1027 185,00

● Matte Black - 9005  
Nero Opaco - 9005

16560 2027 185,00

◐ Chrome  
Cromo

16560 4027 200,00

◐ Matte Champagne  
Champagne Opaco

16560 4527 195,00

or

● Matte White - 9010  
Bianco Opaco - 9010

16560 1030 185,00

● Matte Black - 9005  
Nero Opaco - 9005

16560 2030 185,00

◐ Chrome  
Cromo

16560 4030 200,00

◐ Matte Champagne  
Champagne Opaco

16560 4530 195,00

LED included  
LED incluso

Net weight/Peso netto: 0.56 kg

Pack/Colli: 1

Energy class/Classe energetica: F

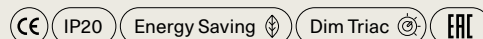

Ecodesign regulation ► pag. 084-085  
Regolamento di Ecodesign ► pag. 084-085

LED sources with direct power supply  
to the AC line voltage - driver not required.  
Dimmable with phase cut dimmer.

LED con alimentazione diretta a tensione  
di rete - non necessita di driver.  
Dimmerabile con varialuce a taglio di fase.

# Pin-Up, design by Andrea Tosetto, 2015

Wall lamp

Ceiling lamp

## Pin-Up

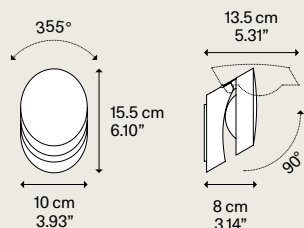

Light source  
Sorgente luminosa

Metal structure  
Montatura in metallo

Iva esclusa  
Vat excluded  
Code  
Codice Euro €

LED  
 ↘ 2700 K  
 ↘ 8 W/920 lm  
 ↘ 220-240 V  
 ↘ CRI 92  
 ↘ MacAdam 3-Step

Matte White - 9010  
Bianco Opaco - 9010

15540 1027 230,00

Matte Black - 9005  
Nero Opaco - 9005

15540 2027 230,00

Coppery Bronze  
Bronzo Ramato

15540 3527 235,00

or

Matte White - 9010  
Bianco Opaco - 9010

15540 1030 230,00

Matte Black - 9005  
Nero Opaco - 9005

15540 2030 230,00

Coppery Bronze  
Bronzo Ramato

15540 3530 235,00

LED included  
LED incluso



Adjustable light  
Luce orientabile

Net weight/Peso netto: 1.15 kg

Pack/Colli: 1

Energy class/Classe energetica: E

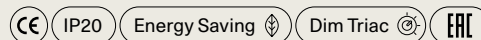

Ecodesign regulation ► pag. 084-085  
Regolamento di Ecodesign ► pag. 084-085

# Puzzle, design by Studio Italia Design, 2014

Wall lamp

Ceiling lamp

## Puzzle single square

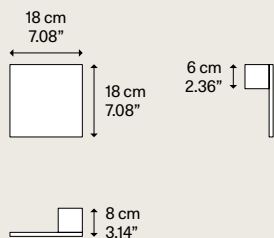

### Light source Sorgente luminosa

LED  
 ↘ 2700 K  
 ↘ 15 W/1750 lm  
 ↘ 220-240 V  
 ↘ CRI 92  
 ↘ MacAdam 3-Step

or

LED  
 ↘ 3000 K  
 ↘ 15 W/1850 lm  
 ↘ 220-240 V  
 ↘ CRI 92  
 ↘ MacAdam 3-Step

LED included  
 LED incluso

### Metal structure Montatura in metallo

● Matte White - 9016  
 Bianco Opaco - 9016

● Matte Black - 9005  
 Nero Opaco - 9005

● Matte White - 9016  
 Bianco Opaco - 9016

● Matte Black - 9005  
 Nero Opaco - 9005

Iva esclusa  
 Vat excluded

Code Codice	Euro €
14641 1027	199,00
14641 2027	199,00
14641 1030	199,00
14641 2030	199,00

Net weight/Peso netto: 1.16 kg

Pack/Colli: 1

Energy class/Classe energetica: F

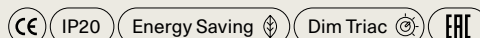

## Puzzle double square

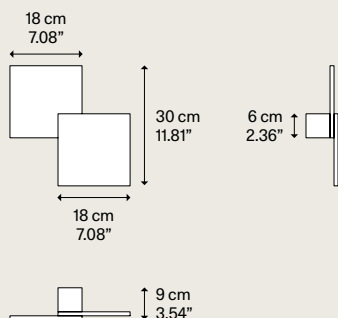

### Light source Sorgente luminosa

LED  
 ↘ 2700 K  
 ↘ 2 × 15 W/3500 lm  
 ↘ 220-240 V  
 ↘ CRI 92  
 ↘ MacAdam 3-Step

or

LED  
 ↘ 3000 K  
 ↘ 2 × 15 W/3700 lm  
 ↘ 220-240 V  
 ↘ CRI 92  
 ↘ MacAdam 3-Step

LED included  
 LED incluso

### Metal structure Montatura in metallo

● Matte White - 9016  
 Bianco Opaco - 9016

● Matte Black - 9005  
 Nero Opaco - 9005

● Matte White - 9016  
 Bianco Opaco - 9016

● Matte Black - 9005  
 Nero Opaco - 9005

Iva esclusa  
 Vat excluded

Code Codice	Euro €
14642 1027	310,00
14642 2027	310,00
14642 1030	310,00
14642 2030	310,00

Net weight/Peso netto: 2 kg

Pack/Colli: 1

Energy class/Classe energetica: F

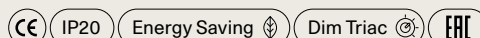

## Puzzle square & rectangle

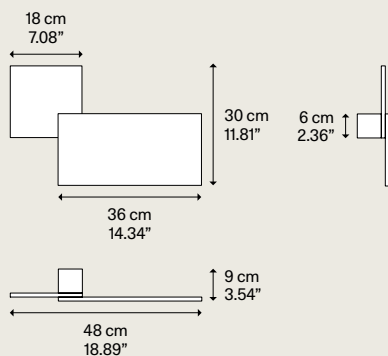

### Light source Sorgente luminosa

LED  
 ↘ 2700 K  
 ↘ 2 × 15 W/3500 lm  
 ↘ 220-240 V  
 ↘ CRI 92  
 ↘ MacAdam 3-Step

or

LED  
 ↘ 3000 K  
 ↘ 2 × 15 W/3700 lm  
 ↘ 220-240 V  
 ↘ CRI 92  
 ↘ MacAdam 3-Step

LED included  
 LED incluso

### Metal structure Montatura in metallo

● Matte White - 9016  
 Bianco Opaco - 9016

● Matte Black - 9005  
 Nero Opaco - 9005

● Matte White - 9016  
 Bianco Opaco - 9016

● Matte Black - 9005  
 Nero Opaco - 9005

Iva esclusa  
 Vat excluded

Code Codice	Euro €
14643 1027	365,00
14643 2027	365,00
14643 1030	365,00
14643 2030	365,00

Net weight/Peso netto: 2.91 kg

Pack/Colli: 1

Energy class/Classe energetica: F

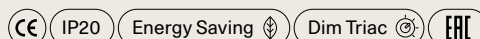

Ecodesign regulation ► pag. 084-085  
 Regolamento di Ecodesign ► pag. 084-085

► LED sources with direct power supply to the AC line voltage – driver not required.  
 Dimmable with phase cut dimmer.  
 ► Optional backplate available.

► LED con alimentazione diretta a tensione di rete – non necessita di driver.  
 Dimmerabile con varialuce a taglio di fase.  
 ► Disponibile piastra a muro opzionale.

# Puzzle Mega, design by Studio Italia Design, 2019

Wall lamp

Ceiling lamp

## Puzzle Mega round small

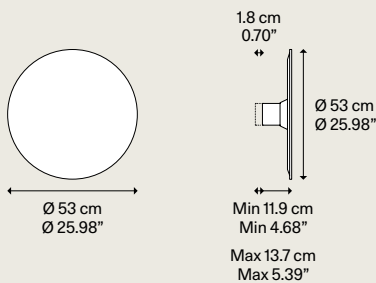

**Light source**  
Sorgente luminosa

**Metal structure**  
Montatura in metallo

**MDF diffuser**  
Diffusore in MDF

**Code**  
Codice **Euro €**  
Iva esclusa  
Vat excluded

LED  
 ↘ 2700 K  
 ↘ 3 × 15 W / 5250 lm  
 ↘ 220–240 V  
 ↘ CRI 92  
 ↘ MacAdam 3–Step

Matte White – 9016  
Bianco Opaco – 9016

Matte White – 9016  
Bianco Opaco – 9016

16741 1027 550,00

Matte Black – 9005  
Nero Opaco – 9005

16741 2027 620,00

Taupe  
Grigio Caldo

16741 3927 620,00

Red  
Rosso

16741 6027 620,00

or

Matte White – 9016  
Bianco Opaco – 9016

16741 1030 550,00

Matte Black – 9005  
Nero Opaco – 9005

16741 2030 620,00

Taupe  
Grigio Caldo

16741 3930 620,00

Red  
Rosso

16741 6030 620,00

LED included  
LED incluso

Net weight/Peso netto: 3.8 kg

Pack/Colli: 2

Energy class/Classe energetica: F

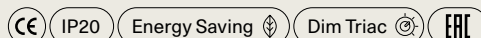

## Puzzle Mega round large

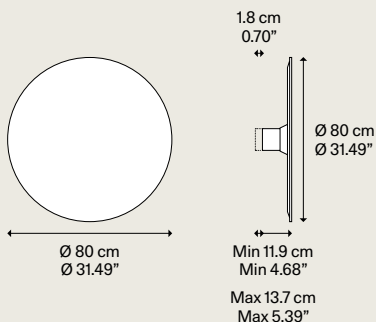

**Light source**  
Sorgente luminosa

**Metal structure**  
Montatura in metallo

**MDF diffuser**  
Diffusore in MDF

**Code**  
Codice **Euro €**  
Iva esclusa  
Vat excluded

LED  
 ↘ 2700 K  
 ↘ 4 × 15 W / 7000 lm  
 ↘ 220–240 V  
 ↘ CRI 92  
 ↘ MacAdam 3–Step

Matte White – 9016  
Bianco Opaco – 9016

Matte White – 9016  
Bianco Opaco – 9016

16744 1027 935,00

Matte Black – 9005  
Nero Opaco – 9005

16744 2027 1020,00

Taupe  
Grigio Caldo

16744 3927 1020,00

Red  
Rosso

16744 6027 1020,00

or

Matte White – 9016  
Bianco Opaco – 9016

16744 1030 935,00

Matte Black – 9005  
Nero Opaco – 9005

16744 2030 1020,00

Taupe  
Grigio Caldo

16744 3930 1020,00

Red  
Rosso

16744 6030 1020,00

LED included  
LED incluso

Net weight/Peso netto: 7.2 kg

Pack/Colli: 2

Energy class/Classe energetica: F

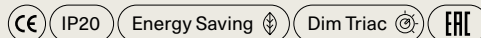

Ecodesign regulation ▶ pag. 084–085  
Regolamento di Ecodesign ▶ pag. 084–085

▶ LED sources with direct power supply to the AC line voltage – driver not required. Dimmable with phase cut dimmer.  
 ▶ You can connect up to 4 Puzzle Mega to each fixture directly connected to the power supply. You can also connect up to 3 additional fixtures to each of those for maximum total of 36 fixtures on a single power outlet.

▶ LED con alimentazione diretta a tensione di rete – non necessita di driver. Dimmerabile con varialuce a taglio di fase.  
 ▶ Ad ogni Puzzle Mega connessa al punto di alimentazione elettrica possono esserne collegate altre 4. Ad ognuna di queste possono esserne collegate fino ad altre 3 e così via. Le lampade totali collegabili su un singolo punto di alimentazione sono 36.

# Puzzle Mega, design by Studio Italia Design, 2019

Wall lamp

Ceiling lamp

## Puzzle Mega square small

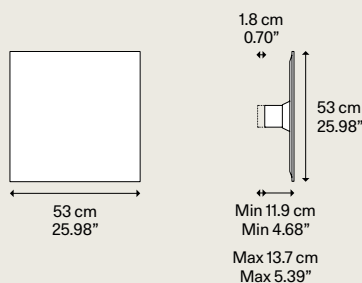

**Light source**  
Sorgente luminosa

**Metal structure**  
Montatura in metallo

**MDF diffuser**  
Diffusore in MDF

**Code**  
Codice

Iva esclusa  
Vat excluded  
**Euro €**

LED  
 ↘ 2700 K  
 ↘ 3 × 15 W/5250 lm  
 ↘ 220–240 V  
 ↘ CRI 92  
 ↘ MacAdam 3–Step

● Matte White – 9016  
Bianco Opaco – 9016

● Matte White – 9016  
Bianco Opaco – 9016

16742 1027

550,00

● Matte Black – 9005  
Nero Opaco – 9005

16742 2027

620,00

● Taupe  
Grigio Caldo

16742 3927

620,00

● Red  
Rosso

16742 6027

620,00

or

● Matte White – 9016  
Bianco Opaco – 9016

16742 1030

550,00

● Matte Black – 9005  
Nero Opaco – 9005

16742 2030

620,00

● Taupe  
Grigio Caldo

16742 3930

620,00

● Red  
Rosso

16742 6030

620,00

LED included  
LED incluso

Net weight/Peso netto: 4.1 kg

Pack/Colli: 2

Energy class/Classe energetica: F



IP20

Energy Saving

Dim Triac



## Puzzle Mega square large

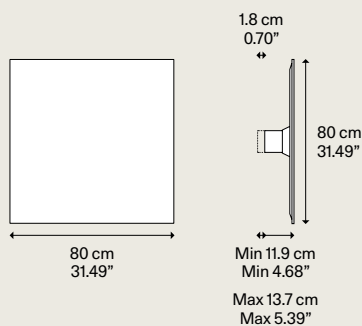

**Light source**  
Sorgente luminosa

**Metal structure**  
Montatura in metallo

**MDF diffuser**  
Diffusore in MDF

**Code**  
Codice

Iva esclusa  
Vat excluded  
**Euro €**

LED  
 ↘ 2700 K  
 ↘ 4 × 15 W/7000 lm  
 ↘ 220–240 V  
 ↘ CRI 92  
 ↘ MacAdam 3–Step

● Matte White – 9016  
Bianco Opaco – 9016

● Matte White – 9016  
Bianco Opaco – 9016

16745 1027

935,00

● Matte Black – 9005  
Nero Opaco – 9005

16745 2027

1020,00

● Taupe  
Grigio Caldo

16745 3927

1020,00

● Red  
Rosso

16745 6027

1020,00

or

● Matte White – 9016  
Bianco Opaco – 9016

16745 1030

935,00

● Matte Black – 9005  
Nero Opaco – 9005

16745 2030

1020,00

● Taupe  
Grigio Caldo

16745 3930

1020,00

● Red  
Rosso

16745 6030

1020,00

LED included  
LED incluso

Net weight/Peso netto: 8.8 kg

Pack/Colli: 2

Energy class/Classe energetica: F



IP20

Energy Saving

Dim Triac



Ecodesign regulation ► pag. 084–085  
Regolamento di Ecodesign ► pag. 084–085

► LED sources with direct power supply to the AC line voltage – driver not required. Dimmable with phase cut dimmer.  
 ► You can connect up to 4 Puzzle Mega to each fixture directly connected to the power supply. You can also connect up to 3 additional fixtures to each of those for maximum total of 36 fixtures on a single power outlet.

► LED con alimentazione diretta a tensione di rete – non necessita di driver. Dimmerabile con varialuce a taglio di fase.  
 ► Ad ogni Puzzle Mega connessa al punto di alimentazione elettrica possono esserne collegate altre 4. Ad ognuna di queste possono esserne collegate fino ad altre 3 e così via. Le lampade totali collegabili su un singolo punto di alimentazione sono 36.



# Puzzle Mega, design by Studio Italia Design, 2019

Accessory

## Puzzle Mega extension

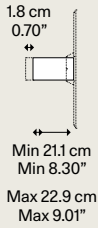

**Description**  
Descrizione

Extension optional  
Estensione opzionale

To be used to widen the light beam in case of ceiling installation

Da utilizzare per ampliare il fascio luminoso in caso di installazione a soffitto

**Metal structure**  
Montatura in metallo

● Matte White – 9016  
Bianco Opaco – 9016

Iva esclusa  
Vat excluded  
**Code**  
Codice **Euro €**

16799 A200 60,00

Net weight/Peso netto: 0.86 kg

Pack/Colli: 1

CE IP20

## Accessory connector



**Description**  
Descrizione

Connection  
Collegamento

To be used to connect the fixtures together in the compositions

Da utilizzare per collegare le lampade tra loro nelle composizioni

Iva esclusa  
Vat excluded  
**Code**  
Codice **Euro €**

16799 A100 35,00

Net weight/Peso netto: 0.10 kg

Pack/Colli: 1

CE IP20

Main power connection

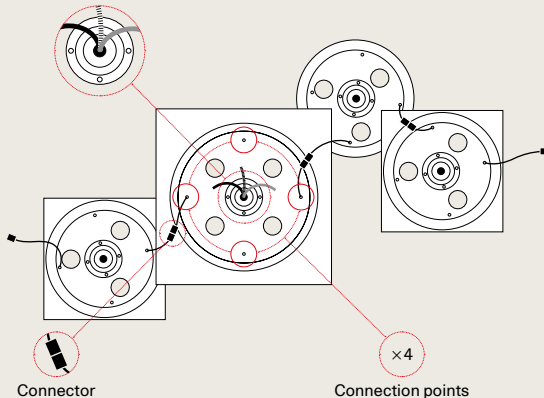

Min 11.7 cm – 4.60"  
Max 13.5 cm – 5.31"

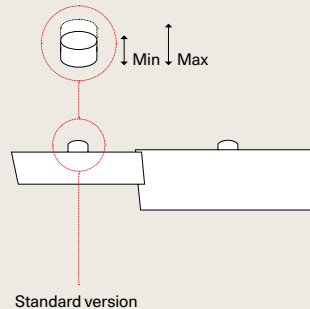

Standard version

Min 21.1 cm – 8.30"  
Max 22.9 cm – 9.01"

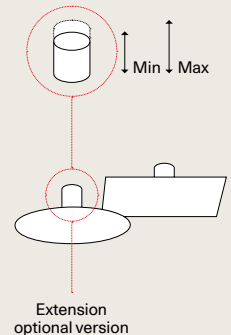

Extension optional version

► LED sources with direct power supply to the AC line voltage – driver not required. Dimmable with phase cut dimmer.  
► You can connect up to 4 Puzzle Mega to each fixture directly connected to the power supply. You can also connect up to 3 additional fixtures to each of those for maximum total of 36 fixtures on a single power outlet.

► LED con alimentazione diretta a tensione di rete – non necessita di driver. Dimmerabile con varialuce a taglio di fase.  
► Ad ogni Puzzle Mega connessa al punto di alimentazione elettrica possono esserne collegate altre 4. Ad ognuna di queste possono esserne collegate fino ad altre 3 e così via. Le lampade totali collegabili su un singolo punto di alimentazione sono 36.

Suspension lamp  
Cluster suspension lamp  
Canopy  
Wall & Ceiling lamp  
Floor & Table lamp  
Outdoor lamp  
Accessory

# Puzzle Round, design by Studio Italia Design, 2016

Wall lamp

Ceiling lamp

## Puzzle Round single

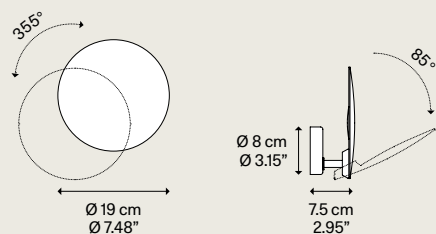

**Light source**  
Sorgente luminosa

**Metal structure**  
Montatura in metallo

Iva esclusa  
Vat excluded  
**Code**  
Codice **Euro €**

LED  
↘ 2700 K  
↘ 15 W/1750 lm  
↘ 220-240 V  
↘ CRI 92  
↘ MacAdam 3-Step

Matte White - 9016  
Bianco Opaco - 9016

15941 1027 215,00

Matte Black - 9005  
Nero Opaco - 9005

15941 2027 215,00

Copperty Bronze  
Bronzo Ramato

15941 3527 225,00

Champagne  
Champagne

15941 4527 225,00

or

Matte White - 9016  
Bianco Opaco - 9016

15941 1030 215,00

Matte Black - 9005  
Nero Opaco - 9005

15941 2030 215,00

Copperty Bronze  
Bronzo Ramato

15941 3530 225,00

Champagne  
Champagne

15941 4530 225,00

LED included  
LED incluso



Adjustable light  
Luce orientabile

Net weight/Peso netto: 0.6 kg

Pack/Colli: 1

Energy class/Classe energetica: F



IP20

Energy Saving

Dim Triac



## Puzzle Round double

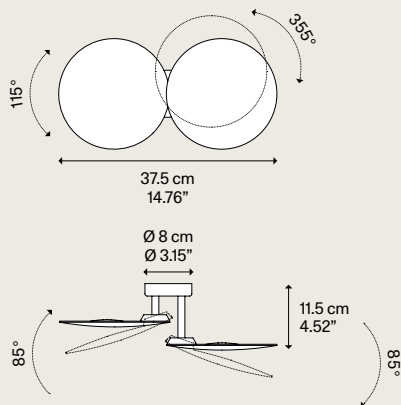

**Light source**  
Sorgente luminosa

**Metal structure**  
Montatura in metallo

Iva esclusa  
Vat excluded  
**Code**  
Codice **Euro €**

LED  
↘ 2700 K  
↘ 2 x 15 W/3500 lm  
↘ 220-240 V  
↘ CRI 92  
↘ MacAdam 3-Step

Matte White - 9016  
Bianco Opaco - 9016

15942 1027 395,00

Matte Black - 9005  
Nero Opaco - 9005

15942 2027 395,00

Copperty Bronze  
Bronzo Ramato

15942 3527 410,00

Champagne  
Champagne

15942 4527 410,00

or

Matte White - 9016  
Bianco Opaco - 9016

15942 1030 395,00

Matte Black - 9005  
Nero Opaco - 9005

15942 2030 395,00

Copperty Bronze  
Bronzo Ramato

15942 3530 410,00

Champagne  
Champagne

15942 4530 410,00

LED included  
LED incluso

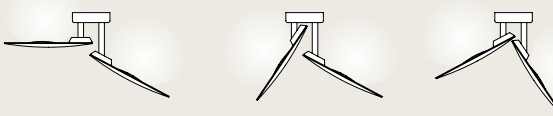

Adjustable light  
Luce orientabile

Net weight/Peso netto: 1.1 kg

Pack/Colli: 1

Energy class/Classe energetica: F



IP20

Energy Saving

Dim Triac



Ecodesign regulation ► pag. 084-085  
Regolamento di Ecodesign ► pag. 084-085

LED sources with direct power supply  
to the AC line voltage - driver not required.  
Dimmable with phase cut dimmer.

LED con alimentazione diretta a tensione  
di rete - non necessita di driver.  
Dimmerabile con varialuce a taglio di fase.

# Spider, design by Andrea Tosetto, 2022

Ceiling lamp

## Spider

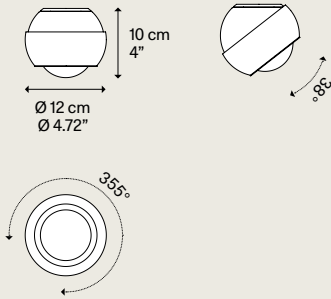

**Light source**  
Sorgente luminosa

**Metal structure**  
Montatura in metallo

**Metal diffuser**  
Diffusore in metallo

Iva esclusa  
Vat excluded  
**Code**  
Codice **Euro €**

LED  
 ↘ 2700 K  
 ↘ 10 W/920 lm  
 ↘ 220-240 V  
 ↘ CRI 90  
 ↘ MacAdam 3-Step

Chrome  
Cromo

Matte White - 9010  
Bianco Opaco - 9010

18340 1027 280,00

Matte Black - 9005  
Nero Opaco - 9005

18340 2027 280,00

Extra Matte Champagne  
Champagne Extra Opaco

18340 4527 295,00

Terra  
Terra

18340 6727 305,00

or

Matte White - 9010  
Bianco Opaco - 9010

18340 1030 280,00

Matte Black - 9005  
Nero Opaco - 9005

18340 2030 280,00

Extra Matte Champagne  
Champagne Extra Opaco

18340 4530 295,00

Terra  
Terra

18340 6730 305,00

LED included  
LED incluso



Adjustable light  
Luce orientabile

Net weight/Peso netto: 0.8 kg

Pack/Colli: 2

Energy class/Classe energetica: F



IP20

Energy Saving

Dim Triac



# Tidal, design by Needs Studio, 2023

Ceiling lamp

## Tidal NEW

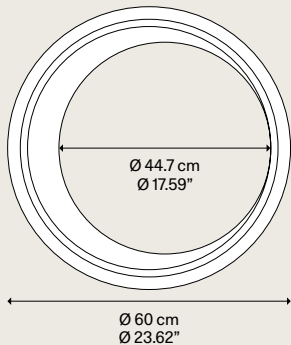

**Light source**  
Sorgente luminosa

**Metal structure**  
Montatura in metallo

Iva esclusa  
Vat excluded  
**Code**  
Codice **Euro €**

LED  
 ↘ 2700 K  
 ↘ 23.4 W/4680 lm  
 ↘ 350 mA  
 ↘ CRI 90  
 ↘ MacAdam 3-Step

Matte White - 9010  
Bianco Opaco - 9010

19930 1027 655,00

Matte Champagne  
Champagne Opaco

19930 4527 685,00

Terra  
Terra

19930 6727 715,00

or

LED  
 ↘ 3000 K  
 ↘ 23.4 W/4700 lm  
 ↘ 350 mA  
 ↘ CRI 90  
 ↘ MacAdam 3-Step

Matte White - 9010  
Bianco Opaco - 9010

19930 1030 655,00

Matte Champagne  
Champagne Opaco

19930 4530 685,00

Terra  
Terra

19930 6730 715,00

LED and driver  
included  
LED e driver inclusi

Net weight/Peso netto: 3.5 kg

Pack/Colli: 1

Energy class/Classe energetica: B



IP20

Energy Saving

Dim Triac



Ecodesign regulation ► pag. 084-085  
Regolamento di Ecodesign ► pag. 084-085

Suspension lamp  
Cluster suspension lamp  
Canopy  
Wall & Ceiling lamp  
Floor & Table lamp  
Outdoor lamp  
Accessory

# Volum, design by Snøhetta, 2023

Wall lamp

Ceiling lamp

## Volum 14 NEW

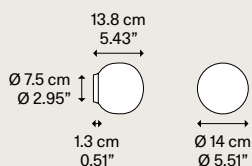

**Light source**  
Sorgente luminosa

E14 LED  
≈ 1 × 15 W

Ø max 5 cm – 1.96"  
W/L max  
9 cm – 3.54"

Bulb not included  
Lampadina non inclusa

**Silicone structure**  
Struttura in silicone

Translucent  
Traslucido

**Blown glass diffuser**  
Diffusore in vetro soffiato

Glossy White  
Bianco Lucido

**Code**  
Codice

18741 1200

Iva esclusa  
Vat excluded

**Euro €**  
160,00

Net weight/Peso netto: 0.74 kg

Pack/Colli: 2

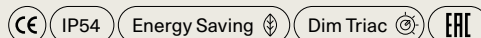

## Volum 22 NEW

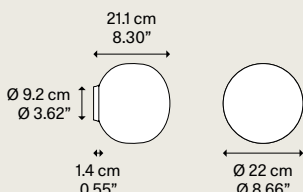

**Light source**  
Sorgente luminosa

E27 LED  
≈ 1 × 25 W

Ø max 5 cm – 1.96"  
W/L max  
12.5 cm – 4.92"

Bulb not included  
Lampadina non inclusa

**Silicone structure**  
Struttura in silicone

Translucent  
Traslucido

**Blown glass diffuser**  
Diffusore in vetro soffiato

Glossy White  
Bianco Lucido

**Code**  
Codice

18742 1200

Iva esclusa  
Vat excluded

**Euro €**  
250,00

Net weight/Peso netto: 1.15 kg

Pack/Colli: 2

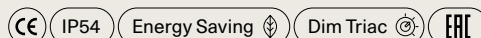

## Volum 29 NEW

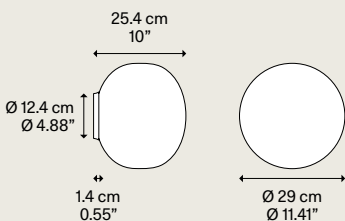

**Light source**  
Sorgente luminosa

E27 LED  
≈ 1 × 25 W

Ø max  
8.5 cm – 3.34"

Bulb not included  
Lampadina non inclusa

**Silicone structure**  
Struttura in silicone

Translucent  
Traslucido

**Blown glass diffuser**  
Diffusore in vetro soffiato

Glossy White  
Bianco Lucido

**Code**  
Codice

18743 1200

Iva esclusa  
Vat excluded

**Euro €**  
310,00

Net weight/Peso netto: 2.16 kg

Pack/Colli: 2

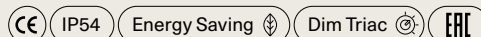

## Volum 42 NEW

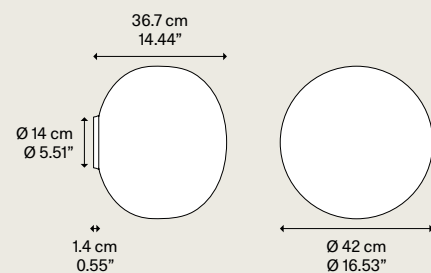

**Light source**  
Sorgente luminosa

E27 LED  
≈ 1 × 25 W

Ø max  
8.5 cm – 3.34"

Bulb not included  
Lampadina non inclusa

**Silicone structure**  
Struttura in silicone

Translucent  
Traslucido

**Blown glass diffuser**  
Diffusore in vetro soffiato

Glossy White  
Bianco Lucido

**Code**  
Codice

18744 1200

Iva esclusa  
Vat excluded

**Euro €**  
470,00

Net weight/Peso netto: 3.39 kg

Pack/Colli: 2

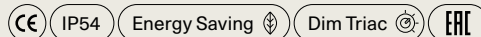

# Volum, design by Snøhetta, 2023

Wall lamp

## Volum mirror 14 NEW

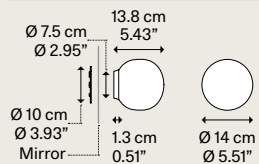

Net weight/Peso netto: 0.74 kg

Pack/Colli: 2

**Light source**  
Sorgente luminosa

E14 LED  
1 × 15 W

Ø max 5 cm - 1.96"  
W/L max  
9 cm - 3.54"

Bulb not included  
Lampadina non inclusa

**Silicone structure**  
Struttura in silicone

Translucent  
Traslucido

**Blown glass diffuser**  
Diffusore in vetro soffiato

Glossy White  
Bianco Lucido

**Code**  
Codice

18741 120S

Iva esclusa  
Vat excluded  
**Euro €**

200,00

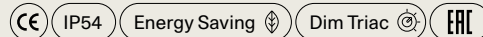

## Volum mirror 22 NEW

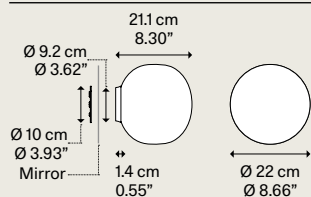

Net weight/Peso netto: 1.15 kg

Pack/Colli: 2

**Light source**  
Sorgente luminosa

E27 LED  
1 × 25 W

Ø max 5 cm - 1.96"  
W/L max  
12.5 cm - 4.92"

Bulb not included  
Lampadina non inclusa

**Silicone structure**  
Struttura in silicone

Translucent  
Traslucido

**Blown glass diffuser**  
Diffusore in vetro soffiato

Glossy White  
Bianco Lucido

**Code**  
Codice

18742 120S

Iva esclusa  
Vat excluded  
**Euro €**

290,00

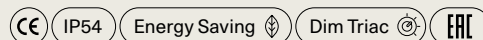

## Volum mirror 29 NEW

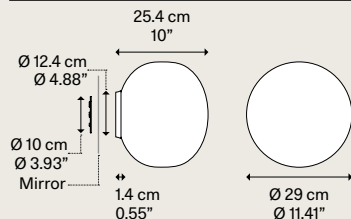

Net weight/Peso netto: 2.16 kg

Pack/Colli: 2

**Light source**  
Sorgente luminosa

E27 LED  
1 × 25 W

Ø max  
8.5 cm - 3.34"

Bulb not included  
Lampadina non inclusa

**Silicone structure**  
Struttura in silicone

Translucent  
Traslucido

**Blown glass diffuser**  
Diffusore in vetro soffiato

Glossy White  
Bianco Lucido

**Code**  
Codice

18743 120S

Iva esclusa  
Vat excluded  
**Euro €**

350,00

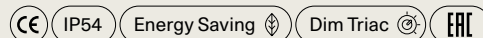

## Volum mirror 42 NEW

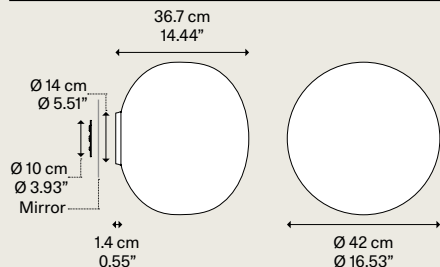

Net weight/Peso netto: 3.39 kg

Pack/Colli: 2

**Light source**  
Sorgente luminosa

E27 LED  
1 × 25 W

Ø max  
8.5 cm - 3.34"

Bulb not included  
Lampadina non inclusa

**Silicone structure**  
Struttura in silicone

Translucent  
Traslucido

**Blown glass diffuser**  
Diffusore in vetro soffiato

Glossy White  
Bianco Lucido

**Code**  
Codice

18744 120S

Iva esclusa  
Vat excluded  
**Euro €**

510,00

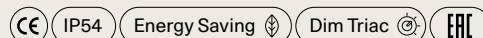

### Application Applicazione

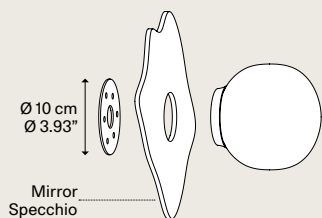

# Floor & Table lamps

## Floor lamps

---

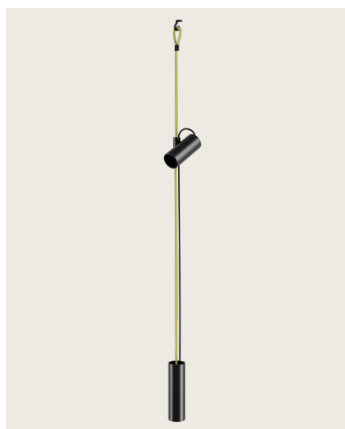

Cima  
Pag. 069



Croma  
Pag. 070

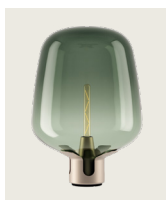

Flar  
Pag. 071

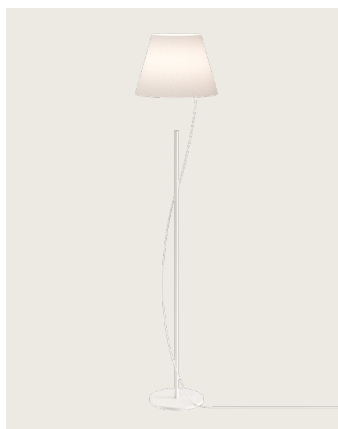

Hover  
Pag. 074

NEW LAMP

## Table lamps

---



Blow  
Pag. 072

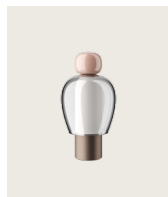

Easy Peasy  
Pag. 073



Flar  
Pag. 071



Hover  
Pag. 074

NEW LAMP



Volum  
Pag. 075

NEW LAMP

# Cima, design by Marco Dessí, 2021

Suspension lamp

Floor lamp

## Cima

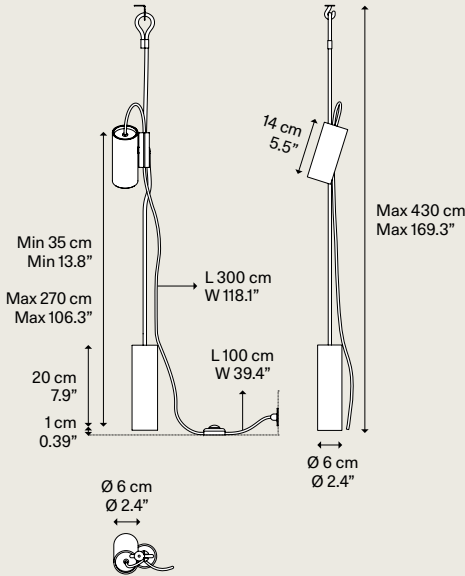

Light source Sorgente luminosa	Metal structure Montatura in metallo	Rope Corda	Code Codice	Iva esclusa Vat excluded Euro €
GU10 Par 16 LED ≈ 1 × 10 W	● Matte Black Nero Opaco	Silver Argento	17371 4100	285,00
W/L max 9 cm W/L max 3.54"		Gold Oro	17371 5000	285,00
		Yellow Giallo	17371 5100	285,00
Bulb and dimmer not included Lampadina e dimmer non inclusi				

Light source Sorgente luminosa	Description Descrizione	Metal structure Montatura in metallo	Code Codice	Iva esclusa Vat excluded Euro €
GU10 Par 16 LED ≈ 1 × 10 W	Additional kit max 2 spotlights	● Matte Black Nero Opaco	17371K2000	195,00
W/L max 9 cm W/L max 3.54"	Kit aggiuntivo max 2 spotlights			
Bulb and dimmer not included Lampadina e dimmer non inclusi				

Adjustable light  
Luce orientabile

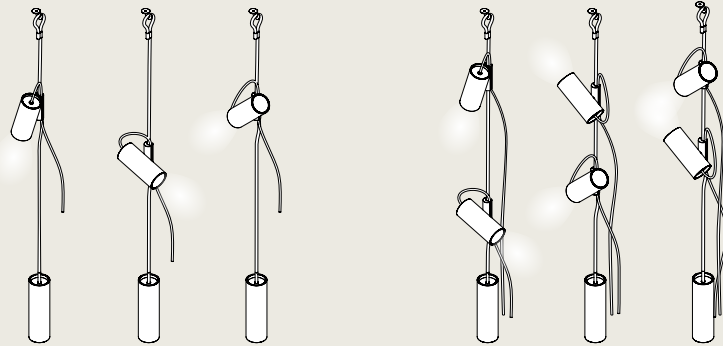

Net weight/Peso netto: 1.750 kg

Pack/Colli: 1



Suspension lamp

Cluster suspension lamp

Canopy

Wall & Ceiling lamp

Floor & Table lamp

Outdoor lamp

Accessory

# Croma, design by Luca Nichetto, 2021

Floor lamp



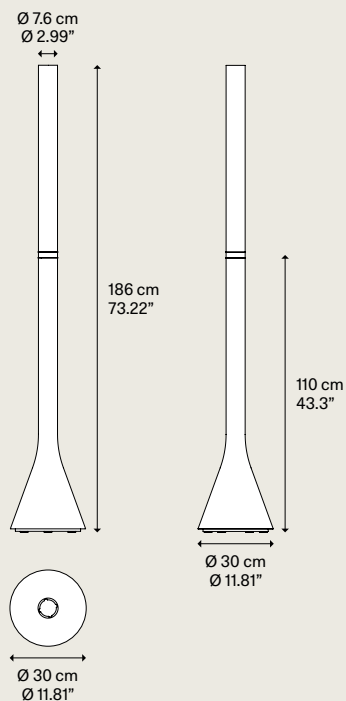

## Croma



### Light source Sorgente luminosa

LED  
 ▸ Dim-to-warm  
 from 2200 K  
 to 3200 K  
 ▸ 42 W/5600 lm  
 ▸ 220-240 V  
 ▸ CRI 90  
 ▸ MacAdam 3-Step

### Metal structure Montatura in metallo

- 
 Matte White - 9010  
 Bianco Opaco - 9010
- 
 Matte Black - 9005  
 Nero Opaco - 9005
- 
 Bronze  
 Bronzo
- 
 Green  
 Verde

### Code Codice

17270 1000	1450,00
17270 2000	1450,00
17270 3400	2210,00
17270 7000	2210,00

Iva esclusa  
Vat excluded

Euro €

### Dim-to-warm

▶ 20%	2200 K	1400 lm
▶ 40%	2600 K	2400 lm
▶ 60%	2850 K	3550 lm
▶ 80%	3000 K	4600 lm
▶ 100%	3200 K	5600 lm

LED, driver and Dim-to-warm dimmer included  
LED, driver e Dim-to-warm dimmer inclusi

Net weight/Peso netto: 15 kg

Pack/Colli: 1

Energy class/Classe energetica: E



Ecodesign regulation ▶ pag. 084-085  
 Regolamento di Ecodesign ▶ pag. 084-085



# Flar, design by Patrick Norguet, 2022

Table lamp

Floor lamp

## Flar medium

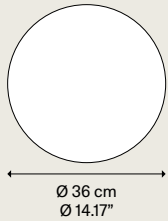
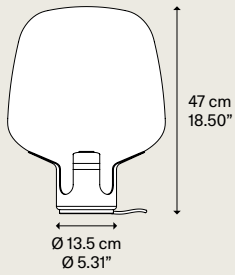

Net weight/Peso netto: 6.1 kg

Pack/Colli: 2

Light source  
Sorgente luminosa

E27 T30  
Tubular LED  
L/W 225 mm  
L/W 8.85"

⊃ 1 × 25 W

Bulb not included  
Dimmer on  
the cord included

Lampadina  
non inclusa  
Dimmer nel filo  
incluso

Metal structure  
Montatura in metallo

Champagne  
Champagne

Champagne  
Champagne

Terra  
Terra

Terra  
Terra

Blown glass diffuser  
Diffusore in vetro soffiato

Honey  
Miele

Turquoise  
Turchese

Honey  
Miele

Turquoise  
Turchese

Code  
Codice

19182 6800

19182 8600

19183 6800

19183 8600

Iva esclusa  
Vat excluded  
Euro €

890,00

890,00

1010,00

1010,00



## Flar large

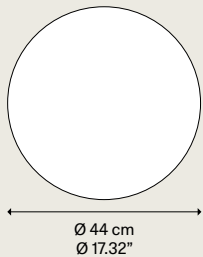
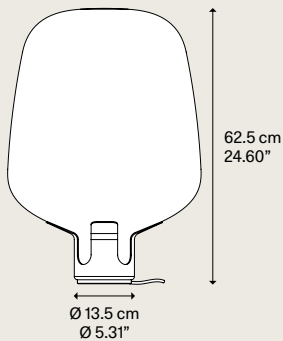

Net weight/Peso netto: 8 kg

Pack/Colli: 2

Light source  
Sorgente luminosa

E27 T30  
Tubular LED  
L/W 300 mm  
L/W 11.8"

⊃ 1 × 25 W

Bulb not included  
Dimmer on  
the cord included

Lampadina  
non inclusa  
Dimmer nel filo  
incluso

Metal structure  
Montatura in metallo

Champagne  
Champagne

Champagne  
Champagne

Terra  
Terra

Terra  
Terra

Blown glass diffuser  
Diffusore in vetro soffiato

Honey  
Miele

Turquoise  
Turchese

Honey  
Miele

Turquoise  
Turchese

Code  
Codice

19184 6800

19184 8600

19185 6800

19185 8600

Iva esclusa  
Vat excluded  
Euro €

1235,00

1235,00

1355,00

1355,00



Light source  
Sorgente luminosa

E27 T30  
⊃ 2500 K  
⊃ 6 W/620 lm

E27 T30  
⊃ 2500 K  
⊃ 7 W/800 lm

Dimension  
Dimensione

L/W 225 mm  
L/W 8.85"

L/W 300 mm  
L/W 11.8"

Pack  
Colli

1

1

Code  
Codice

191A02

191A03

Iva esclusa  
Vat excluded  
Euro €

30,00

35,00

# Blow, design by Pio & Tito Toso, 2005

Table lamp

## Blow

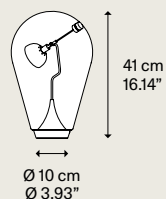

### Light source Sorgente luminosa

LED  
 > 2700 K  
 > 4.5 W / 500 lm  
 > 500 mA  
 > CRI 90  
 > MacAdam 3-Step

LED and driver included  
 LED e driver inclusi

### Metal structure Montatura in metallo

Chrome  
 Cromo

### Blown glass diffuser Diffusore in vetro soffiato

Clear  
 Trasparente

### Code Codice

00880 27

Iva esclusa  
 Vat excluded

Euro €  
 995,00

Adjustable light  
 Luce orientabile

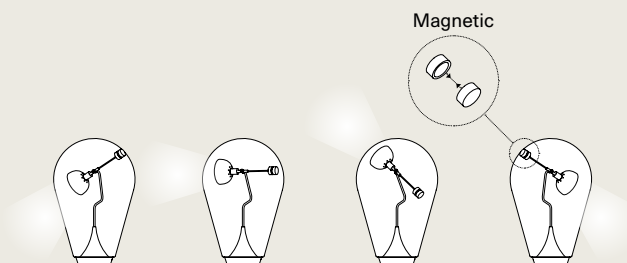

Net weight / Peso netto: 4.00 kg

Pack/Colli: 1

Energy class/Classe energetica: C

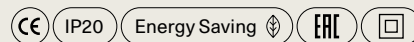

Ecodesign regulation ► pag. 084-085  
 Regolamento di Ecodesign ► pag. 084-085

# Easy Peasy, design by Luca Nichetto, 2020

Cordless table lamp

## Easy Peasy

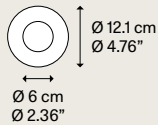
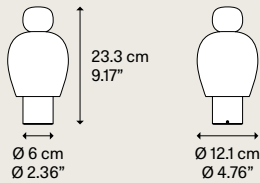

Light source Sorgente luminosa	Technopolymer knob Pomolo in tecnopolimero	Blown glass shade Cappello in vetro soffiato	Metal base Base in metallo	Code Codice	Iva esclusa Vat excluded Euro €
-----------------------------------	---	---	-------------------------------	----------------	---------------------------------------



### Flamingo

LED ↳ Dim-to-warm from 2700 K to 3300 K ↳ 3 W/380 lm ↳ 2000 mA Battery ↳ CRI 90 ↳ MacAdam 3-Step	 Pink Rosa	 Grey Grigio	 Brushed Bronze Spazzolato	17081 6226	260,00
---	--	--	---	------------	--------

LED and battery included  
LED e batteria inclusi

Iva esclusa  
Vat excluded

### Lagoon

LED ↳ Dim-to-warm from 2700 K to 3300 K ↳ 3 W/380 lm ↳ 2000 mA Battery ↳ CRI 90 ↳ MacAdam 3-Step	 Turquoise Turchese	 Honey Miele	 Brushed Gold Oro Spazzolato	17081 8126	260,00
---	---	--	--	------------	--------

LED and battery included  
LED e batteria inclusi

Iva esclusa  
Vat excluded

Net weight/Peso netto: 0.85 kg

Pack/Colli: 1

Energy class/Classe energetica: D

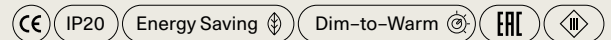

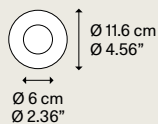
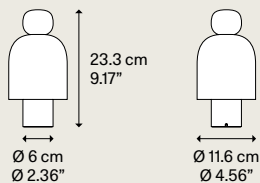

## Easy Peasy



Light source Sorgente luminosa	Technopolymer knob Pomolo in tecnopolimero	Blown glass shade Cappello in vetro soffiato	Metal base Base in metallo	Code Codice	Iva esclusa Vat excluded Euro €
-----------------------------------	---	---	-------------------------------	----------------	---------------------------------------

### Kelp

LED ↳ Dim-to-warm from 2700 K to 3300 K ↳ 3 W/380 lm ↳ 2000 mA Battery ↳ CRI 90 ↳ MacAdam 3-Step	 Green Verde	 Honey Miele	 Brushed Rose Gold Oro Rosa Spazzolato	17081 7226	260,00
---	--	--	--	------------	--------

LED and battery included  
LED e batteria inclusi

Iva esclusa  
Vat excluded

### Chestnut

LED ↳ Dim-to-warm from 2700 K to 3300 K ↳ 3 W/380 lm ↳ 2000 mA Battery ↳ CRI 90 ↳ MacAdam 3-Step	 Taupe Grigio Caldo	 Grey Grigio	 Brushed Palladium Palladio Spazzolato	17081 3826	260,00
---	---	--	--	------------	--------

LED and battery included  
LED e batteria inclusi

Iva esclusa  
Vat excluded

Net weight/Peso netto: 0.85 kg

Pack/Colli: 1

Energy class/Classe energetica: D

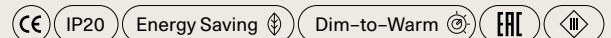

Ecodesign regulation ► pag. 084-085  
Regolamento di Ecodesign ► pag. 084-085

Battery charging time  
Tempo di ricarica

Power supply 1A ► 180 min

Battery life  
Durata batteria

Full power 100% ► 6h  
Half power 50% ► 10h  
Minimum power 10% ► 19h

# Hover, design by YOY, 2022

Floor lamp

## Hover NEW

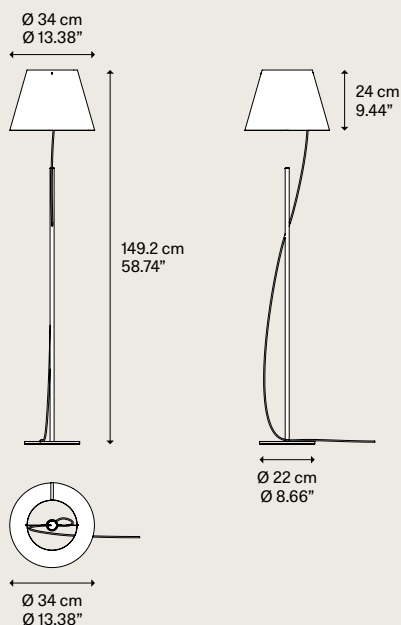

### Light source Sorgente luminosa

LED  
 ▷ 2700 K  
 ▷ 6 W / 1000 lm  
 ▷ 5V 2A  
 ▷ CRI 90  
 ▷ MacAdam 3-Step

### Metal structure Montatura in metallo

● Matte White  
Bianco Opaco

### Paper diffuser Diffusore in carta

● Matte White  
Bianco Opaco

### Code Codice

18471 1027

Iva esclusa  
Vat excluded  
Euro €

485,00

LED, driver and touch  
dimmer included  
LED, driver e touch  
dimmer inclusi

Net weight/Peso netto: 6 kg

Pack/Colli: 1

Energy class/Classe energetica: C

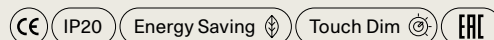
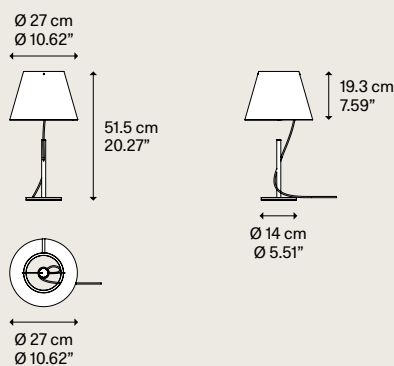

Table lamp

## Hover NEW



### Light source Sorgente luminosa

LED  
 ▷ 2700 K  
 ▷ 6 W / 1000 lm  
 ▷ 5V 2A  
 ▷ CRI 90  
 ▷ MacAdam 3-Step

### Metal structure Montatura in metallo

● Matte White  
Bianco Opaco

### Paper diffuser Diffusore in carta

● Matte White  
Bianco Opaco

### Code Codice

18480 1027

Iva esclusa  
Vat excluded  
Euro €

395,00

LED, driver and touch  
dimmer included  
LED, driver e touch  
dimmer inclusi

Net weight/Peso netto: 2.2 kg

Pack/Colli: 1

Energy class/Classe energetica: C

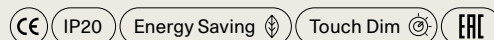

Touch dimmer

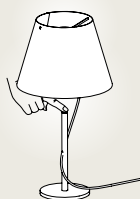

Ecodesign regulation ► pag. 084-085  
Regolamento di Ecodesign ► pag. 084-085

# Volum, design by Snøhetta, 2023

Table lamp

## Volum 14 NEW

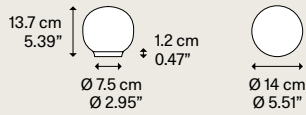

**Light source**  
Sorgente luminosa

E14 LED  
 1 × 15 W  
 Ø max 6 cm – 2.36"  
 W/L max 9 cm – 3.54"

Bulb not included  
 Lampadina non inclusa

**Silicone base**  
Base in silicone

Translucent  
 Traslucido

On/Off Switch the cord  
 Interruttore On/Off sul cavo

**Blown glass diffuser**  
Diffusore in vetro soffiato

Glossy White  
 Bianco Lucido

**Code**  
Codice

18781 1200

Iva esclusa  
 Vat excluded  
**Euro €**

165,00

E14 LED  
 1 × 15 W  
 Ø max 6 cm – 2.36"  
 W/L max 9 cm – 3.54"

Bulb not included  
 Lampadina non inclusa

Translucent  
 Traslucido

Dimmer switch on the cord  
 Interruttore con dimmer sul cavo

Glossy White  
 Bianco Lucido

18781 120D

235,00

Net weight/Peso netto: 0.71 kg

Pack/Colli: 2

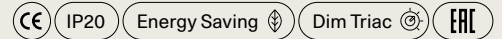

## Volum 22 NEW

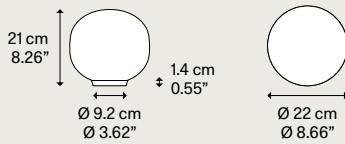

**Light source**  
Sorgente luminosa

E27 LED  
 1 × 25 W  
 Ø max 6 cm – 2.36"  
 W/L max 12.5 cm – 4.92"

Bulb not included  
 Lampadina non inclusa

**Silicone base**  
Base in silicone

Translucent  
 Traslucido

On/Off Switch the cord  
 Interruttore On/Off sul cavo

**Blown glass diffuser**  
Diffusore in vetro soffiato

Glossy White  
 Bianco Lucido

**Code**  
Codice

18782 1200

Iva esclusa  
 Vat excluded  
**Euro €**

255,00

E27 LED  
 1 × 25 W  
 Ø max 6 cm – 2.36"  
 W/L max 12.5 cm – 4.92"

Bulb not included  
 Lampadina non inclusa

Translucent  
 Traslucido

Dimmer switch on the cord  
 Interruttore con dimmer sul cavo

Glossy White  
 Bianco Lucido

18782 120D

325,00

Net weight/Peso netto: 1.19 kg

Pack/Colli: 2

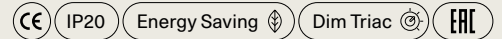

## Volum 29 NEW

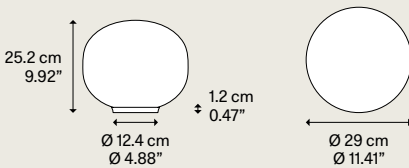

**Light source**  
Sorgente luminosa

E27 LED  
 1 × 25 W  
 Ø max 9.8 cm – 3.85"

Bulb not included  
 Lampadina non inclusa

**Silicone base**  
Base in silicone

Translucent  
 Traslucido

On/Off Switch the cord  
 Interruttore On/Off sul cavo

**Blown glass diffuser**  
Diffusore in vetro soffiato

Glossy White  
 Bianco Lucido

**Code**  
Codice

18783 1200

Iva esclusa  
 Vat excluded  
**Euro €**

320,00

E27 LED  
 1 × 25 W  
 Ø max 9.8 cm – 3.85"

Bulb not included  
 Lampadina non inclusa

Translucent  
 Traslucido

Dimmer switch on the cord  
 Interruttore con dimmer sul cavo

Glossy White  
 Bianco Lucido

18783 120D

390,00

Net weight/Peso netto: 2.06 kg

Pack/Colli: 2

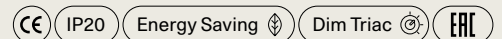

## Volum 42 NEW

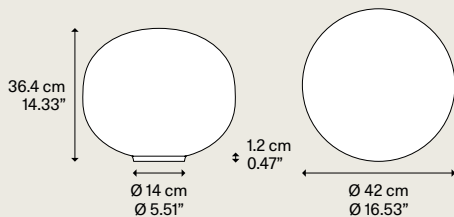

**Light source**  
Sorgente luminosa

E27 LED  
 1 × 25 W  
 Ø max 9.8 cm – 3.85"

Bulb not included  
 Lampadina non inclusa

**Silicone base**  
Base in silicone

Translucent  
 Traslucido

On/Off Switch the cord  
 Interruttore On/Off sul cavo

**Blown glass diffuser**  
Diffusore in vetro soffiato

Glossy White  
 Bianco Lucido

**Code**  
Codice

18784 1200

Iva esclusa  
 Vat excluded  
**Euro €**

480,00

E27 LED  
 1 × 25 W  
 Ø max 9.8 cm – 3.85"

Bulb not included  
 Lampadina non inclusa

Translucent  
 Traslucido

Dimmer switch on the cord  
 Interruttore con dimmer sul cavo

Glossy White  
 Bianco Lucido

18784 120D

550,00

Net weight/Peso netto: 3.34 kg

Pack/Colli: 2

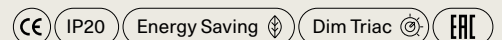

Suspension lamp

Cluster suspension lamp

Canopy

Wall & Ceiling lamp

Floor & Table lamp

Outdoor lamp

Accessory

# Outdoor lamp

Puzzle Outdoor, *design by* Studio Italia Design, 2019

Wall lamp

## Puzzle Outdoor single square

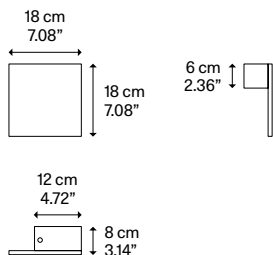

### Light source Sorgente luminosa

LED  
 ↗ 3000 K  
 ↗ 16 W/1700 lm  
 ↗ 220-240 V  
 ↗ CRI 92  
 ↗ MacAdam 3-Step

LED included  
 LED incluso

### Metal structure Montatura in metallo

● Matte White - 9016  
 Bianco Opaco - 9016  
 ● Anthracite Black  
 Nero Antracite

### Code Codice

14693 1030 245,00

14693 4430 245,00

Iva esclusa  
 Vat excluded

Net weight/Peso netto: 1.34 kg

Pack/Colli: 1

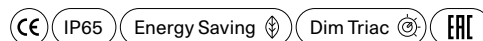

## Puzzle Outdoor double square

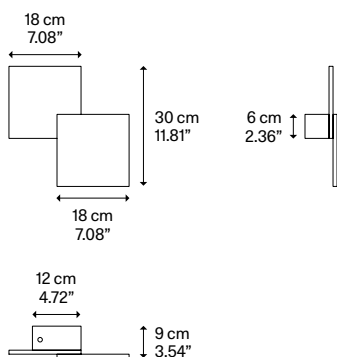

### Light source Sorgente luminosa

LED  
 ↗ 3000 K  
 ↗ 2 x 16 W/3400 lm  
 ↗ 220-240 V  
 ↗ CRI 92  
 ↗ MacAdam 3-Step

LED included  
 LED incluso

### Metal structure Montatura in metallo

● Matte White - 9016  
 Bianco Opaco - 9016  
 ● Anthracite Black  
 Nero Antracite

### Code Codice

14692 1030 385,00

14692 4430 385,00

Iva esclusa  
 Vat excluded

Net weight/Peso netto: 2.27 kg

Pack/Colli: 1

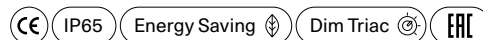

## Puzzle Outdoor square & rectangle

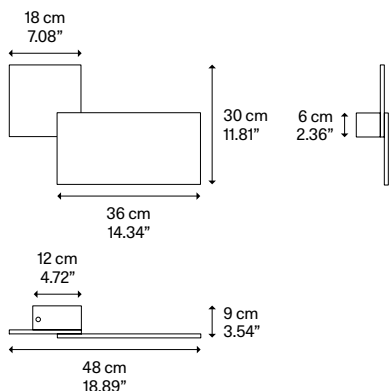

### Light source Sorgente luminosa

LED  
 ↗ 3000 K  
 ↗ 2 x 16 W/3400 lm  
 ↗ 220-240 V  
 ↗ CRI 92  
 ↗ MacAdam 3-Step

LED included  
 LED incluso

### Metal structure Montatura in metallo

● Matte White - 9016  
 Bianco Opaco - 9016  
 ● Anthracite Black  
 Nero Antracite

### Code Codice

14694 1030 440,00

14694 4430 440,00

Iva esclusa  
 Vat excluded

Net weight/Peso netto: 3.24 kg

Pack/Colli: 1

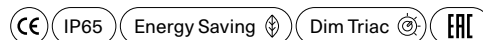

LED sources with direct power supply  
 to the AC line voltage - driver not required.  
 Dimmable with phase cut dimmer.

LED con alimentazione diretta a tensione  
 di rete - non necessita di driver.  
 Dimmerabile con varialuce a taglio di fase.

# Puzzle Outdoor, *design by Studio Italia Design, 2019*

Wall lamp

## Puzzle Outdoor round single

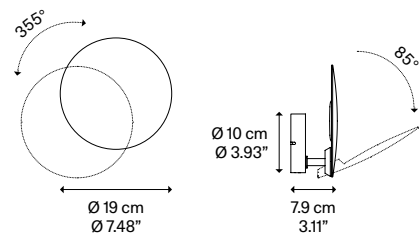

**Light source**  
Sorgente luminosa

LED  
 ↘ 3000 K  
 ↘ 16 W/1700 lm  
 ↘ 220-240 V  
 ↘ CRI 92  
 ↘ MacAdam 3-Step

LED included  
 LED incluso

**Metal structure**  
Montatura in metallo

● Matte White – 9016  
 Bianco Opaco – 9016  
 ● Anthracite Black  
 Nero Antracite

**Code**  
Codice

15991 1030

Iva esclusa  
 Vat excluded

**Euro €**  
270,00

15991 4430

280,00

Adjustable light  
 Luce orientabile

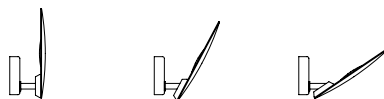

Net weight/Peso netto: 0.72 kg

Pack/Colli: 1

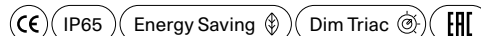

## Puzzle Outdoor round double

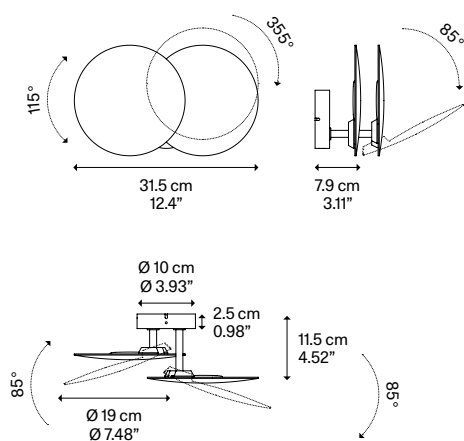

**Light source**  
Sorgente luminosa

LED  
 ↘ 3000 K  
 ↘ 2 x 16 W/3400 lm  
 ↘ 220-240 V  
 ↘ CRI 92  
 ↘ MacAdam 3-Step

LED included  
 LED incluso

**Metal structure**  
Montatura in metallo

● Matte White – 9016  
 Bianco Opaco – 9016  
 ● Anthracite Black  
 Nero Antracite

**Code**  
Codice

15992 1030

Iva esclusa  
 Vat excluded

**Euro €**  
490,00

15992 4430

490,00

Adjustable light  
 Luce orientabile

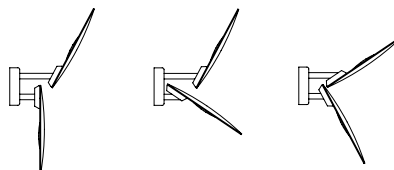

Net weight/Peso netto: 1.30 kg

Pack/Colli: 1

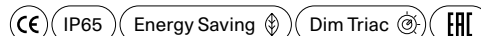

# Accessories

## Radial System

### Radial Swag Kit

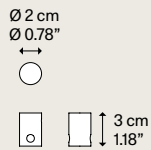

#### Description Descrizione

Wall and ceiling anchor for Radial System power cable max Ø 7 mm - 0.27" max capacity 5 kg

Cilindro di decentramento per Sistema Radiale cavo elettrico max Ø 7 mm - 0.27" Portata max 5 kg

#### Polycarbonate structure Struttura in policarbonato

● Clear  
Trasparente

#### System Sistema

Radial System

#### Code Codice

999A4 00

Iva esclusa  
Vat excluded

**Euro €**

**21,00**

Net weight/Peso netto: 0.02 kg

Pack/Colli: 1



## Accessory

### Back Plate Puzzle

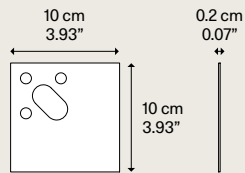

#### Description Descrizione

Optional backplate for Puzzle Wall and Ceiling

Piastra a muro opzionale per Puzzle Parete e Soffitto

#### Metal structure Montatura in metallo

● Matte White - 9016  
Bianco Opaco - 9016

#### System Sistema

Puzzle Series

#### Code Codice

14644 00

Iva esclusa  
Vat excluded

**Euro €**

**35,00**

Net weight/Peso netto: 0.07 kg

Pack/Colli: 1







## Accessory

## Kit 4 Lights Line



Description Descrizione	Metal structure Montatura in metallo	System Sistema	Code Codice	Iva esclusa Vat excluded
				Euro €
Extra Kit for decentralizing suspension with single power cable  Kit extra per decentrare sospensioni con cavo elettrico portante	 Matte White - 9010 Bianco Opaco - 9010	Line voltage cluster suspension lamps	999A00 1000	75,00
	 Matte Black - 9005 Nero Opaco - 9005		999A00 2000	75,00

Net weight/Peso netto: 0.37 kg

Pack/Colli: 1



## Accessory

## Kit Steel

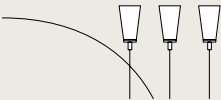

Description Descrizione	Metal structure Montatura in metallo	System Sistema	Code Codice	Iva esclusa Vat excluded
				Euro €
Extra Kit for decentralizing suspension with steel cable  Kit extra per decentrare sospensioni con funi d'acciaio	 Chrome Cromo	Kelly Series	999A01 4000	94,00

Net weight/Peso netto: 0.05 kg

Pack/Colli: 1



# DALI to TRIAC converter accessory

Iva esclusa  
Vat excluded

**Code**  
**Codice**

**Euro €**

999A02 120,00

Products	Number of products connectable to each accessory
► Puzzle Mega round large	3
► Puzzle Mega square large	3
► Bugia Triple	4
► Bugia Mega	4
► Puzzle Mega round small	4
► Puzzle Mega square small	4
► Bugia Double	6
► Nautilus (wall)	6
► Puzzle double square	6
► Puzzle square & rectangle	6
► Puzzle double round	6
► Elara	6
► Tidal	7
► Aile	12
► Bugia Single	13
► Kelly (wall)	12
► Laser	12
► Make-Up medium	12
► Make-Up large	12
► Nautilus (ceiling)	16
► Puzzle single square	12
► Puzzle single round	12
► Make-Up small	25
► Pin-Up	25
► Kelly Cluster	20
► Nautilus Spot	20
► Nostalgia	20
► Rain	20
► Spider	20
► Sky-Fall	12
► JIM	
► Kelly Dome	The wattage of the retrofit LED bulbs must not exceed 200W. Make sure to fit only dimmable bulbs.
► Kelly Sphere	La potenza delle lampadine LED retrofit non deve superare i 200W. Assicurarsi di montare solo lampadine dimmerabili.
► Volum	
► A-Tube	

# DALI + Push AC Phase Cut Dimmer

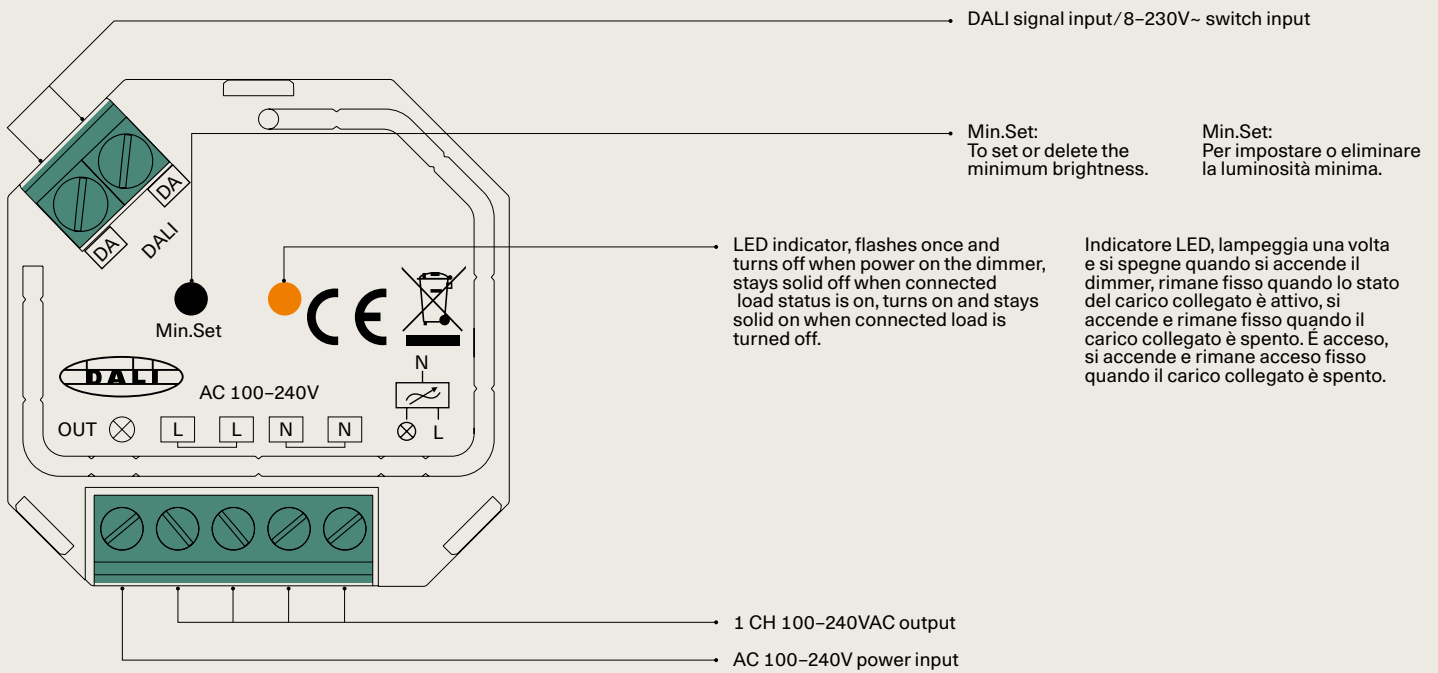





























Input Voltage	Output Voltage	Output Current	DALI Consumption	Size (L×W×H)
100-240VAC	100-240VAC	1.8A max	2mA max	45.5×45×20.3mm

Load Symbol	Load Type	Maximum Load	Remarks
	Dimmable LED lamps	200W @ 230V 100W @ 120V	Due to variety of LED lamp designs, maximum number of LED lamps is further dependent on power factor result when connected to dimmer.  A causa della varietà di modelli di lampade a LED, il numero massimo di lampade a LED dipende anche dal fattore di potenza ottenuto quando questi sono collegati al dimmer.
	Dimmable LED drivers	200W @ 230V 100W @ 120V	Maximum permitted number of drivers is 200W divided by driver nameplate power rating.  Il numero massimo consentito di driver è 200W diviso per la potenza nominale del driver.

**Attention: the performance of the dimmer is affected by possible interferences in the power supply network or by the presence of home automation systems. Always connect loads of the same type.**

**Attenzione: il funzionamento del dimmer è condizionato da eventuali disturbi presenti nella rete di alimentazione o dalla presenza di sistemi di domotica. Collegare sempre carichi dello stessa tipologia.**

## Extended dimming solutions for low-voltage products with remote driver (not included)

Products	Suggested driver			Type of dimming	Driver certification
<ul style="list-style-type: none"> <li>▶ Rain</li> <li>▶ Nostalgia</li> <li>▶ Spider (cluster suspension)</li> <li>▶ Kelly Cluster</li> </ul>	TCI Meanwell Meanwell	mod. ATON 30/250-700 DALI mod. LCM-40DA mod. LCM-40BLE	cod. 127370	DALI – PUSH DALI – PUSH CASAMBI – PUSH	   
<ul style="list-style-type: none"> <li>▶ Random Solo 12</li> <li>▶ Random Solo 14</li> <li>▶ Random Solo 18</li> </ul>	TCI Meanwell Meanwell	mod. ATON 30/250-700 DALI mod. LCM-40DA mod. LCM-40BLE	cod. 127370	DALI – PUSH DALI – PUSH CASAMBI – PUSH	   
▶ A-Tube Nano Duo	TCI Meanwell Meanwell	mod. ATON 30/250-700 DALI mod. LCM-40DA mod. LCM-40BLE	cod.127370	DALI – PUSH DALI – PUSH CASAMBI – PUSH	   
<ul style="list-style-type: none"> <li>▶ A-Tube Nano</li> <li>▶ IVY</li> <li>▶ Jefferson</li> <li>▶ Random Solo 23</li> <li>▶ Random Solo 28</li> </ul>	TCI Meanwell Meanwell	mod. ATON 30/250-700 DALI mod. LCM-40DA mod. LCM-40BLE	cod.127370	DALI – PUSH DALI – PUSH CASAMBI – PUSH	   
▶ Random	TCI Meanwell Meanwell	mod. ATON 30/250-700 DALI mod. LCM-40DA mod. LCM-40BLE	cod.127370	DALI – PUSH DALI – PUSH CASAMBI – PUSH	   
▶ Elara	Meanwell Meanwell	mod. LCM-40DA mod. LCM-40BLE		DALI – PUSH CASAMBI – PUSH	   
▶ Tidal	TCI Meanwell Meanwell	mod. ATON 30/250-700 DALI mod. LCM-40DA mod. LCM-40BLE	cod.127370	DALI – PUSH DALI – PUSH CASAMBI – PUSH	   

Driver VF (V)	Driver operational (MA)	LED power (W)	Lumen output (lm)	Max products series wiring
20	350	6,9	1281 1302	2 4 4
3	350	1	150 160	18 32 32
6	350	2	300 320	9 16 16
9	350	3	450 480	6 10 10 10 10
9	350	3	450 480	6 10 10
26,8	1050	28,1	2100 2260	1
46,8	500	23,4	4680	1

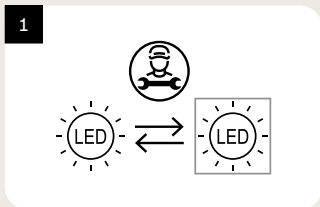

The LED-only light source contained in this fixture must only be replaced by the manufacturer, its support service or similarly qualified personnel. ● EN

La sorgente luminosa, esclusivamente LED, contenuta in questo apparecchio deve essere sostituita solo dal costruttore o dal suo servizio di assistenza o da personale altrettanto qualificato. ● IT

La source lumineuse, exclusivement à LED et contenue dans cet appareil, doit être remplacée uniquement par le fabricant ou par son service après-vente ou encore par un personnel tout aussi qualifié. ● FR

Das in diesem Geräte enthaltene Leuchtmittel, ausschließlich LED, darf nur vom Hersteller oder dessen Kundendienst oder vergleichbar qualifiziertes Personal ersetzt werden. ● DE

La fuente luminosa exclusivamente LED de este aparato la debe sustituir solamente el fabricante, el Servicio de Asistencia o personal igualmente cualificado. ● ES

Источник света, являющийся только светодиодом, который находится внутри этого светильника, должен заменяться только производителем или его службой поддержки или квалифицированным персоналом. ● RU

本照明设备中包含的全LED光源仅可由制造商、其协助服务部门或具备同等资质的合格人员进行更换。● ZH

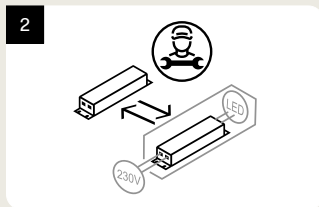

The LED driver contained in this fixture must only be replaced by the manufacturer, its support service or similarly qualified personnel. ● EN

Il driver LED contenuto in questo apparecchio deve essere sostituito solo dal costruttore o dal suo servizio di assistenza o da personale altrettanto qualificato. ● IT

Le driver à LED contenu dans cet appareil doit être remplacé uniquement par le fabricant ou par son service après-vente ou encore par un personnel tout aussi qualifié. ● FR

Der in diesem Gerät enthaltene LED-Treiber darf nur vom Hersteller oder dessen Kundendienst oder vergleichbar qualifiziertes Personal ersetzt werden. ● DE

El controlador led de este aparato lo debe sustituir solamente el fabricante, el Servicio de Asistencia o personal igualmente cualificado. ● ES

Привод светодиода, находящийся внутри этого светильника, должен заменяться только производителем или его службой поддержки или квалифицированным персоналом. ● RU

本照明设备中包含的led驱动器仅可由制造商、其协助服务部门或具备同等资质的合格人员进行更换。● ZH

Pag.	Product name (A-Z)	Category	Kelvin	Energy Class	Ecodesign Regulation
017	A-Tube Nano	Cluster suspension lamp	2700 K 3000 K	D	1 2
021	A-Tube Nano Duo	Cluster suspension lamp	2700 K	D	1 2
052	Aile	Wall lamp	2700 K 3000 K	E	1
072	Blow	Table lamp	2700 K	C	1 2
052	Bugia	Ceiling lamp	2700 K 3000 K	F	1
070	Croma	Floor lamp	from 2200 K to 3200 K	E	1 2
073	Easy Peasy	Cordless table lamp	from 2700 K to 3300 K	D	1
004	Elara	Suspension lamp	2700 K	D + E	1 2
004	Elara	Suspension lamp	3000 K	D + F	1 2
074	Hover	Floor lamp, Table lamp	2700 K	C	1
005 022	IVY	Cluster suspension lamp, Suspension lamp, Central cluster suspension lamp	2700 K	D	1 2
005 022	IVY	Cluster suspension lamp, Suspension lamp, Central cluster suspension lamp	3000 K	C	1 2
023	Jefferson	Cluster suspension lamp	2700 K	D	1 2
054	Kelly	Wall lamp	2700 K	F	1
026	Kelly Cluster	Cluster suspension lamp	2700 K	C	1 2
055	Laser	Wall lamp	2700 K 3000 K	F	1
056	Make-Up	Wall lamp, Ceiling lamp	3000 K	F	1
057	Nautilus	Wall lamp	2700 K 3000 K	F	1
057	Nautilus Mini	Wall lamp	2700 K 3000 K	G	1
058	Nautilus	Ceiling lamp	2700 K 3000 K	F	1
058	Nautilus Spot	Ceiling lamp	2700 K 3000 K	F	1
027	Nostalgia	Cluster suspension lamp	2700 K	C	1 2
059	Pin-Up	Wall lamp, Ceiling lamp	2700 K 3000 K	E	1
060	Puzzle	Wall lamp, Ceiling lamp	2700 K 3000 K	F	1
061	Puzzle Mega	Wall lamp, Ceiling lamp	2700 K 3000 K	F	1
064	Puzzle Round	Wall lamp, Ceiling lamp	2700 K 3000 K	F	1
030	Rain	Cluster suspension lamp	2700 K 3000 K	C	1 2
032	Random	Cluster suspension lamp	2700 K 3000 K	D	1 2
033	Random Solo	Cluster suspension lamp	2700 K 3000 K	D	1 2
008	Sky-Fall	Suspension lamp	2700 K 3000 K	E	1 2
038	Spider	Cluster suspension lamp	2700 K 3000 K	C	1 2
065	Spider	Ceiling lamp	2700 K 3000 K	F	1
065	Tidal	Ceiling lamp	2700 K 3000 K	B	1 2

**Art. 1 Recital**  
Unless otherwise provided for in a separate written agreement between the parties, every sale of products of Lodes S.r.l., VAT 02992370276 (hereinafter, "the Seller") is governed by the following General Conditions of Sale that must be considered as an essential part of this agreement and shall be deemed to have been accepted by the Buyer even though the latter has not signed them. Any clause unilaterally added by the Buyer in the documentation signed by it and / or in its correspondence, being against or in any case in addition to the general conditions or to those specific expressly approved in writing by the Seller, shall be deemed as not written and shall be of no effect.

**Art. 2 Completion of the sale, quantities and prices**  
The sale is deemed to be completed once the Seller gives the written order confirmation also by fax and / or email or when deliveries are commenced in cases where the immediate delivery of the supply is requested, also in consideration of changes occurred and then accepted by the customer. The prices agreed are understood for products delivered ex works of the Seller and do not include services and accessory charges (such as VAT, special packaging, transport and installation costs, and / or assemblages and so on).

**Art. 3 Delivery, risk transfer and transport**  
Products are delivered to the Buyer at the Seller's plant or at another place indicated in writing by the Seller, and the risk transfer takes place with the delivery of the goods to the first carrier or Buyer in the events of collection of goods directly carried out by the latter. The products always travel at the Buyer's sole risk also when the carrier is selected and appointed by the Seller, being the latter freed from all responsibilities after having delivered the products to the carrier, this delivery is deemed to all effects being carried out directly by the said Buyer. The delivery terms agreed are to be understood as indicative. If the Seller is responsible for delay of delivery for a period of up to 60 days, the Buyer is not entitled either to refuse the supply or to request the termination of the agreement and / or the compensation for any damages. If the delay in delivery exceeds 60 days, the Buyer is entitled to request – by registered letter – the cancellation of the order and the reimbursement of the advances if paid. In any event, the Seller shall not be liable for and / or direct and indirect damages of any nature and for any reason due to the delay or the failure to carry out the supply.

**Art. 4 Reservation of title**  
The Buyer acquires property rights over the goods with the full payment of the price invoiced of the supplies but it takes the risks thereof as of the delivery.

**Art. 5 Products features and conditions of use**  
Unless otherwise expressly agreed in writing by the parties, the conditions for using of the products are those communicated or in any case resulting from the drawings and technical specifications of the Seller, if any, or as described in the website [www.lodes.com/en/in](http://www.lodes.com/en/in) relation to products. The quality levels of products are the standard quality levels of the Sellers, indicated in the relevant specifications as described on the Seller's website. It is always the Buyer's responsibility to identify and notify the Seller of the conditions of use of products before technically defining them. Failing any particular instructions from the Buyer, the Seller considers as usual conditions of use those it considered or described in its designs and technical documentation.

**Art. 6 Warranties**  
The products delivered are covered by a warranty for defects in material and manufacture for a period of 24 months as of the delivery if the Buyer is a natural person, otherwise the warranty period will be of 12 months as of the delivery. The Seller shall replace

the products delivered in this warranty period being faulty due to factory defects or in alternative, at its discretion, pay the Buyer an amount equal to the price already invoiced of the said products, being expressly excluded and waived any other right or claim by the Buyer also as compensation for direct and / or indirect damages or cost repayment borne by it (such as recovery, technical assistance, recalling costs, etc.). The Seller will anticipate the delivery of the replaced product, invoicing it regularly. Successively, when the product arrive to the Seller's warehouse, the latter will credit the amount of the defective product. The transport's costs will be paid by the Seller. Should the defected item be returned in an inadequate non-original packaging, with damages connected to the transport, The Seller will not credit any amount to the Buyer, and it will return the product to the sender at his own expenses. If the replacement was made for alleged defects in material and manufacture, but after the control carried out by the Seller, it is considered (i) unfounded, due to the absence of defects; (ii) further damaged by insufficient packaging in the return transport (iii) spoiled by tampering made by the Buyer, all transportation costs and the entire value of the product will be charged to the latter. Any defectiveness or non-compliance of products shall be reported by the Buyer by writing to the Seller – in order to be valid – within 8 days from receipt of goods; any hidden defects shall be reported by the Buyer by writing to the Seller – always in order to be valid – within 8 days as of the relevant discovery. It being understood that the Seller will not be responsible for any defect even though hidden, being notified in writing, after 24 months of the delivery of goods. The warranty does not apply where the defects identified are due to the Buyer's negligence and / or to the use of products being not compliant with the information and explanations in any case gave by the Seller, technical provisions, to incorrect design, application, assembly or manufacture of the facilities in which they are installed, to incorrect maintenance carried out by unauthorized personnel, to improper cleaning since it is made with materials and manners being not suitable, to incorrect storage, handling and transport, to improper or imprudent use, also in the event of electrical system and its capacity being not suitable, or to circumstances that in any case cannot be related to the production defectiveness by the Seller. Every single product of the Seller corresponds to the mark laid down by the European Community with Directive 93 / 68 (extension of Directive 73 / 23) to confirm, with a mark recognized all over Europe, that the lights have undergone the electrical safety test required by European standards EN-60598-1-2 II ed. + CEI EN 60598-1 IV ed. corresponding to Italian standards CEI 34-21 + CEI 34-23, electrical safety standards referred to by all institutions, including the IMQ. The products indicated with the logo UL and / or ETL corresponds to the standards UL 1598 / CAN / USA C22.2 No.250.0 o UL 153.

**Art. 7 Buyer's Obligations**  
The Buyer is required to immediately take delivery of the goods given by the Seller to the carrier, or – where otherwise agreed – to timely collect them at the Seller's plant on the date on which the Seller communicates, by any means, that the goods are ready. Where the Buyer delays the collection of the production for a period exceeding 10 days, in addition to the payment of price it shall pay the Seller a proper compensation equal to 2% per day of the price invoiced for storing such products. The Buyer shall carry out the payments normally, in accordance with the terms and conditions specified in the invoice. For late payments it will be accrued by default without need of further notification interest under Legislative Decree no. 231 / 2002. In the event of payment delays, the Seller is entitled to immediately suspend any supply, even though it has concluded other agreements with the same Buyer. The failure to pay within the terms agreed will cause in any event the loss of favourable terms for the Buyer.

**Art. 8 Replacement of the Product**  
If a product is returned for commercial reasons or for a mistake in the order made by the Buyer, the Seller will retain an amount equal to the 20% of the total price as cost for reconditioning the product. If the returned product had already been used and / or it has been returned in an inadequate original packaging, with consequent transport damages, the Seller will not credit to the Buyer any amount and it will return the product to the sender at his own expenses. Only the articles in the catalogue and in the price list in force at the time of the request will be taken into consideration. Transport's costs are always charged to the Buyer. The repair of damaged products will be authorized only if the damage has been caused by the Buyer. The Buyer, once accepted repair costs, will take care of returning the damaged product to the Seller's warehouse and it will pay the costs of transporting the repaired product.

**Art. 9 Force majeure**  
If the Seller is unable to comply with the agreement due to force majeure or beyond its control events, the deadlines set for the supply are automatically extended for a period in which these effects continue. Where the obstacle to comply with the agreement is longer than 6 months, both parties may request the termination of the agreement and, in such event, the Seller repay the Buyer the advances received, if any, releasing itself from any additional obligation on it.

**Art. 10 Agreement**  
In the event of execution of a specific agreement signed by the parties, the said agreement together with its Annexes provides for and summarizes the obligations validly undertaken by the parties and being binding for them. The fulfilment by the parties will be subject to effective evaluation of the actual performance of the contractual tasks and duties to be carried out in good faith, with honesty and fairness. These General Conditions of Sale shall apply to the agreement, unless otherwise provided in writing by the parties or expressly provided in the said agreement.

**Art. 11 Privacy Policy**  
The Seller will use the data received from the Buyer in accordance with the provisions of the article 13 of EU Regulation 2016 / 679 of 27 April 2016 (GDPR). For more information are available at the following link: [www.lodes.com/en/terms-and-conditions/](http://www.lodes.com/en/terms-and-conditions/).

**Art. 12 Disputes**  
Any dispute which may arise concerning the signing, validity, interpretation, performance, amendment and termination of the agreement or of these General Conditions of Sale will be settled according to principles and rule set forth in Article 13 below.

**Art. 13 Jurisdiction and Applicable Law**  
The Court of Milan, Italy, shall be held exclusively competent, being any other court of competent jurisdiction expressly excluded, and the Italian Law shall be applicable.

**Art. 14 Website**  
These General Conditions of Sale are those indicated on the website [www.lodes.com/en/](http://www.lodes.com/en/) and may be printed and reproduced on paper. The Seller undertakes to update the website [www.lodes.com/en/](http://www.lodes.com/en/) by publishing on it the version of the General Conditions of Sale as amended from time to time.



#### Art. 1 Premessa

Salvo deroga risultante da apposito accordo scritto tra le parti, ogni compravendita di prodotti di Lodes S.r.l., P.IVA 02992370276 (di seguito: "Venditore") è regolata dalle seguenti Condizioni Generali di Vendita che costituiscono parte essenziale del contratto e che si intendono pertanto accettate dal Compratore ancorché dallo stesso non sottoscritte. Qualsiasi clausola unilateralmente apposta dal Compratore nei documenti da lui sottoscritti e/o nella sua corrispondenza, che sia contraria o comunque in aggiunta alle seguenti condizioni generali od a quelle speciali espressamente approvate per iscritto dal Venditore, si intende come non scritta ed è priva di ogni effetto.

#### Art. 2 Perfezionamento della compravendita, quantitativi e prezzi

La compravendita si intende perfezionata con la conferma d'ordine scritta del Venditore anche a mezzo fax/e/posta elettronica o con l'inizio delle consegne per i casi in cui è stata richiesta l'immediata consegna della fornitura anche in presenza di modifiche intervenute e quindi accettate dal cliente. I prezzi concordati si intendono per prodotti consegnati franco stabilimento del Venditore e non comprendono prestazioni ed oneri accessori (quali IVA, imballo speciale, spese di trasporto, di installazione e/o montaggi e così via).

#### Art. 3 Consegna, trasferimento del rischio e trasporto

La merce viene consegnata al Compratore presso lo stabilimento del Venditore o in altro sito dallo stesso indicato per iscritto, ed il trasferimento del rischio avviene con la consegna della stessa al primo vettore o al Compratore nelle ipotesi di ritiro della merce da quest'ultimo direttamente eseguita. La merce viaggia sempre a rischio esclusivo del Compratore anche quando il vettore dovesse essere scelto ed incaricato dal Venditore, essendo quest'ultimo liberato da ogni responsabilità con la consegna dei prodotti al vettore, che ad ogni effetto si intende eseguita a mani dallo stesso Compratore. I termini di consegna pattuiti si intendono indicativi. In caso di ritardo nella consegna imputabile al Venditore per un periodo fino a 60 gg il Compratore non ha il diritto di rifiutare la fornitura, né di richiedere la risoluzione del contratto e/o il risarcimento di alcun danno. Se il ritardo nella consegna supera il termine di 60 gg il Compratore ha la facoltà di richiedere - con lettera raccomandata - l'annullamento dell'ordine e la restituzione degli anticipi eventualmente versati. Resta in ogni caso escluso qualsivoglia obbligo del Venditore di risarcimento danni diretti e/o indiretti di qualsiasi natura e per qualsiasi ragione, in dipendenza del ritardo ovvero della mancata esecuzione della fornitura.

#### Art. 4 Riserva di proprietà

Il Compratore acquista la proprietà della merce solo con il pagamento integrale del prezzo fatturato delle forniture ma ne assume i rischi dal momento della consegna.

#### Art. 5 Caratteristiche dei prodotti e condizioni di utilizzo

Salvo diverso ed espresso accordo scritto tra le parti, i parametri funzionali dei prodotti sono quelli espressi comunicati o comunque risultanti nei disegni e specifiche tecniche del Venditore se esistenti o su quanto indicato sul sito web [www.lodes.com](http://www.lodes.com) relativamente ai prodotti. I livelli di qualità dei prodotti forniti sono quelli standard del Venditore, evidenziati nelle relative specifiche o su quanto indicato e desumibile sul sito web del Venditore. È onere del Compratore individuare e comunicare al Venditore le condizioni di utilizzo dei prodotti prima della relativa definizione tecnica. In mancanza di indicazioni da parte del Compratore il Venditore considera condizioni di utilizzo quelle di prassi dallo stesso considerate o esplicitate nei propri disegni e documentazione tecnica.

#### Art. 6 Garanzie

I prodotti forniti sono coperti da garanzia per difetti di materiale e/o fabbricazione per un periodo di 24 mesi dalla consegna se il Compratore risulta essere una persona fisica, diversamente il periodo di garanzia sarà di 12 mesi dalla consegna. Il Venditore sostituisce i prodotti resi in detto periodo di garanzia e riconosciuti difettosi per vizi d'origine ovvero in alternativa ed a sua scelta accredita al Compratore una somma pari al prezzo già fatturato dei prodotti stessi, restando espressamente escluso e rinunciato qualsiasi diverso diritto o pretesa del Compratore anche a titolo di risarcimento danni diretti e/o indiretti o di rimborso di costi dallo stesso sostenuti (quali costo di riprese, di assistenza tecnica, di richiamo, ecc.). Il Venditore anticiperà l'invio del prodotto in sostituzione, fatturandolo regolarmente, andando poi ad accreditare l'importo alla riconsegna del prodotto difettoso reso. Le spese di trasporto saranno a carico del Venditore. Qualora l'articolo oggetto del reso venisse riconsegnato in un imballo non originale inadeguato con conseguenti danni da trasporto, il Venditore non accrediterà al Compratore alcun importo e rinvierà al mittente, a sue spese il prodotto. Qualora il reso venisse effettuato per presunti vizi d'origine ma dopo il controllo effettuato dal Venditore lo stesso venisse ritenuto (i) infondato, per assenza di vizi; (ii) ulteriormente danneggiato da insufficiente imballaggio nel trasporto di ritorno (iii) viziato da manomissione posta in essere dal Compratore, verranno addebitati a quest'ultimo tutti i costi di trasporto nonché l'intero valore del prodotto. Eventuali difettosità o non conformità dei prodotti devono essere segnalate dal Compratore per iscritto al Venditore - a pena di decadenza - entro e non oltre 8 gg dalla data di ricevimento della merce; eventuali difetti occulti devono essere segnalati dal Compratore per iscritto al Venditore - sempre a pena di decadenza - entro 8 gg dalla relativa scoperta. Resta inteso che il Venditore non sarà responsabile per alcun vizio ancorché occulto, comunicato per iscritto, oltre 24 mesi dalla consegna della merce. La garanzia non opera ove i difetti rilevati siano imputabili a negligenza del Compratore e/o ad impiego dei prodotti non conforme con le informazioni e le spiegazioni in ogni caso fornite dal Venditore, alle prescrizioni tecniche, ad errata progettazione, applicazione, montaggio o fabbricazione delle strutture ove sono installati, ad errata manutenzione operata da personale non autorizzato, a pulizia impropria in quanto effettuata con modalità o materiali non idonei, ad errato magazzino, movimentazione e trasporto, ad uso improprio ed incauto, anche in caso di impianto elettrico e portata dello stesso non idonea, ovvero a circostanze che comunque non possono ricollegarsi a difettosità di produzione da parte del Venditore. Ogni singolo prodotto del Venditore è conforme alla marcatura richiesta dalla Comunità Europea con la direttiva 93/68 (ampliamento della direttiva 73/23) per confermare con una marcatura riconosciuta in tutta Europa, che le lampade sono state sottoposte alle prove di sicurezza elettrica richieste dalle norme Europee EN-60598-1-2 II ed. + CEI EN 60598-1 IV ed. corrispondenti norme italiane CEI 34-21 + CEI 34-23, norme per la sicurezza elettrica a cui fanno riferimento tutti gli istituti, compreso l'IMQ. I prodotti indicati con il marchio UL e/o ETL sono conformi alla normativa UL 1598/CAN/USA C22.2 No.250.0 o UL 153.

#### Art. 7 Obblighi del Compratore

Il Compratore è tenuto a prendere immediatamente in consegna i prodotti affidati dal Venditore al vettore, ovvero - se diversamente concordato - a puntualmente ritirarli presso lo stabilimento del Venditore alla data di comunicazione di merce pronta che potrà avvenire con ogni mezzo da parte del Venditore. Ove il Compratore ritardi il ritiro dei prodotti per un periodo superiore a 10 gg, oltre al pagamento del prezzo deve corrispondere al Venditore un adeguato compenso pari al 2% al giorno dell'importo fatturato per il magazzino degli stessi. Il Compratore deve effettuare i pagamenti normalmente, con le modalità e nei termini precisati in fattura. Sui ritardati pagamenti decorreranno, di pieno diritto e senza necessità di costituzione in mora, gli

interessi di cui al D.lgs. n. 231/2002. In caso di ritardo dei pagamenti il Venditore ha diritto a sospendere immediatamente ogni fornitura, anche se dipendente da altri contratti con lo stesso Compratore. Il mancato pagamento nei termini pattuiti comporta in ogni caso la decadenza del Compratore dal beneficio del termine.

#### Art. 8 Resi

In caso di reso commerciale o in caso di reso per errore del Compratore, il Venditore tratterà un importo pari al 20% minimo del totale a titolo di costo di ricondizionamento dell'articolo. Qualora l'articolo oggetto del reso fosse già stato utilizzato e/o venisse riconsegnato in un imballo non originale inadeguato, con conseguenti danni da trasporto, il Venditore non accrediterà al Compratore nessun importo e rinvierà al mittente, a sue spese, il reso. Verranno presi in considerazione solamente gli articoli presenti nel catalogo e nel listino in vigore al momento della richiesta. Le spese di trasporto sono sempre a carico del Compratore. I resi per riparazione vanno autorizzati solo se la causa del danno è dipesa dal Compratore che dopo aver accettato il costo di riparazione si occuperà a proprie spese di rispedire l'articolo danneggiato in sede e si accollerà poi i costi relativi al trasporto del prodotto riparato.

#### Art. 9 Forza maggiore

Qualora il Venditore sia impossibilitato a rispettare il contratto per cause di forza maggiore o comunque indipendenti dalla sua volontà, i termini previsti per l'esecuzione della fornitura sono automaticamente prorogati per un periodo equivalente al perdurare degli effetti di tali cause. Qualora la causa impeditiva continui per più di 6 mesi entrambe le parti possono chiedere la risoluzione del contratto ed in tal caso il Venditore restituisce al Compratore gli anticipi eventualmente ricevuti, con esclusione di ogni e qualsiasi onere ulteriore a suo carico.

#### Art. 10 Contratto

In caso di sottoscrizione di apposito contratto lo stesso con i suoi allegati contiene e riassume le obbligazioni validamente assunte dalle parti e per esse vincolanti. L'adempimento delle parti sarà oggetto di valutazione dell'effettiva esecuzione dei compiti e doveri contrattuali, da effettuarsi in buona fede, onestà e con equità. Le presenti Condizioni Generali di Vendita si applicheranno al contratto salvo deroga risultante da atto scritto o in esso contratto esplicitamente prevista.

#### Art. 11 Trattamento dei Dati Personali

Il Venditore utilizzerà i dati ricevuti dal Compratore conformemente alle disposizioni vigenti in materia di Privacy secondo l'art. 13 del Regolamento Europeo 2016 / 679 (GDPR). Maggiori informazioni sono disponibili al seguente link: [www.lodes.com/area-legale/](http://www.lodes.com/area-legale/).

#### Art. 12 Controversie

Qualora dovesse verificarsi una qualsivoglia controversia avente ad oggetto la formazione, validità, interpretazione, esecuzione, modifica e risoluzione del contratto o delle presenti Condizioni Generali di Vendita, questa sarà risolta secondo i principi e le regole indicate nell'articolo 13 che segue.

#### Art. 13 Foro competente e legge applicabile

Foro esclusivamente competente sarà quello di Milano con esplicita esclusione di ogni altro foro alternativamente competente, e la legge applicabile quella italiana.

#### Art. 14 Sito Web

Le presenti Condizioni Generali di Vendita, sono quelle risultanti sul sito web [www.lodes.com](http://www.lodes.com) e sono stampabili e riproducibili su supporto cartaceo. Il Venditore si impegna ad aggiornare il sito web [www.lodes.com](http://www.lodes.com) mediante la pubblicazione sullo stesso della versione di Condizioni Generali di Vendita di volta in volta modificata.

Head offices & showroom

Lodes, via Pialoi 32,  
30020 Marcon (Venezia) Italy  
T +39 041 45 69 266  
General information  
info@lodes.com

Lodes USA LLC  
560 Springfield Avenue,  
Suite B – Westfield,  
NJ 07090 – USA  
D 201 903 0020  
usa@lodes.com

Lodes Milan showroom

via della Moscova 33,  
Cortile della Seta  
20121 Milano (MI) Italy  
T +39 02 4940 0999  
milano@lodes.com



