

Kdl*n*'s light vibrates with emotion and takes shape. Unusual associations between the past and the contemporary give life to original projects that speak a universal language but are always unique. Each lamp is reminiscent of its inspiration; it is the story of a research on materials and techniques. A multifaceted world of luminous objects that meet the most diverse needs and desires in domestic settings and public spaces.

**EN: Light, according to Kdln, is poetry and beauty, functionality and technique, simplicity and character. A universal language, a unique and versatile style, that draws on the past in an interpretation that is original and contemporary. From domestic to contract, each project is consistent with the company's identity. Key values: attention to quality, reliability and concreteness. Together with an out-of-the-box creativity that Kdln shares with established designers as well as with emerging talents.**

**IT:** La luce secondo Kdln è poesia e bellezza, funzionalità e tecnica, semplicità e carattere. Un linguaggio universale, uno stile unico e versatile, che attinge al passato in una lettura originale e contemporanea. Dal domestico al contract, ogni progetto è coerente con l'identità dell'azienda. Valori chiave: attenzione alla qualità, affidabilità e concretezza. Insieme a una creatività fuori dagli schemi che Kdln condivide con designer affermati e talenti emergenti.

**FR:** La lumière, selon Kdln est poésie et beauté, fonctionnalité et technique, simplicité et caractère. Un langage universel, un style unique et polyvalent, qui puise dans le passé dans une lecture originale et contemporaine. Du résidentiel au contract, chaque projet est cohérent avec l'identité de l'entreprise. Les valeurs-clés : attention à la qualité, fiabilité et caractère concret. Avec une créativité hors des sentiers battus que Kdln partage avec des designers confirmés et des talents émergents.

**D:** Für Kdln ist Licht Poesie und Schönheit, Funktionalität und Technik, Schlichtheit und Charakter. Eine universelle Sprache, ein einzigartiger und vielseitiger Stil, der sich in einer originellen und zeitgenössischen Interpretation auf die Vergangenheit stützt. Vom Wohnbereich bis hin zum Contract-Bereich steht jedes Projekt im Einklang mit der Identität des Unternehmens. Schlüsselwerte: besonderes Augenmerk auf die Qualität, Zuverlässigkeit und Konkretheit. Gemeinsam mit einer unkonventionellen Kreativität, die Kdln mit etablierten Designern und aufstrebenden Talenten teilt.

**ES:** La luz según Kdln es poesía y belleza, funcionalidad y técnica, simplicidad y carácter. Un lenguaje universal, un estilo único y versátil, que recurre al pasado en una lectura original y contemporánea. Desde el doméstico al contract, cada proyecto es coherente con la identidad de la empresa. Valores clave: atención a la calidad, confiabilidad y concreción. Junto a una creatividad fuera de los esquemas que Kdln comparte con diseñadores establecidos y talentos emergentes.

# FLOOR

p. 14



**EVITA**  
p. 14



**E.T.A.**  
p. 15



**FLOOR**  
p. 16



**KUSHI FLOOR**  
p. 17



**KUSHI XL FLOOR**  
p. 18

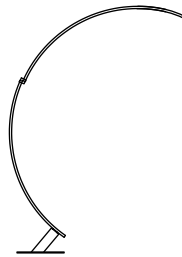

**KYUDO**  
p. 19



**OPYO FLOOR**  
p. 20

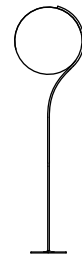

**POISE FLOOR**  
p. 21



**SHAKTI**  
p. 22



**SPILLO FLOOR**  
p. 23



**SPILLO OUTDOOR**  
p. 24

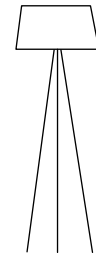

**TRIPOD FLOOR**  
p. 25



**TYLA**  
p. 26

# TABLE

p. 27

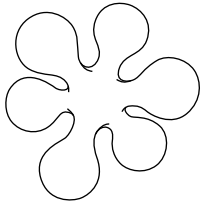

**ATOMIUM**  
p. 27

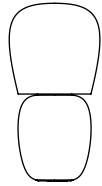

**HIVE**  
p. 28



**KUSHI MOBILE**  
p. 29

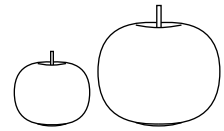

**KUSHI TABLE**  
p. 30-31

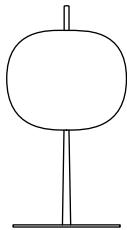

**KUSHI XL TABLE**  
p. 32

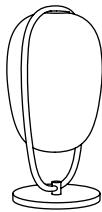

**LANNÀ TABLE**  
p. 33

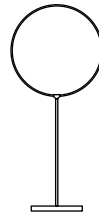

**POISE**  
p. 34



**TATU**  
p. 35

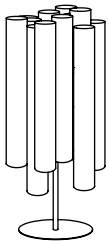

**TOOT TABLE**  
p. 36

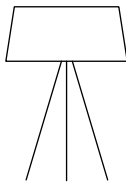

**TRIPOD TABLE**  
p. 37

# SUSPENSION

p. 38

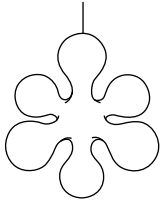

**ATOMIUM CEILING**  
p. 46

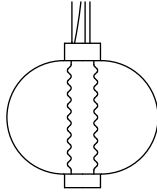

**BOLHA**  
p. 47

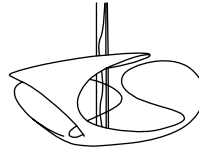

**CLOVER**  
p. 48

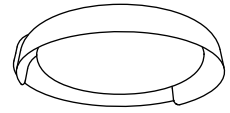

**DALA**  
p. 49

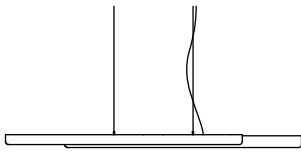

**DALA LINEAR**  
p. 50

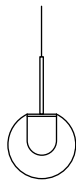

**DEW**  
p. 51-52

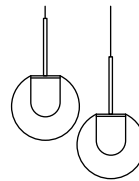

**DEW CHANDELIER**  
p. 53-57



**E.T.A. SAT**  
p. 58

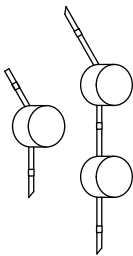

**FLOED**  
p. 59-60

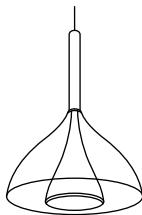

**FLOOB CEILING**  
p. 61

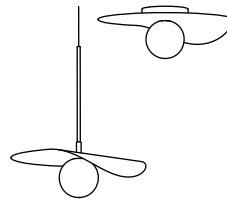

**FLOW**  
p. 62-63

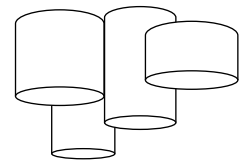

**GIASS**  
p. 64-67



**JER**  
p. 68

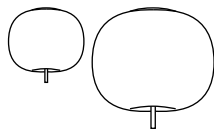

**KUSHI CEILING**  
p. 69-71

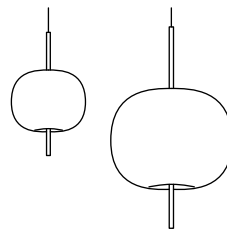

**KUSHI SUSPENSION**  
p. 72-74



**LANNÀ SUSPENSION**  
p. 75



**LILLI**  
p. 76

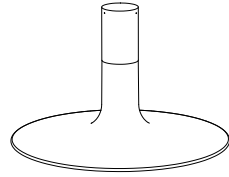

**LOUIS**  
p. 77



**MINIMAL**  
p. 78

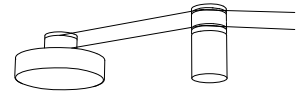

**MITOS**  
p. 79

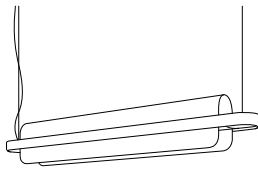

**NAMI**  
p. 80

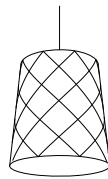

**NEW YORK**  
p. 81

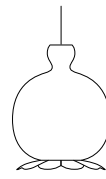

**OPYO SUSPENSION**  
p. 82

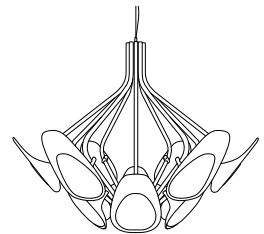

**PEACOCK**  
p. 83

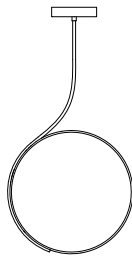

**POISE CEILING**  
p. 84



**SPILLO CEILING**  
p. 85

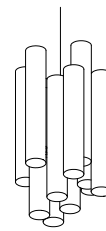

**TOOT SUSPENSION**  
p. 86

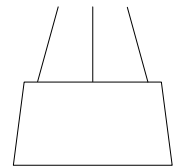

**TRIPOD CEILING**  
p. 87

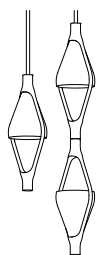

**VICEVERSA**  
p. 88-89



**YUMA**  
p. 90

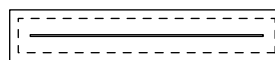

**LINEAR CANOPY**  
p. 38-41

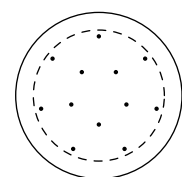

**ROUND CANOPY**  
p. 42-45

# WALL

p. 91

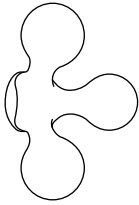

**ATOMIUM WALL**

p. 91

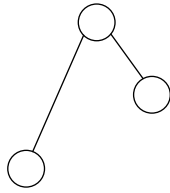

**AZOU**

p. 92-94



**EVITA WALL**

p. 95

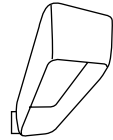

**FRAME**

p. 96

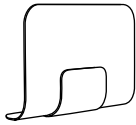

**NAMI WALL**

p. 97

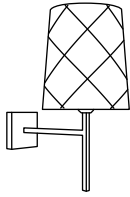

**NEW YORK WALL**

p. 98

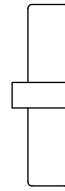

**PASTILLA**

p. 99

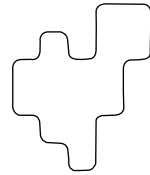

**PIXEL**

p. 100

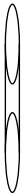

**SHAKTI WALL**

p. 101

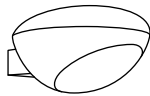

**TUA**

p. 102

# ACCESSORIES

p. 103

# FAMILY COLLECTION

ATOMIUM p. 27  
ATOMIUM CEILING p. 46  
ATOMIUM WALL p. 91

DALA p. 49  
DALA LINEAR p. 50

DEW p. 51  
DEW 3 p. 52  
DEW CHANDELIER p. 53-57

EVITA p. 14  
EVITA WALL p. 95

E.T.A. p. 15  
E.T.A. SAT p. 58

FLOOB p. 16  
FLOOB CEILING p. 61

FLOW p. 62  
FLOW CEILING p. 63

KUSHI FLOOR p. 17  
KUSHI XL FLOOR p. 18  
KUSHI 16 MOBILE p. 29  
KUSHI 16 TABLE p. 30  
KUSHI 33 TABLE p. 31  
KUSHI XL TABLE p. 32  
KUSHI 16 CEILING p. 69  
KUSHI 33 CEILING p. 70  
KUSHI XL CEILING p. 71  
KUSHI 16 SUSPENSION p. 72  
KUSHI 33 SUSPENSION p. 73  
KUSHI XL SUSPENSION p. 74

LANNÀ TABLE p. 33  
LANNÀ SUSPENSION p. 75

NAMI p. 80  
NAMI WALL p. 97

NEW YORK 33 p. 81  
NEW YORK 45 p. 81  
NEW YORK WALL p. 98

OPYO FLOOR p. 20  
OPYO SUSPENSION p. 82

POISE FLOOR p. 21  
POISE p. 34  
POISE CEILING p. 84

SHAKTI 200 p. 22  
SHAKTI 250 p. 22  
SHAKTI WALL FIX 80 p. 101

SPILLO FLOOR p. 23  
SPILLO OUTDOOR FIX p. 24  
SPILLO OUTDOOR FLOOR p. 24  
SPILLO OUTDOOR PEG p. 24  
SPILLO CEILING p. 85  
SPILLO OUTDOOR CEILING p. 85

TOOT TABLE p. 36  
TOOT SUSPENSION p. 86

TRIPOD FLOOR p. 25  
TRIPOD TABLE p. 37  
TRIPOD CEILING p. 87



# TECHNICAL INFO

## GLOSSARY

bulbs . lampadine . ampoules . Leuchtmittel . bombillas  
cable length . lunghezza cavo . longueur de câble . Kabellänge . longitud del cable  
canopy . rosone . rosace . Baldachin . plafón  
certifications . certificazioni . certifications . Zertifizierungen . certificaciones  
colours . colori . couleurs . Farben . colores  
code . codice . code . Artikelnummer . código  
description . descrizione . description . Beschreibung . descripción  
dimensions . dimensioni . dimensions . Größe . dimensiones  
dimmable . dimmerabile . dimmable . dimmbar . regulable  
dimmer . dimmer . variateur . Dimmer . dimmer  
feeding . alimentazione . alimentation . Spannung . tensión de red  
finish . finitura . finitions . Oberflächen . acabados  
materials . materiali . matériaux . Materialien . materiales  
packaging . imballo . emballage . Verpackung . embalaje  
price vat excl. . prezzo iva esc. . prix ht . Preis ohne MwSt . precio iva excluida

## LIGHT DIRECTION



Direct and indirect lighting  
Luce diretta e indiretta  
Lumière directe et indirecte  
Direktes und indirektes Licht  
Luz directa y indirecta



Indirect lighting  
Luce indiretta  
Lumière indirecte  
Indirektes Licht  
Luz indirecta



Direct lighting  
Luce diretta  
Lumière directe  
Direktes Licht  
Luz directa



Indirect and spot lighting  
Luce indiretta e spot  
Lumière indirecte et spot  
Indirektes und fokussiertes Licht  
Luz indirecta y puntual



Direct and spot lighting  
Luce diretta e spot  
Lumière directe et spot  
Direktes und fokussiertes Licht  
Luz directa y puntual



Diffused lighting  
Luce diffusa  
Lumière diffuse  
Verbreitetes Licht  
Luz difusa



acid-etched brass  
ottone acidato  
laiton acide  
satinierter Bronzefarbe  
latón acidificado



amber  
ambra  
Bernstein  
ámbar



black  
nero  
noir  
Schwarz  
negro



black marble  
marmo nero  
marbre noir  
schwarz Marmor  
mármol negro



black nickel  
nichel nero  
nickel noir  
schwarzes Nickel  
níquel negro



black tin  
stagno nero  
étain noir  
schwarzem Zinn  
estaño negro



\* brass  
ottone  
laiton  
Messing  
latón



bronze  
bronzó  
bronce  
Bronze  
bronce



chrome  
cromo  
chrome  
Chrom  
cromado



\*\* copper  
rame  
cuivre  
Kupfer  
cobre



coral  
corallo  
corail  
Koralle  
coral



dark blue  
blu scuro  
bleu foncé  
dunkel Blau  
azul oscuro



dark grey + concrete finish  
grigio scuro + finitura cemento  
gris foncé + finition ciment  
dunkel Grau + Zementoberfläche  
gris oscuro + acabado de cemento



dark grey + copper  
grigio scuro + rame  
gris foncé + cuivre  
dunkel Grau + Kupfer  
gris oscuro + cobre



dark grey + wood finish  
grigio scuro + finitura legno  
gris foncé + finition bois  
dunkel Grau + Holzoberfläche  
gris oscuro + acabado de madera



dove-grey  
grigio tortora  
gris tourterelle  
Taubengrau  
gris paloma



green onyx  
onice verde  
onyx vert  
grüner Onyx  
ónix verde



grey chrome  
grigio cromato  
gris chromé  
Chromgrau  
gris cromado



ecrù  
ecrù  
écru  
Écru  
ecru



mixed colours  
colori misti  
couleurs mélangées  
gemischte Farben  
colores mezclados



moka  
moka  
moka  
Mokka  
moka



orange  
arancione  
orange  
Orange  
naranja



red  
rosso  
rouge  
Rot  
rojo



sand + copper  
sabbia + rame  
sable + cuivre  
Sand + Kupfer  
arena + cobre



sand + concrete  
sabbia + cemento  
sable + ciment  
Sand + Zement  
arena + cemento



sand + wood  
sabbia + legno  
sable + bois  
Sand + Holz  
arena + madera



smokey blue  
blu fumè  
bleu fumé  
rauch Blau  
azul ahumado



smokey brown  
marrone fumè  
marron foncé  
rauch Braun  
marrón ahumado



smokey green  
verde fumè  
vert fumé  
rauch Grün  
verde ahumado



smokey grey  
grigio fumè  
gris fumé  
Rauchgrau  
gris ahumado



transparent  
trasparente  
transparent  
durchsichtig  
transparente



warm white  
bianco caldo  
blanc chaud  
Warmweiß  
blanco roto



white  
bianco  
blanc  
Weiß  
blanco



white marble  
marmo bianco  
marbre blanc  
weiss Marmor  
mármol blanco

\* 111 powder coating . verniciatura a polvere . revêtement en poudre . Pulverbeschichtung . recubrimiento en polvo  
205 . 209 . 219 liquid painting . verniciatura a liquido . peinture liquide . Nasslackierung . pintura líquida, 305 . 307 plated . galvanico . plaqué . galvanisch . chapado

\*\* 212 . 221 liquid painting . verniciatura a liquido . peinture liquide . Nasslackierung . pintura líquida, 304 plated . galvanico . plaqué . galvanisch . chapado

## CODES

**EN.** The codes in this price list are referred to devices with voltage feeding 220-240 V and are produced according to the standards in compliance with **CE** directives.

Where the abbreviation / GB is mentioned it states the possibility to order devices with plug adaptor suitable for the UK market (type G, standard IEC). The devices without plug do not require any different fitting from **CE** standard for being used in the UK market.

**IT.** I codici riportati in questo listino si riferiscono ad apparecchi funzionanti con tensioni di alimentazione a 220- 240 V realizzati secondo gli standard in conformità alle direttive comunitarie **CE**.

Ove presente la sigla / GB si indica la possibilità di ordinare apparecchi dotati di spine adatte per il mercato UK (tipo G, standard IEC). Gli apparecchi non dotati di spina non richiedono allestimenti diversi dagli standard **CE** per essere utilizzati nel mercato UK.

**FR.** Les codes dans ce tarif font référence aux luminaires à tension 220-240 V uniquement, qui sont fabriqués en conformité des normes **CE**.

Le paraphe / GB signale la possibilité de commander des lampes sur pied avec des fiches appropriées pour le marché britannique (type G, standard IEC). Les appareils sans fiches sont utilisables en Grande Bretagne sans modifications par rapport aux standards **CE**.

**D.** Die in dieser Preisliste aufgeführten Artikelnummer beziehen sich auf Geräte mit der Versorgungsspannung von 220-240 V, die unter der Einhaltung des **CE** Standards hergestellt wurden.

Die Abkürzung / GB ermöglicht die Bestellung der Geräte mit den Steckern, die für den britischen Markt (Typ G, Standard IEC) bestimmt sind. Geräte ohne Stecker erfordern für den britischen Markt keine besondere Ausrüstung, die unterschiedlich vom **CE** Standard ist.

**ES.** Los códigos que aparecen en esta tarifa, se refieren a aparatos que funcionan con tensión de alimentación a 220-240 V realizados según los standards con conformidad a las directivas comunitarias de la **CE**.

Donde esté presente las siglas / GB se indica la posibilidad de pedir aparatos dotados de enchufe adaptado para el mercado UK (tipo G, standard IEC). Los aparatos que no están dotados con enchufe no necesitan complementos diversos a los estándares **CE** para ser utilizados en el mercado UK.

## NOTES

**EN.** Goods delivery have to be considered Ex Factory.

Goods are carefully and accurately packaged, Kdln S.r.l. declines all responsibilities for any damage caused by the transport.

All merchandise is shipped at the dealer's risk, even if free of carriage.

Any claim related to apparent and occult defects has to be communicated to Kdln by mail or fax within 8 days from the date of receipt of the goods.

Kdln reserves the right to alter any of the above conditions, at its own discretion and without notice.

Suspension lamps are supplied with 180 cm (70.9 in) long cables. Different lengths can be produced on demand. The company reserves the right to change the design of the canopies and the cable length without notice.

The dimmability of suspension and wall lamps with E27 (E26) and E14 (E12) bulb sockets depends on the dimmability of the chosen light source.

Product colors can differ from what is shown in the catalogue and from batch to batch.

The listed light emission in Lumen is nominal.

For any disputes the involved Forum is Milan (Italy).

**IT.** La merce si intende franco fabbrica.

La merce è attentamente e accuratamente imballata, Kdln S.r.l. declina ogni responsabilità per danni causati dal trasporto.

La merce viaggia a rischio e pericolo del committente, anche se spedita in porto franco.

Reclami per difetti apparenti ed occulti devono essere comunicati via mail o fax entro 8 giorni dal ricevimento della merce.

Kdln si riserva il diritto di modificare qualsiasi delle suddette condizioni, a propria discrezione e senza alcun preavviso.

Le lampade a sospensione sono dotate di cavi lunghi 180 cm (70.9 in).

Eventuali misure diverse possono essere prodotte su richiesta. La società si riserva comunque il diritto di variare il disegno dei rosoni e la lunghezza dei cavi senza alcun preavviso.

La dimmerabilità delle lampade a sospensione e delle lampade da parete con attacco E27 (E26) e E14 (E12) dipende dalla dimmerabilità della sorgente luminosa scelta.

I colori dei prodotti possono variare rispetto a quanto rappresentato nel catalogo e da lotto a lotto.

I lumen indicati sono da considerarsi nominali.

Per qualsiasi controversia sarà competente il Foro di Milano, Italia.

**FR.** La marchandise est livrée à la condition 'départ usine'.

Toutes les marchandises voyagent aux risques et périls du revendeur, même si elles sont rendues franco de port.

Les réclamations pour défauts apparents et occultes doivent être notifiés par mail ou fax dans les 8 jours suivant la réception de la marchandise.

Kdln se réserve le droit de modifier n'importe laquelle des clauses précédentes sans préavis, en fonction de ses exigences.

Les lampes à suspension sont équipées de câbles d'une longueur de 180 cm (70.9 in). D'éventuelles autres mesures peuvent être produites sur demande. La société se réserve toutefois le droit de modifier le dessin des rosettes et la longueur des câbles sans aucun préavis.

La variation de lumière des suspensions et appliques E27 (E26) et E14 (E12) dépend de la source lumineuse choisie.

Les couleurs des produits peuvent varier par rapport à ce qui est présenté dans le catalogue ainsi que de lot à lot.

Les lumens indiqués s'entendent nominaux.

Le Tribunal de Milan (Italie) sera le seul compétent pour toutes contestations.

**D.** Die Ware wird ab Werk verkauft.

Die Ware wird sorgfältig und gründlich verpackt. Kdln S.r.l. lehnt jegliche Haftung für Transportschäden ab.

Sämtliche Waren werden auf Risiko und Gefahr des Einzelhändlers transportiert, auch im Falle von Verschickung frei Bestimmungsort.

Jegliche Reklamationen der Waren müssen innerhalb von 8 Tagen nach Erhalt der Lieferung per Post oder Fax mitgeteilt werden.

Kdln behält sich das Recht vor, alle oben genannten Bedingungen nach eigenem Ermessen und ohne vorherige Ankündigung zu ändern. Die Hängelampen verfügen über 180 cm (70.9 in) lange Kabel.

Andere Längen können auf Anfrage hergestellt werden. Das Unternehmen behält sich in jedem Falle das Recht vor, das Design der Rosetten und die Länge der Kabel ohne Vorankündigung zu ändern.

Die Dimmbarkeit der Pendel- und Wandleuchten mit den E27-Fassungen (E26) und E14-Fassungen (E12) ist von der Dimmbarkeit der gewählten Lichtquelle abhängig.

Die Farben der Produkte können sich von den Abbildungen im Katalog unterscheiden und von einem Fertigungslos zum anderen variieren.

Die angegebenen Lumen sind Nominalwerte.

Der zuständige Gerichtshof ist Mailand (Italien).

<sup>ES</sup> La mercancía se entiende a portes debidos.

La mercancía está atentamente y cuidadosamente embalada, Kdln srl declina cualquier responsabilidad por los daños causados por el transporte.

Todas las mercancías viajan a riesgo del comerciante aunque se hayan franqueado por el destinatario.

Las reclamaciones por defectos aparentes y ocultos tienen que ser comunicados por mail o por fax dentro de 8 días del recibo de la mercancías.

Kdln se reserva el derecho de modificar cualquiera de las cláusulas precedentes sin aviso previo en caso de necesidades, decisiones o exigencias propias.

Las lámparas de suspensión cuentan con cables de 180 cm (70.9 in).

Bajo petición, se pueden producir diversas medidas.

De todas formas, la sociedad se reserva el derecho de cambiar el diseño de los florones y la longitud de los cables sin previo aviso.

La dimabilidad de las lámparas a suspensión y de las lámparas a pared con enchufe E27 (E26) y E14 (E12) depende de la dimabilidad de la fuente de luz elegida.

Los lúmenes indicados son nominales.

Los colores de los productos pueden variar respecto a lo que se muestra en el catálogo y de un lote a otro. Para toda pendencia el Forum implicado es Milán (Italia).

## MARKING



Class I luminaire: it's necessary to connect the device to the yellow/green protective conductor (earthing).

Apparecchio in Classe I: è obbligatoria la connessione al conduttore di protezione giallo/verde (messa a terra).

Classe I: il est obligatoire de relier l'appareil à la terre.

Schutzklasse I: alle berührbaren Metallteile sind elektrisch leitend miteinander verbunden und werden mit dem Netzschutzleiter verbunden.

Aparato en clase I: es obligatoria la conexión al conductor de protección amarillo/verde (toma de tierra).



Class II luminaire: appliance with double insulation.

Apparecchio in Classe II: apparecchio in doppio isolamento.

Classe II: appareil dote de double isolation.

Schutzklasse II: gerat mit doppelter isolierung.

Aparato en clase II: aparato provisto de aislamiento doble.



Class III luminaire: appliance in which protection against electrical shock is guaranteed by the extremely lowvoltage power supply.

Apparecchio in Classe III: apparecchio in cui la protezione contro la scossa elettrica si basa sulla alimentazione a bassissima tensione di sicurezza.

Classe III: appareil avec protection contre les décharges électriques basée sur l'alimentation à une tension de sécurité très basse.

Schutzklasse III: Zum Schutz vor elektrischen Schlägen mit Niedervolt gespeistes Gerät.

Aparato en clase III: aparato en el cual la protección contra la descarga eléctrica se debe a la alimentación a muy baja tensión.

## IP20

Device protected against the penetration of solid objects greater than 12mm.

Apparecchio protetto contro la penetrazione di corpi solidi di dimensioni maggiori a 12mm.

Protégé contre la pénétration des corps solides aux dimensions supérieures à 12mm.

Gegen das Eindringen von Festkörpern größer als 12mm geschützt.

Protección contra la penetración de cuerpos sólidos de un tamaño superior a 12mm.

## IP65

Device dust-tight and protected against water jets.

Apparecchio totalmente protetto contro la polvere e protetto contro i getti d'acqua.

Appareil totalement protégé contre la poussière et les projections d'eau.

Gerät mit absolutem Schutz gegen das Eindringen von Staub und geschützt gegen Druckwasser.

Aparato totalmente protegido contra el polvo y los chorros de agua.

## CE

It certifies the conformity of the product to the European community directives.

Attesta la conformità del prodotto alle disposizioni della Comunità Europea.

Il atteste la conformité du produit aux directives de la Communauté Européenne.

Das Zeichen bescheinigt die Konformität des Produktes mit den Bestimmungen der Europäischen Gemeinschaft.

Certifica la conformidad del producto con las disposiciones de la Comunidad Europea.

## EAC

It certifies the conformity of the product to the Eurasian Customs Union directives.

Attesta la conformità del prodotto alle disposizioni dell'Unione doganale eurasiatica.

Il atteste la conformità du produit aux directives de l'union douanière eurasiatique.

Das Zeichen bescheinigt die Konformität des Produktes mit den Bestimmungen der Eurasischen Zollunion.

Certifica la conformidad del producto con las disposiciones de la Unión Aduanera Euroasiática.



It certifies the conformity of the product to the North American market directives.

Attesta la conformità del prodotto alle disposizioni del mercato nordamericano.

Il atteste la conformité du produit aux directives du marché nord-américain.

Das Zeichen bescheinigt, dass das Produkt den Vorschriften des nordamerikanischen Marktes entspricht.

Certifica la conformidad del producto con las disposiciones del mercado norteamericano. Marca de conformidad U.S.A. y Canada.

# COLLECTION

## **FLOOR**

p. 14

## **TABLE**

p. 27

## **SUSPENSION**

p. 38

## **WALL**

p. 91

# EVITA

AQUILIALBERG, 2011



CODE	COLOUR	PRICE VAT excl.
K155060B / GB	warm white	<b>1490 €</b>
K155060N / GB	black	
K155060T / GB	dove-grey	
K155060R / GB	red	

## LIGHT SOURCE\*

2x54W - T5 fluorescent  
or compatible LED light source

## FEEDING

220-240 / 120 V

## DIMMER

yes

## LIGHT DIRECTION



## CERTIFICATIONS

⊕ IP20 CE ENEC

## MATERIALS

steel + technopolymers

## PACKAGING

### BOX 1

gross w. 12.54 kg / 27.59 lbs  
vol. 0.219 m<sup>3</sup> / 4.548 ft<sup>3</sup>  
dim. L 25.5 x W 25 x H 202 cm  
L 10 x W 9.8 x H 79.5 in

### BOX 2

gross w. 6.32 kg / 13.9 lbs  
vol. 0.006 m<sup>3</sup> / 0.203 ft<sup>3</sup>  
dim. L 41 x W 40 x H 3.5 cm  
L 16.1 x W 15.7 x H 1.4 in

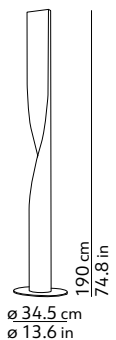

# E.T.A.

GUGLIELMO BERCHICCI, 1996



CODE	COLOUR	PRICE VAT excl.
0171596BIEU / GB	white	<b>1230 €</b>
0171596AREU / GB	orange	

**LIGHT SOURCE\***

3x40W max - E14 (E12) +  
1x100W max - E27 (E26)

**FEEDING**

220-240 / 120 V

**DIMMER**

yes

**LIGHT DIRECTION**



**CERTIFICATIONS**

☐ IP20 CE ENEC

**MATERIALS**

fiberglass + metal

**PACKAGING**

**BOX 1**

gross w. 14.32 kg / 31.50 lbs  
vol. 0.399 m<sup>3</sup> / 14.089 ft<sup>3</sup>  
dim. L 44 x W 45 x H 201.5 cm  
L 17.3 x W 17.7 x H 79.3 in



white



orange

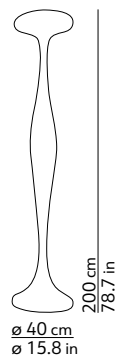



# FLOOR

KARIM RASHID, 2005



CODE	COLOUR	PRICE VAT excl.
018873TREU / GB	transparent	<b>670 €</b>

**LIGHT SOURCE\***

1x100W max - E27 (E26)

**FEEDING**

220-240 / 120 V

**DIMMER**

no

**LIGHT DIRECTION**



**CERTIFICATIONS**

☐ IP20 CE ENEC

**MATERIALS**

plexiglas + aluminium

**PACKAGING**

**BOX 1**

gross w. 11.4 kg / 25.08 lbs  
 vol. 0.512 m<sup>3</sup> / 18.077 ft<sup>3</sup>  
 dim. L 50 x W 52.5 x H 195 cm  
 L 19.7 x W 20.7 x H 76.7 in



transparent

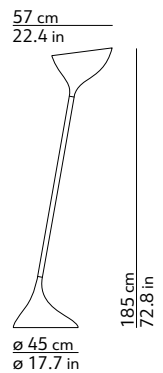

# KUSHI FLOOR

ALBERTO SAGGIA & VALERIO SOMMELLA, 2016



CODE	COLOUR	PRICE VAT excl.
K2281059N / GB	black	<b>960 €</b>
K2281059O / GB	brass	
K2281059R / GB	copper	

## LIGHT SOURCE\*

board LED 3x4.6W  
 2700 K - 1900 lm - CRI>80

## FEEDING

100-240 V

## DIMMER

yes

## LIGHT DIRECTION



## CERTIFICATIONS

☐ IP20 CE ENEC

## MATERIALS

glass + metal

## PACKAGING

### BOX 1

gross w. 7.4 kg / 16.28 lbs  
 vol. 0.179 m<sup>3</sup> / 6.317 ft<sup>3</sup>  
 dim. L 138 x W 42.5 x H 30.5 cm  
 L 54.3 x W 16.7 x H 12 in



black RAL9005



brass 205



copper 212

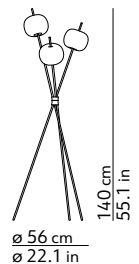

# KUSHI XL FLOOR

ALBERTO SAGGIA & VALERIO SOMMELLA, 2019



CODE	COLOUR	PRICE VAT excl.
K219105N / GB	black	<b>1100 €</b>
K219105O / GB	brass	
K219105R / GB	copper	

## LIGHT SOURCE\*

2x70W max - E27 (E26)  
 Ø 6cm max

## FEEDING

220-240 / 120 V

## DIMMER

yes

## LIGHT DIRECTION



## CERTIFICATIONS

IP20 CE ENEC

## MATERIALS

glass + metal

## PACKAGING

### BOX 1

gross w. 4.75 kg / 10.45 lbs  
 vol. 0.103 m<sup>3</sup> / 3.647 ft<sup>3</sup>  
 dim. L 50.5 x W 50.5 x H 40.2 cm  
 L 19.9 x W 19.5 x H 15.9 in

### BOX 2

gross w. 3.24 kg / 7.13 lbs  
 vol. 0.057 m<sup>3</sup> / 2.031 ft<sup>3</sup>  
 dim. L 168 x W 18.5 x H 18.5 cm  
 L 66.1 x W 7.3 x H 7.3 in

### BOX 3

gross w. 11.12 kg / 24.46 lbs  
 vol. 0.012 m<sup>3</sup> / 0.407 ft<sup>3</sup>  
 dim. L 48 x W 48 x H 5 cm  
 L 18.9 x W 18.9 x H 2 in

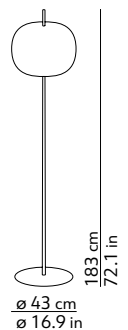

# KYUDO

HANSANDFRANZ, 2010



CODE	COLOUR	PRICE VAT excl.
K048133BIEU / GB	white	<b>1560 €</b>
K048133NEEU / GB	black	
K048133AREU / GB	orange	

**LIGHT SOURCE\***

strip LED 1x43.2W  
2700 K - 4200 lm - CRI>90

**FEEDING**

100-240 V

**DIMMER**

yes

**LIGHT DIRECTION**



**CERTIFICATIONS**

IP20 CE ENEC

**MATERIALS**

aluminium

**PACKAGING**

**BOX 1**

gross w. 6.92 kg / 15.22 lbs  
vol. 0.080 m<sup>3</sup> / 2.831 ft<sup>3</sup>  
dim. L 46 x W 10.5 x H 166 cm  
L 18.1 x W 4.1 x H 65.4 in

**BOX 2**

gross w. 7.52 kg / 16.54 lbs  
vol. 0.021 m<sup>3</sup> / 0.735 ft<sup>3</sup>  
dim. L 51 x W 51 x H 8 cm  
L 20.1 x W 20.1 x H 3.2 in

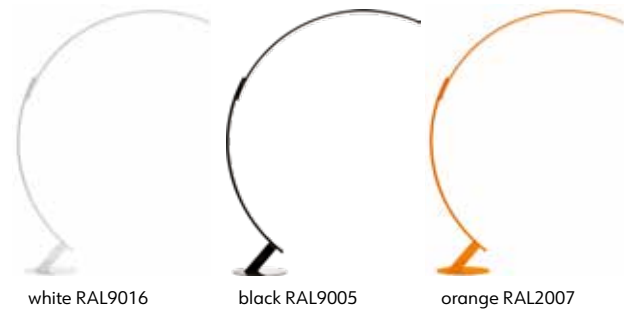

white RAL9016

black RAL9005

orange RAL2007

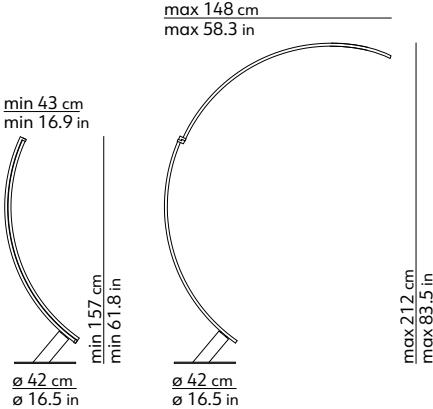

# OPYO FLOOR

CRISTINA CELESTINO, 2019



CODE	COLOUR	PRICE VAT excl.
K350355B / GB	white	<b>896 €</b>
K350355C / GB	coral	
K350355O / GB	brass	

**LIGHT SOURCE\***

1x70W max - E27 (E26)

**FEEDING**

220-240 / 120 V

**DIMMER**

yes

**LIGHT DIRECTION**



**CERTIFICATIONS**

☐ IP20 CE ENEC

**MATERIALS**

glass + metal

**PACKAGING**

**BOX 1**

gross w. 2.00 kg / 4.40 lbs  
 vol. 0.027 m<sup>3</sup> / 0.968 ft<sup>3</sup>  
 dim. L 29.5 x W 29.5 x H 31.5 cm  
 L 11.6 x W 11.6 x H 12.4 in

**BOX 2**

gross w. 3.50 kg / 7.70 lbs  
 vol. 0.046 m<sup>3</sup> / 1.625 ft<sup>3</sup>  
 dim. L 165 x W 18.5 x H 15 cm  
 L 65 x W 7.3 x H 5.9 in

**BOX 3**

gross w. 12.00 kg / 26.40 lbs  
 vol. 0.007 m<sup>3</sup> / 0.249 ft<sup>3</sup>  
 dim. L 17.5 x W 17.5 x H 23 cm  
 L 6.9 x W 6.9 x H 9.1 in

**BOX 4**

gross w. 1.54 kg / 3.39 lbs  
 vol. 0.012 m<sup>3</sup> / 0.410 ft<sup>3</sup>  
 dim. L 22 x W 22 x H 24 cm  
 L 8.7 x W 8.7 x H 9.5 in



white RAL9010

coral RAL3012

brass 219

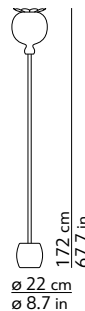

# POISE FLOOR

ROBERT DABI, 2022

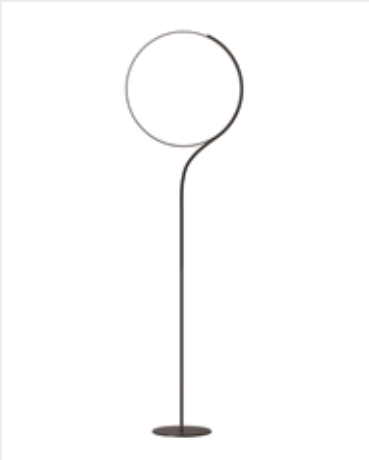

CODE	COLOUR	PRICE VAT excl.
505425N / GB	black	550 €

### LIGHT SOURCE\*

strip LED 1x28W  
2700 K - 3600 lm - CRI>90

### FEEDING

220-240 / 120 V

### DIMMER

yes

### LIGHT DIRECTION



### CERTIFICATIONS

☐ IP20 CE ENEC

### MATERIALS

metal

### PACKAGING

#### BOX 1

gross w. 7.7 kg / 16.8 lbs  
vol. 0.028 m<sup>3</sup> / 0.989 ft<sup>3</sup>  
dim. L 63 x W 63 x H 7 cm  
L 24.8 x W 24.8 x H 2.8 in



black RAL9005

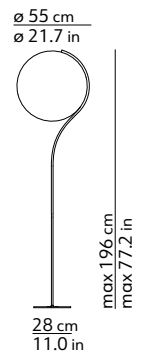

# SHAKTI

MARZIO RUSCONI CLERICI, 2001



CODE	COLOUR	PRICE VAT excl.
<b>SHAKTI 200</b>		
KSA110BIEU / GB	white + satin base	<b>720 €</b>
KCR110BIEU / GB	white + polished base	<b>760 €</b>
<b>SHAKTI 250</b>		
KSA111BIEU / GB	white + satin base	<b>890 €</b>

## LIGHT SOURCE\*

2x100W max - E27 (E26)

## FEEDING

220-240 / 120 V

## DIMMER

yes

## LIGHT DIRECTION



## CERTIFICATIONS

IP20 CE ENEC

## MATERIALS

plexiglas + steel

## PACKAGING

### SHAKTI 200

#### BOX 1

gross w. 5.50 kg / 12.10 lbs  
vol. 0.116 m<sup>3</sup> / 4.110 ft<sup>3</sup>  
dim. L 220 x W 23 x H 23 cm  
L 86.6 x W 9.1 x H 9.1 in

#### BOX 2

gross w. 3.46 kg / 7.61 lbs  
vol. 0.007 m<sup>3</sup> / 0.230 ft<sup>3</sup>  
dim. L 37 x W 32 x H 5.5 cm  
L 14.6 x W 12.6 x H 2.2 in

### SHAKTI 250

#### BOX 1

gross w. 6.88 kg / 15.14 lbs  
vol. 0.174 m<sup>3</sup> / 6.129 ft<sup>3</sup>  
dim. L 267 x W 26 x H 25 cm  
L 105.1 x W 10.2 x H 9.8 in

#### BOX 2

gross w. 4.84 kg / 10.65 lbs  
vol. 0.008 m<sup>3</sup> / 0.287 ft<sup>3</sup>  
dim. L 36.5 x W 40.5 x H 5.5 cm  
L 14.4 x W 15.9 x H 2.2 in



white

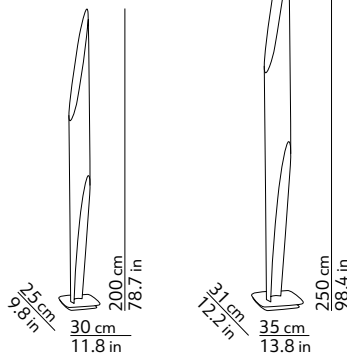

# SPILO FLOOR

CONSTANTIN WORTMANN, 2010



CODE	COLOUR	PRICE VAT excl.
232134EU / GB	white	<b>659 €</b>

#### LIGHT SOURCE\*

1x21W max - E27 (E26)  
 Ø 5cm max

#### FEEDING

220-240 / 120 V

#### DIMMER

no

#### LIGHT DIRECTION



#### CERTIFICATIONS

☐ IP20 CE ENEC

#### MATERIALS

polyethylene + metal

#### PACKAGING

##### BOX 1

gross w. 8.94 kg / 19.67 lbs  
 vol. 0.218 m<sup>3</sup> / 7.688 ft<sup>3</sup>  
 dim. L 129.5 x W 41 x H 41 cm  
 L 51 x W 16.1 x H 16.1 in



white

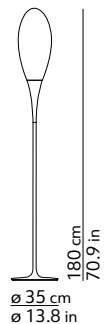



# SPILLO OUTDOOR

CONSTANTIN WORTMANN, 2010



CODE	COLOUR	PRICE VAT excl.
<b>SPILLO OUTDOOR FIX</b> K232134IPEU	white	<b>550 €</b>
<b>SPILLO OUTDOOR FLOOR</b> K232134EU	white	<b>778 €</b>
<b>SPILLO OUTDOOR PEG</b> 232134IPEU	white	<b>583 €</b>

**LIGHT SOURCE\***

1x21W max - E27 (E26)  
Ø 5cm max

**FEEDING**

220-240 / 120 V

**DIMMER**

no

**LIGHT DIRECTION**



**CERTIFICATIONS**

☐ IP65 CE ENEC

**MATERIALS**

polyethylene + metal

**PLUG**

IP65 connector

**PACKAGING**

**SPILLO OUTDOOR FIX**  
**SPILLO OUTDOOR FLOOR**  
**SPILLO OUTDOOR PEG**

**BOX 1**

gross w. 2.92 kg / 6.42 lbs  
vol. 0.047 m<sup>3</sup> / 1.647 ft<sup>3</sup>  
dim. L 26 x W 26 x H 69 cm  
L 10.2 x W 10.2 x H 27.2 in

**SPILLO OUTDOOR FIX**

**BOX 2**

gross w. 1.54 kg / 3.39 lbs  
vol. 0.028 m<sup>3</sup> / 0.988 ft<sup>3</sup>  
dim. L 56 x W 37 x H 13.5 cm  
L 22.1 x W 14.6 x H 5.3 in

**SPILLO OUTDOOR FLOOR**

**BOX 2**

gross w. 5.96 kg / 13.11 lbs  
vol. 0.028 m<sup>3</sup> / 0.988 ft<sup>3</sup>  
dim. L 56 x W 37 x H 13.5 cm  
L 22.1 x W 14.6 x H 5.3 in

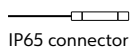

IP65 connector

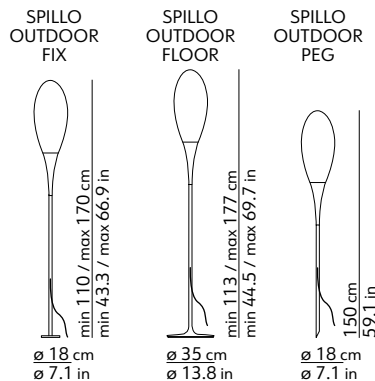

# TRIPOD FLOOR

CHRISTOPHE PILLET, 2002



CODE	COLOUR	PRICE VAT excl.
K947BIEU / GB	white	<b>815 €</b>
K947BEEU / GB	ecrù	
K947MOEU / GB	moka	

## LIGHT SOURCE\*

3x70W max - E27 (E26)

## FEEDING

220-240 / 120 V

## DIMMER

yes

## LIGHT DIRECTION



## CERTIFICATIONS

☐ IP20 CE ENEC

## MATERIALS

metal + fabric

## PACKAGING

### BOX 1

gross w. 3.54 kg / 7.79 lbs  
 vol. 0.119 m<sup>3</sup> / 4.195 ft<sup>3</sup>  
 dim. L 60 x W 60 x H 33 cm  
 L 23.6 x W 23.6 x H 13 in

### BOX 2

gross w. 4.4 kg / 9.68 lbs  
 vol. 0.060 m<sup>3</sup> / 2.133 ft<sup>3</sup>  
 dim. L 176.5 x W 18.5 x H 18.5 cm  
 L 69.5 x W 7.3 x H 7.3 in



white



ecrù



moka

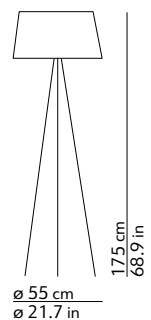

# TYLA

MARC SADLER, 2021



CODE	COLOUR	PRICE VAT excl.
K501418B / GB	white	<b>935 €</b>
K501418BLU / GB	dark blue	
K501418RO / GB	red	

## LIGHT SOURCE\*

1x70W max - E27 (E26)

## FEEDING

220-240 / 120 V

## DIMMER

yes

## LIGHT DIRECTION



## CERTIFICATIONS

IP20 CE ENEC

## MATERIALS

glass + steel

## PACKAGING

### BOX 1

gross w. 7 kg / 15.43 lbs  
 vol. 0.109 m<sup>3</sup> / 3.858 ft<sup>3</sup>  
 dim. L 51 x W 51 x H 42 cm  
 L 20.1 x W 20.1 x H 16.5 in

### BOX 2

gross w. 10 kg / 22.05 lbs  
 vol. 0.062 m<sup>3</sup> / 2.176 ft<sup>3</sup>  
 dim. L 180 x W 18.5 x H 18.5 cm  
 L 70.9 x W 7.3 x H 7.3 in

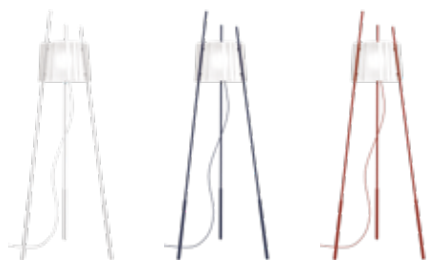

white RAL9010

dark blue RAL5004

red RAL3004

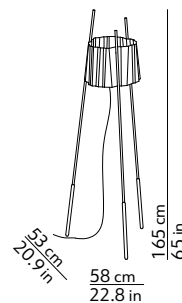

# ATOMIUM

HOPF&WORTMANN - BÜRO FÜR FORM, 2006



CODE	COLOUR	PRICE VAT excl.
011890BIEU / GB	white	535 €

**LIGHT SOURCE\***

6x40W max - E14 (E12)

**FEEDING**

220-240 / 120 V

**DIMMER**

no

**LIGHT DIRECTION**



**CERTIFICATIONS**

☐ IP20 CE ENEC

**MATERIALS**

polyethylene

**PACKAGING**

**BOX 1**

gross w. 7.92 kg / 17.42 lbs  
 vol. 0.199 m<sup>3</sup> / 7.042 ft<sup>3</sup>  
 dim. L 65 x W 59 x H 52 cm  
 L 25.6 x W 23.2 x H 20.5 in



white

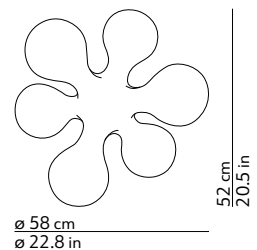

# HIVE

INI ARCHIBONG, 2017



CODE	COLOUR	PRICE VAT excl.
K390325B / GB	white	<b>520 €</b>
K390325N / GB	black	
K390325R / GB	red	

## LIGHT SOURCE\*

1x30W max - E27 (E26)

## FEEDING

220-240 / 120 V

## DIMMER

no

## LIGHT DIRECTION



## CERTIFICATIONS

IP20 CE ENEC

## MATERIALS

glass + ceramic

## PACKAGING

### BOX 1

gross w. 2.2 kg / 4.84 lbs  
 vol. 0.033 m<sup>3</sup> / 1.157 ft<sup>3</sup>  
 dim. L 32 x W 32 x H 32 cm  
 L 12.6 x W 12.6 x H 12.6 in

### BOX 2

gross w. 2.72 kg / 5.98 lbs  
 vol. 0.033 m<sup>3</sup> / 1.157 ft<sup>3</sup>  
 dim. L 32 x W 32 x H 32 cm  
 L 12.6 x W 12.6 x H 12.6 in



white



black



red

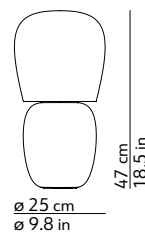

# KUSHI 16 MOBILE

ALBERTO SAGGIA & VALERIO SOMMELLA, 2017



CODE	COLOUR	PRICE VAT excl.
K2291059N	black	<b>280 €</b>
K2291059O	brass	
K2291059R	copper	

## LIGHT SOURCE\*

board LED 1x1.3W  
 2700 K - 150 lm - CRI>80

## FEEDING\*\*

rechargeable battery  
 5 V min 500 mA

## DIMMER

no

## LIGHT DIRECTION



## CERTIFICATIONS

◆ IP20 CE ENEC

## MATERIALS

glass + metal

## BATTERY LIFE

5h 30min

## PACKAGING

### BOX 1

gross w. 0.86 kg / 1.89 lbs  
 vol. 0.011 m<sup>3</sup> / 0.380 ft<sup>3</sup>  
 dim. L 23.5 x W 23.5 x H 19.5 cm  
 L 9.3 x W 9.3 x H 7.7 in

### BOX 2

gross w. 0.42 kg / 0.92 lbs  
 vol. 0.005 m<sup>3</sup> / 0.159 ft<sup>3</sup>  
 dim. L 14 x W 14 x H 23 cm  
 L 5.5 x W 5.5 x H 9.1 in



black RAL9005



brass 205



copper 212

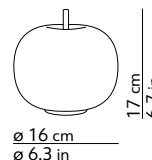

# KUSHI 16 TABLE

ALBERTO SAGGIA & VALERIO SOMMELLA, 2015



CODE	COLOUR	PRICE VAT excl.
K227105N / GB	black	<b>248 €</b>
K227105O / GB	brass	
K227105R / GB	copper	

## LIGHT SOURCE\*

1x25W max - G9

## FEEDING

220-240 / 120 V

## DIMMER

no

## LIGHT DIRECTION



## CERTIFICATIONS

☐ IP20 CE ENEC

## MATERIALS

glass + metal

## PACKAGING

### BOX 1

gross w. 0.86 kg / 1.89 lbs  
 vol. 0.011 m<sup>3</sup> / 0.380 ft<sup>3</sup>  
 dim. L 23.5 x W 23.5 x H 19.5 cm  
 L 9.3 x W 9.3 x H 7.7 in

### BOX 2

gross w. 0.42 kg / 0.92 lbs  
 vol. 0.005 m<sup>3</sup> / 0.159 ft<sup>3</sup>  
 dim. L 14 x W 14 x H 23 cm  
 L 5.5 x W 5.5 x H 9.1 in



black RAL9005



brass 205



copper 212

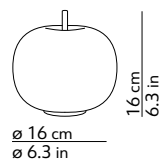

# KUSHI 33 TABLE

ALBERTO SAGGIA & VALERIO SOMMELLA, 2015



CODE	COLOUR	PRICE VAT excl.
K222105N / GB	black	<b>430 €</b>
K222105O / GB	brass	
K222105R / GB	copper	

## LIGHT SOURCE\*

1x30W max - E27 (E26)

## FEEDING

220-240 / 120 V

## DIMMER

yes

## LIGHT DIRECTION



## CERTIFICATIONS

IP20 CE ENEC

## MATERIALS

glass + metal

## PACKAGING

### BOX 1

gross w. 3.34 kg / 7.35 lbs  
 vol. 0.055 m<sup>3</sup> / 1.949 ft<sup>3</sup>  
 dim. L 40 x W 40 x H 34.5 cm  
 L 15.8 x W 15.8 x H 13.6 in

### BOX 2

gross w. 0.92 kg / 2.02 lbs  
 vol. 0.012 m<sup>3</sup> / 0.411 ft<sup>3</sup>  
 dim. L 18.5 x W 18.5 x H 34 cm  
 L 7.3 x W 7.3 x H 13.4 in



black RAL9005

brass 205

copper 212

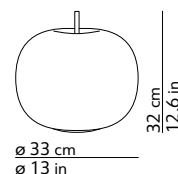



# KUSHI XL TABLE

ALBERTO SAGGIA & VALERIO SOMMELLA, 2019



CODE	COLOUR	PRICE VAT excl.
K223105N / GB	black	<b>545 €</b>
K223105O / GB	brass	
K223105R / GB	copper	

## LIGHT SOURCE\*

1x70W max - E27 (E26)

## FEEDING

220-240 / 120 V

## DIMMER

yes

## LIGHT DIRECTION



## CERTIFICATIONS

IP20 CE ENEC

## MATERIALS

glass + metal

## PACKAGING

### BOX 1

gross w. 3.34 kg / 7.35 lbs  
 vol. 0.055 m<sup>3</sup> / 1.949 ft<sup>3</sup>  
 dim. L 40 x W 40 x H 34.5 cm  
 L 15.8 x W 15.8 x H 13.6 in

### BOX 2

gross w. 3.93 kg / 8.65 lbs  
 vol. 0.016 m<sup>3</sup> / 0.552 ft<sup>3</sup>  
 dim. L 25 x W 25 x H 55 cm  
 L 9.8 x W 9.8 x H 21.7 in



black RAL9005

brass 205

copper 304

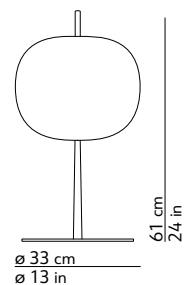

# LANNÀ TABLE

NOÉ DUCHAUFURLAWRANCE, 2017



CODE	COLOUR	PRICE VAT excl.
K385320N / GB	black	<b>465 €</b>
K385320 / GB	brass	

**LIGHT SOURCE\***

1x20W max - E27 (E26)  
 Ø 6cm max

**FEEDING**

220-240 / 120 V

**DIMMER**

no

**LIGHT DIRECTION**



**CERTIFICATIONS**

☐ IP20 CE ENE

**MATERIALS**

glass + metal

**PACKAGING**

**BOX 1**

gross w. 2.02 kg / 4.44 lbs  
 vol. 0.022 m<sup>3</sup> / 0.788 ft<sup>3</sup>  
 dim. L 26 x W 26 x H 33 cm  
 L 10.2 x W 10.2 x H 13 in

**BOX 2**

gross w. 1.96 kg / 4.31 lbs  
 vol. 0.026 m<sup>3</sup> / 0.927 ft<sup>3</sup>  
 dim. L 44.5 x W 29.5 x H 20 cm  
 L 17.5 x W 11.6 x H 7.9 in



black RAL9005



brass 209

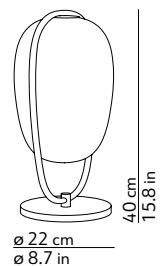

# POISE

ROBERT DABI, 2021



CODE	COLOUR	PRICE VAT excl.
505424N / GB	black	<b>340 €</b>

**LIGHT SOURCE\***

strip LED 1x13.5W  
2700 K - 1050 lm - CRI>90

**FEEDING**

220-240 / 120 V

**DIMMER**

yes

**LIGHT DIRECTION**



**CERTIFICATIONS**

☐ IP20 CE ENEC

**MATERIALS**

metal

**PACKAGING**

**BOX 1**

gross w. 3.7 kg / 8.2 lbs  
vol. 0.056 m<sup>3</sup> / 1.978 ft<sup>3</sup>  
dim. L 69 x W 54 x H 15 cm  
L 27.2 x W 21.3 x H 5.9 in



black RAL9005

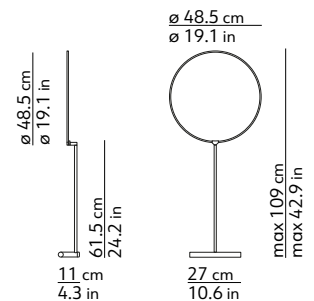

# TATU

MR SMITH STUDIO, 2019



CODE	COLOUR	PRICE VAT excl.
K360375N / GB	black	<b>724 €</b>
K360375O / GB	brass	

**LIGHT SOURCE\***  
1x100W max - E27 (E26)

**FEEDING**  
220-240 / 120 V

**DIMMER**  
yes

**LIGHT DIRECTION**



**CERTIFICATIONS**  
IP20 CE ENEC

**MATERIALS**  
glass + metal

**PACKAGING**  
**BOX 1**  
gross w. 2.5 kg / 5.5 lbs  
vol. 0.064 m³ / 2.260 ft³  
dim. L 40 x W 40 x H 40 cm  
L 15.8 x W 15.8 x H 15.8 in

**BOX 2**  
gross w. 4 kg / 8.8 lbs  
vol. 0.128 m³ / 4.520 ft³  
dim. L 35 x W 35 x H 73 cm  
L 13.8 x W 13.8 x H 31.5 in



black RAL9005      brass 219

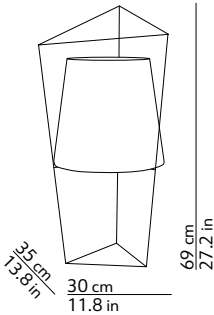

# TOOT TABLE

KARIM RASHID, 2017



CODE	COLOUR	PRICE VAT excl.
K400335 / GB	mixed colours	1330 €

## LIGHT SOURCE\*

board LED 3x5W  
2700 K - 1500 lm - CRI>90

## FEEDING

100-240 V

## DIMMER

yes

## LIGHT DIRECTION



## CERTIFICATIONS

☐ IP20 CE ENEC

## MATERIALS

plexiglas + metal

## PACKAGING

### BOX 1

gross w. 3.2 kg / 7.04 lbs  
vol. 0.033 m<sup>3</sup> / 1.171 ft<sup>3</sup>  
dim. L 27 x W 27 x H 45.5 cm  
L 10.7 x W 10.7 x H 17.9 in

### BOX 2

gross w. 3.82 kg / 8.40 lbs  
vol. 0.033 m<sup>3</sup> / 1.171 ft<sup>3</sup>  
dim. L 27 x W 27 x H 45.5 cm  
L 10.7 x W 10.7 x H 17.9 in



mixed colours

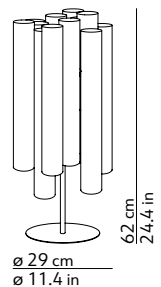

# TRIPOD TABLE

CHRISTOPHE PILLET, 2002



CODE	COLOUR	PRICE VAT excl.
K946BIEU / GB	white	<b>480 €</b>
K946BEEU / GB	ecrù	
K946MOEU / GB	moka	

**LIGHT SOURCE\***

3x40W max - E14 (E12)

**FEEDING**

220-240 / 120 V

**DIMMER**

no

**LIGHT DIRECTION**



**CERTIFICATIONS**

IP20 CE ENEC

**MATERIALS**

metal + fabric

**PACKAGING**

**BOX 1**

gross w. 1.38 kg / 3.04 lbs  
 vol. 0.032 m<sup>3</sup> / 1.128 ft<sup>3</sup>  
 dim. L 39 x W 39 x H 21 cm  
 L 15.4 x W 15.4 x H 8.3 in

**BOX 2**

gross w. 1.86 kg / 4.09 lbs  
 vol. 0.024 m<sup>3</sup> / 0.851 ft<sup>3</sup>  
 dim. L 24 x W 20.5 x H 49 cm  
 L 9.5 x W 8.1 x H 19.3 in



white

ecrù

moka

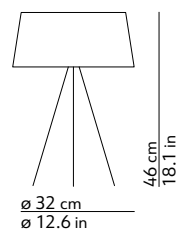

# LINEAR CANOPY 80

CODE	COLOUR	PRICE VAT excl.
500507B 500507MI	white mirrored	<b>490 €</b>

## FEEDING

220-240 V

## CERTIFICATIONS

⊕ IP20 CE ENEC

## MATERIALS

### INTERNAL CANOPY

metal - white RAL9010

### CANOPY COVER

metal - mirrored or white RAL9010

## PACKAGING

### BOX 1

gross w. 4 kg / 8.82 lbs

vol. 0.020 m<sup>3</sup> / 0.706 ft<sup>3</sup>

dim. L 100 x W 20 x H 10 cm

L 39.4 x W 7.9 x H 3.9 in

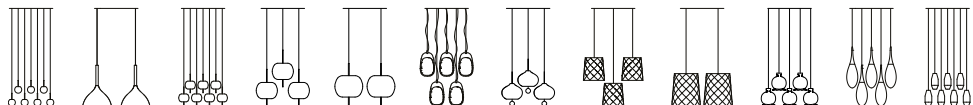
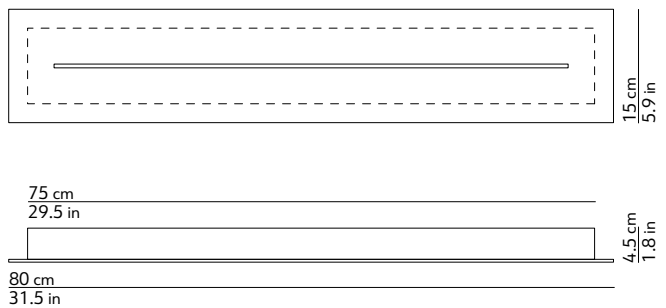

COMPATIBLE LAMP	N. LAMPS	CODE	COLOUR	PRICE VAT excl. *
DEW	from 2 to 7 max	0451371CREU	chrome	310 €
		0451371NEU	black	339 €
		0451371OEU	brass	
FLOOB CEILING	2 max	0181634TREU	transparent	490 €
KUSHI 16 SUSPENSION	from 2 to 7 max	K226105N	black	270 €
		K226105O	brass	
		K226105R	copper	
KUSHI 33 SUSPENSION	from 2 to 3 max	K221105N	black	446 €
		K221105O	brass	
		K221105R	copper	
KUSHI XL SUSPENSION	2 max	K218105N	black	643 €
		K218105O	brass	
		K218105R	copper	
LANNÀ SUSPENSION	from 2 to 5 max	K386320N	black	440 €
		K386320	brass	
LILLI	from 2 to 3 max	K355365O	brass	621 €
NEW YORK 33	from 2 to 3 max	K090261MB	white	362 €
		K090261MC	grey chrome	
		K090261MR	red	
NEW YORK 45	2 max	K090261LB	white	513 €
		K090261LC	grey chrome	
		K090261LR	red	
OPYO SUSPENSION	from 2 to 5 max	K350356B	white	358 €
		K350356C	coral	
		K350356O	brass	
SPIILLO CEILING	from 2 to 5 max	232135EU	white	356 €
YUMA	from 2 to 7 max	370310EU	brass	310 €

\* price for 1 lamp



# LINEAR CANOPY 140

CODE	COLOUR	PRICE VAT excl.
500508B 500508MI	white mirrored	<b>680 €</b>

## FEEDING

220-240 V

## CERTIFICATIONS

⊕ IP20 CE ENEC

## MATERIALS

### INTERNAL CANOPY

metal - white RAL9010

### CANOPY COVER

metal - mirrored or white RAL9010

## PACKAGING

### BOX 1

gross w. 7 kg / 15.43 lbs

vol. 0.032 m<sup>3</sup> / 1.130 ft<sup>3</sup>

dim. L 160 x W 20 x H 10 cm

L 63 x W 7.9 x H 3.9 in

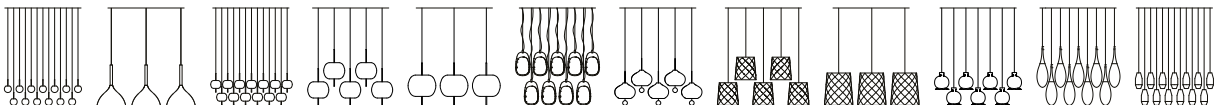
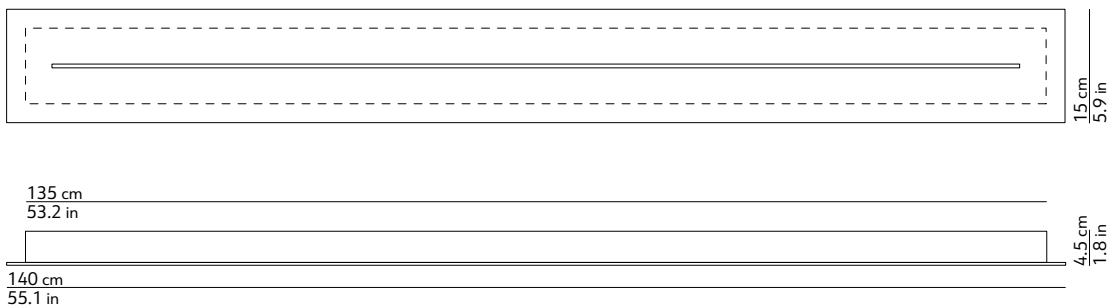

COMPATIBLE LAMP	N. LAMPS	CODE	COLOUR	PRICE VAT excl. *
DEW	from 2 to 13 max	0451371CREU	chrome	310 €
		0451371NEU	black	339 €
		0451371OEU	brass	
FLOOB CEILING	from 2 to 3 max	0181634TREU	transparent	490 €
KUSHI 16 SUSPENSION	from 2 to 13 max	K226105N	black	270 €
		K226105O	brass	
		K226105R	copper	
KUSHI 33 SUSPENSION	from 2 to 5 max	K221105N	black	446 €
		K221105O	brass	
		K221105R	copper	
KUSHI XL SUSPENSION	from 2 to 3 max	K218105N	black	643 €
		K218105O	brass	
		K218105R	copper	
LANNÀ SUSPENSION	from 2 to 9 max	K386320N K386320	black brass	440 €
LILLI	from 2 to 5 max	K355365O	brass	621 €
NEW YORK 33	from 2 to 5 max	K090261MB	white	362 €
		K090261MC	grey chrome	
		K090261MR	red	
NEW YORK 45	from 2 to 3 max	K090261LB	white	513 €
		K090261LC	grey chrome	
		K090261LR	red	
OPYO SUSPENSION	from 2 to 8 max	K350356B	white	358 €
		K350356C	coral	
		K350356O	brass	
SPIILLO CEILING	from 2 to 9 max	232135EU	white	356 €
YUMA	from 2 to 13 max	370310EU	brass	310 €

\* price for 1 lamp

## ROUND CANOPY 66

CODE	COLOUR	PRICE VAT excl.
<b>ROUND CANOPY 6</b>		
500512B	white	595 €
500512MI	mirrored	640 €
<b>ROUND CANOPY 8</b>		
500513B	white	630 €
500513MI	mirrored	680 €
<b>ROUND CANOPY 12</b>		
500514B	white	670 €
500514MI	mirrored	720 €

### FEEDING

220-240 V

### CERTIFICATIONS

⊕ IP20 CE ENEC

### MATERIALS

#### INTERNAL CANOPY

metal - white RAL9010

#### CANOPY COVER

metal - mirrored or white RAL9010

### PACKAGING

#### BOX 1

gross w. 6 kg / 13.23 lbs

vol. 0.072 m<sup>3</sup> / 2.551 ft<sup>3</sup>

dim. L 85 x W 85 x H 10 cm

L 33.5 x W 33.5 x H 3.9 in

ROUND CANOPY 6

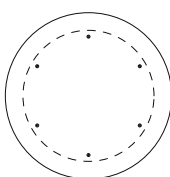

ø 66 cm  
ø 26 in

ROUND CANOPY 8

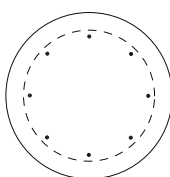

ø 66 cm  
ø 26 in

ROUND CANOPY 12

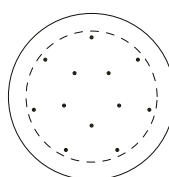

ø 66 cm  
ø 26 in

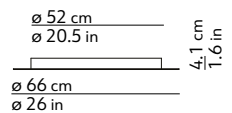

COMPATIBLE LAMP	N. LAMPS	CODE	COLOUR	PRICE VAT excl. *
DEW	6 / 8 / 12	0451371CREU	chrome	<b>310 €</b>
		0451371NEU	black	<b>339 €</b>
		0451371OEU	brass	
FLOOB CEILING	6	0181634TREU	transparent	<b>490 €</b>
KUSHI 16 SUSPENSION	6 / 8 / 12	K226105N	black	<b>270 €</b>
		K226105O	brass	
		K226105R	copper	
KUSHI 33 SUSPENSION	6 / 8	K221105N	black	<b>446 €</b>
		K221105O	brass	
		K221105R	copper	
KUSHI XL SUSPENSION	6	K218105N	black	<b>643 €</b>
		K218105O	brass	
		K218105R	copper	
LILLI	6 / 8	K355365O	brass	<b>621 €</b>
NEW YORK 33	6 / 8	K090261MB	white	<b>362 €</b>
		K090261MC	grey chrome	
		K090261MR	red	
NEW YORK 45	6	K090261LB	white	<b>513 €</b>
		K090261LC	grey chrome	
		K090261LR	red	
OPYO SUSPENSION	6 / 8 / 12	K350356B	white	<b>358 €</b>
		K350356C	coral	
		K350356O	brass	
SPILLO CEILING	6 / 8 / 12	232135EU	white	<b>356 €</b>
YUMA	6 / 8 / 12	370310EU	brass	<b>310 €</b>

\* price for 1 lamp

## ROUND CANOPY 106

CODE	COLOUR	PRICE VAT excl.
<b>ROUND CANOPY 10</b>		
500509B	white	<b>840 €</b>
500509MI	mirrored	<b>1100 €</b>
<b>ROUND CANOPY 16</b>		
500510B	white	<b>940 €</b>
500510MI	mirrored	<b>1200 €</b>
<b>ROUND CANOPY 24</b>		
500511B	white	<b>1250 €</b>
500511MI	mirrored	<b>1360 €</b>

### FEEDING

220-240 V

### CERTIFICATIONS

⊕ IP20 CE ENEC

### MATERIALS

#### INTERNAL CANOPY

metal - white RAL9010

#### CANOPY COVER

metal - mirrored or white RAL9010

### PACKAGING

#### BOX 1

gross w. 15 kg / 33.07 lbs  
 vol. 0.144 m<sup>3</sup> / 5.085 ft<sup>3</sup>  
 dim. L 120 x W 120 x H 10 cm  
 L 47.2 x W 47.2 x H 3.9 in

ROUND CANOPY 10

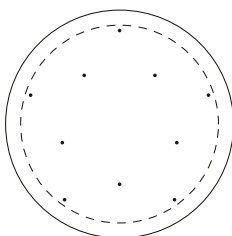

ø 106 cm  
ø 41.7 in

ROUND CANOPY 16

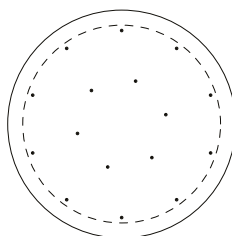

ø 106 cm  
ø 41.7 in

ROUND CANOPY 24

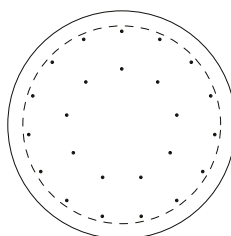

ø 106 cm  
ø 41.7 in

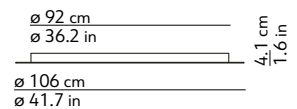

ø 106 cm  
ø 41.7 in

COMPATIBLE LAMP	N. LAMPS	CODE	COLOUR	PRICE VAT excl. *
DEW	10 / 16 / 24	0451371CREU	chrome	<b>310 €</b>
		0451371NEU	black	<b>339 €</b>
		0451371OEU	brass	
FLOOB CEILING	10	0181634TREU	transparent	<b>490 €</b>
KUSHI 16 SUSPENSION	10 / 16 / 24	K226105N	black	<b>270 €</b>
		K226105O	brass	
		K226105R	copper	
KUSHI 33 SUSPENSION	10 / 16 / 24	K221105N	black	<b>446 €</b>
		K221105O	brass	
		K221105R	copper	
KUSHI XL SUSPENSION	10	K218105N	black	<b>643 €</b>
		K218105O	brass	
		K218105R	copper	
LILLI	10 / 16 / 24	K355365O	brass	<b>621 €</b>
NEW YORK 33	10 / 16 / 24	K090261MB	white	<b>362 €</b>
		K090261MC	grey chrome	
		K090261MR	red	
NEW YORK 45	10	K090261LB	white	<b>513 €</b>
		K090261LC	grey chrome	
		K090261LR	red	
OPYO SUSPENSION	10 / 16 / 24	K350356B	white	<b>358 €</b>
		K350356C	coral	
		K350356O	brass	
SPILLO CEILING	10 / 16 / 24	232135EU	white	<b>356 €</b>
YUMA	10 / 16 / 24	370310EU	brass	<b>310 €</b>

\* price for 1 lamp

# ATOMIUM CEILING

HOPF&WORTMANN - BÜRO FÜR FORM, 2006



CODE	COLOUR	PRICE VAT excl.
011892BIEU	white	555 €

**LIGHT SOURCE\***

6x40W max - E14 (E12)

**FEEDING**

220-240 / 120 V

**DIMMABLE**

yes

**LIGHT DIRECTION**



**CERTIFICATIONS**

⊕ IP20 CE ENE

**MATERIALS**

polyethylene

**CABLE LENGTH**

180 cm / 70.9 in

**CANOPY**

white

**PACKAGING**

**BOX 1**

gross w. 8.1 kg / 17.82 lbs  
 vol. 0.199 m<sup>3</sup> / 7.042 ft<sup>3</sup>  
 dim. L 65 x W 59 x H 52 cm  
 L 25.6 x W 23.2 x H 20.5 in



white

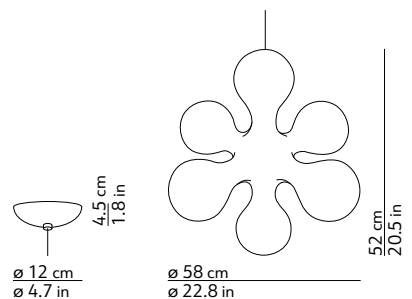

# BOLHA

VALERIO SOMMELLA & ANONIMA LUCI, 2021



CODE	COLOUR	PRICE VAT excl.
K502419A	amber	<b>1350 €</b>
K502419F	smokey brown	

**LIGHT SOURCE\***

board LED 1x19W  
2700 K - 2200 lm - CRI>90

**FEEDING**

220-240 / 120 V

**DIMMABLE**

phase cut

**LIGHT DIRECTION**



**CERTIFICATIONS**

⊕ IP20 CE ENEC

**MATERIALS**

glass + aluminium

**CABLE LENGTH**

180 cm / 70.9 in

**CANOPY**

brown

**PACKAGING**

**BOX 1**

gross w. 2.6 kg / 5.73 lbs  
vol. 0.088 m<sup>3</sup> / 3.090 ft<sup>3</sup>  
dim. L 50 x W 50 x H 35 cm  
L 19.7 x W 19.7 x H 13.8 in

**BOX 2**

gross w. 2 kg / 4.41 lbs  
vol. 0.018 m<sup>3</sup> / 0.636 ft<sup>3</sup>  
dim. L 45 x W 20 x H 20 cm  
L 17.7 x W 7.9 x H 7.9 in



amber

smokey brown

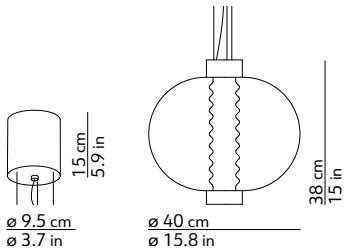

SUSPENSION

\* included



# CLOVER

BRODIE NEILL, 2011



CODE	COLOUR	PRICE VAT excl.
140049LED	white	1630 €

## LIGHT SOURCE\*

board LED 1x20W  
2700 K - 2600 lm - CRI>80  
(110-120 V: board LED 1x15W  
2700 K - 1600 lm - CRI>80)

## FEEDING

110-240 V

## DIMMABLE

1-10V or push

## LIGHT DIRECTION



## CERTIFICATIONS

⊕ IP20 CE ENEC

## MATERIALS

polyurethane + aluminium

## CABLE LENGTH

180 cm / 70.9 in

## CANOPY

white RAL9016

## PACKAGING

### BOX 1

gross w. 18.46 kg / 40.7 lbs  
vol. 0.336 m<sup>3</sup> / 11.866 ft<sup>3</sup>  
dim. L 80 x W 80 x H 52.5 cm  
L 31.5 x W 31.5 x H 20.7 in



white RAL9016

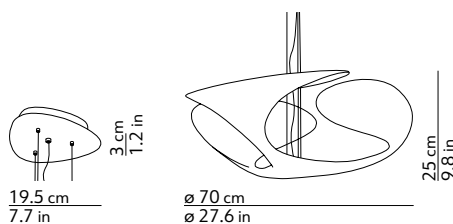

# DALA

FRANCESCA SMIRAGLIA, 2021



CODE	COLOUR	PRICE VAT excl.
<b>2700 K</b>	<b>3000 K**</b>	
K503420GL / K503420GL30	dark grey + wood finish	<b>780 €</b>
K503420SL / K503420SL30	sand + wood finish	
K503420GC / K503420GC30	dark grey + concrete finish	
K503420SC / K503420SC30	sand + concrete finish	
K503420GR / K503420GR30	dark grey + copper	
K503420SR / K503420SR30	sand + copper	

\*\* on request

### LIGHT SOURCE\*

board LED 1x42W  
2700 K - 4200 lm - CRI>90

### DALA 3000 K

board LED 1x42W  
3000 K - 4350 lm - CRI>90

### FEEDING

220-240 / 120 V

### DIMMABLE

phase cut

### LIGHT DIRECTION



dark grey  
+ wood finish



dark grey  
+ concrete finish



dark grey  
+ copper 221



sand  
+ wood finish



sand  
+ concrete finish



sand  
+ copper 221

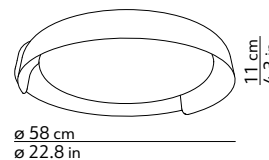

SUSPENSION

\* included

# DALA LINEAR

FRANCESCA SMIRAGLIA, 2022



CODE	COLOUR	PRICE VAT excl.
<b>2700 K</b>		
<b>3000 K**</b>		
K503427GL / K503427GL30	dark grey + wood finish	<b>860 €</b>
K503427SL / K503427SL30	sand + wood finish	
K503427GC / K503427GC30	dark grey + concrete finish	
K503427SC / K503427SC30	sand + concrete finish	
K503427GR / K503427GR30	dark grey + copper	
K503427SR / K503427SR30	sand + copper	

\*\* on request

### LIGHT SOURCE\*

board LED 1x42W  
2700 K - 5150 lm - CRI>90

### DALA LINEAR 3000 K

board LED 1x42W  
3000 K - 5300 lm - CRI>90

### FEEDING

220-240 / 120 V

### DIMMABLE

phase cut

### LIGHT DIRECTION



### CERTIFICATIONS

⊕ IP20 CE ENEC

### MATERIALS

metal

### CABLE LENGTH

180 cm / 70.9 in

### CANOPY

dark grey or sand

### PACKAGING

#### BOX 1 / BOX 2

gross w. 2.4 kg / 5.29 lbs  
vol. 0.011 m<sup>3</sup> / 0.389 ft<sup>3</sup>  
dim. L 130 x W 9 x H 9 cm  
L 51.2 x W 3.5 x H 3.5 in

#### BOX 3

gross w. 4 kg / 8.82 lbs  
vol. 0.023 m<sup>3</sup> / 0.812 ft<sup>3</sup>  
dim. L 150 x W 17 x H 7 cm  
L 59.1 x W 6.7 x H 2.8 in

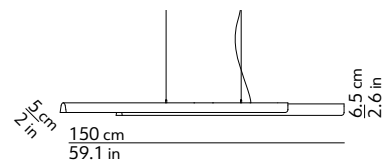
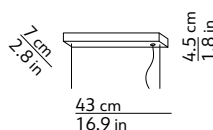

# DEW

EMMANUEL BABLED, 2009



CODE	COLOUR	PRICE VAT excl.
<b>DEW</b>		
0451291EU	chrome	<b>345 €</b>
0451291NEU	black	<b>378 €</b>
0451291OEU	brass	
<b>DEW FALSE CEILING</b>		
0451291C	chrome	<b>378 €</b>
0451291CN	black	
0451291CO	brass	

## LIGHT SOURCE\*

board LED 1x5W  
 2700 K - 440 lm - CRI>90

## FEEDING

220-240 / 120 V

## DIMMABLE

phase cut

## LIGHT DIRECTION



## CERTIFICATIONS

### DEW

⊕ IP20 CE ENEC

### DEW FALSE CEILING

⊕ IP20 CE ENEC

## MATERIALS

glass + aluminium

## CABLE LENGTH

250 cm / 98.4 in

## CANOPY

chromed  
 or black  
 or brass

## PACKAGING

### BOX 1

gross w. 2.34 kg / 5.15 lbs  
 vol. 0.009 m<sup>3</sup> / 0.303 ft<sup>3</sup>  
 dim. L 18.5 x W 16 x H 29 cm  
 L 7.3 x W 6.3 x H 11.4 in



chrome

black RAL9005

brass 205

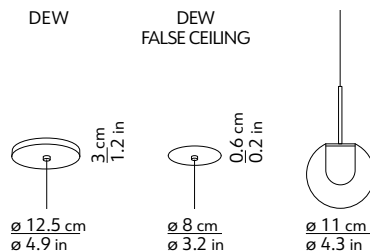

DEW

DEW  
FALSE CEILING

3 cm  
1.2 in  
 ø 12.5 cm  
ø 4.9 in

0.6 cm  
0.2 in  
 ø 8 cm  
ø 3.2 in

ø 11 cm  
ø 4.3 in

# DEW 3

EMMANUEL BABLED, 2009



CODE	COLOUR	PRICE VAT excl.
0451293EU	chrome	999 €
0451293NEU	black	1099 €
0451293OEU	brass	

### LIGHT SOURCE\*

board LED 3x5W  
2700 K - 1320 lm - CRI>90

### FEEDING

220-240 / 120 V

### DIMMABLE

phase cut

### LIGHT DIRECTION



### CERTIFICATIONS

⊕ IP20 CE ENEC

### MATERIALS

glass + aluminium

### CABLE LENGTH

250 cm / 98.4 in

### CANOPY

chromed  
or black  
or brass

### PACKAGING

#### BOX 1

gross w. 6.72 kg / 14.78 lbs  
vol. 0.022 m<sup>3</sup> / 0.788 ft<sup>3</sup>  
dim. L 26 x W 26 x H 33 cm  
L 10.2 x W 10.2 x H 13 in



chrome



black RAL9005



brass 205

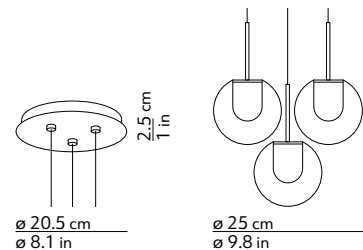

# DEW 5 CHANDELIER

EMMANUEL BABLED, 2009



CODE	COLOUR	PRICE VAT excl.
K0451375EU	chrome	2155 €
K0451375NEU	black	2371 €
K0451375OEU	brass	

## LIGHT SOURCE\*

board LED 5x5W  
2700 K - 2200 lm - CRI>90

## FEEDING

220-240 / 120 V

## DIMMABLE

phase cut

## SPECIAL REQUESTS

It is possible to ask for quotes for different shapes, sizes and finishing according to your needs.

## LIGHT DIRECTION



## CERTIFICATIONS

⊕ IP20 CE ENEC

## MATERIALS

glass + aluminium

## CABLE LENGTH

450 cm / 177.2 in

## NET WEIGHT

10 kg / 22 lbs

## CANOPY

**INTERNAL CANOPY**  
metal - black RAL9005

## CANOPY COVER

mirrored plexiglas  
or black  
or brass

## PACKAGING

### BOX 1-5

gross w. 2.34 kg / 5.15 lbs  
vol. 0.009 m<sup>3</sup> / 0.303 ft<sup>3</sup>  
dim. L 18.5 x W 16 x H 29 cm  
L 7.3 x W 6.3 x H 11.4 in

### BOX 6

gross w. 2.5 kg / 5.51 lbs  
vol. 0.015 m<sup>3</sup> / 0.523 ft<sup>3</sup>  
dim. L 38.5 x W 38.5 x H 10 cm  
L 15.2 x W 15.2 x H 3.9 in



chrome



black RAL9005



brass 205

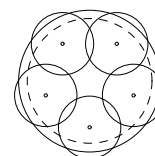

ø 25 cm  
ø 9.8 in

DEWx5

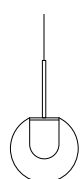

ø 11 cm  
ø 4.3 in

# DEW 7 CHANDELIER

EMMANUEL BABLED, 2009



CODE	COLOUR	PRICE VAT excl.
K0451377EU	chrome	2905 €
K0451377NEU K0451377OEU	black brass	3196 €

## LIGHT SOURCE\*

board LED 7x5W  
2700 K - 3080 lm - CRI>90

## FEEDING

220-240 / 120 V

## DIMMABLE

phase cut

## SPECIAL REQUESTS

It is possible to ask for quotes for different shapes, sizes and finishing according to your needs.

## LIGHT DIRECTION



## CERTIFICATIONS

⊕ IP20 CE ENEC

## MATERIALS

glass + aluminium

## CABLE LENGTH

450 cm / 177.2 in

## NET WEIGHT

13.6 kg / 29.92 lbs

## CANOPY

**INTERNAL CANOPY**  
metal - black RAL9005

## CANOPY COVER

mirrored plexiglas  
or black  
or brass

## PACKAGING

### BOX 1-7

gross w. 2.34 kg / 5.15 lbs

vol. 0.009 m<sup>3</sup> / 0.303 ft<sup>3</sup>

dim. L 18.5 x W 16 x H 29 cm  
L 7.3 x W 6.3 x H 11.4 in

### BOX 8

gross w. 2.5 kg / 5.51 lbs

vol. 0.015 m<sup>3</sup> / 0.523 ft<sup>3</sup>

dim. L 38.5 x W 38.5 x H 10 cm  
L 15.2 x W 15.2 x H 3.9 in



chrome



black RAL9005



brass 205

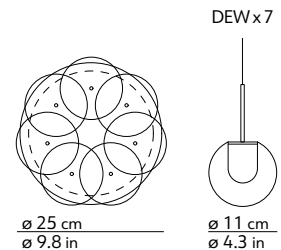

# DEW 9 CHANDELIER

EMMANUEL BABLED, 2009



CODE	COLOUR	PRICE VAT excl.
K0451379EU	chrome	4250 €
K0451379NEU	black	4675 €
K0451379OEU	brass	

## LIGHT SOURCE\*

board LED 9x5W  
2700 K - 3960 lm - CRI>90

## FEEDING

220-240 / 120 V

## DIMMABLE

phase cut

## SPECIAL REQUESTS

It is possible to ask for quotes for different shapes, sizes and finishing according to your needs.

## LIGHT DIRECTION



## CERTIFICATIONS

⊕ IP20 CE ENE

## MATERIALS

glass + aluminium

## CABLE LENGTH

450 cm / 177.2 in

## NET WEIGHT

18 kg / 39.6 lbs

## CANOPY

**INTERNAL CANOPY**  
metal - black RAL9005

## CANOPY COVER

mirrored plexiglas  
or black  
or brass

## PACKAGING

### BOX 1-9

gross w. 2.34 kg / 5.15 lbs  
vol. 0.009 m<sup>3</sup> / 0.303 ft<sup>3</sup>  
dim. L 18.5 x W 16 x H 29 cm  
L 7.3 x W 6.3 x H 11.4 in

### BOX 10

gross w. 4 kg / 8.82 lbs  
vol. 0.035 m<sup>3</sup> / 1.250 ft<sup>3</sup>  
dim. L 59.5 x W 59.5 x H 10 cm  
L 23.4 x W 23.4 x H 3.9 in



chrome

black RAL9005

brass 205

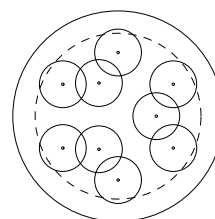

ø 49.5 cm  
ø 19.5 in

DEW x9

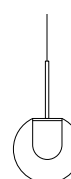

ø 11 cm  
ø 4.3 in



# DEW 15 CHANDELIER

EMMANUEL BABLED, 2009



CODE	COLOUR	PRICE VAT excl.
K04513715EU	chrome	<b>6550 €</b>
K04513715NEU K04513715OEU	black brass	<b>7206 €</b>

## LIGHT SOURCE\*

board LED 15x5W  
2700 K - 6600 lm - CRI>90

## FEEDING

220-240 / 120 V

## DIMMABLE

phase cut

## SPECIAL REQUESTS

It is possible to ask for quotes for different shapes, sizes and finishing according to your needs.

## LIGHT DIRECTION



## CERTIFICATIONS

⊕ IP20 CE ENE

## MATERIALS

glass + aluminium

## CABLE LENGTH

450 cm / 177.2 in

## NET WEIGHT

28.8 kg / 63.36 lbs

## CANOPY

**INTERNAL CANOPY**  
metal - black RAL9005

## CANOPY COVER

mirrored plexiglas  
or black  
or brass

## PACKAGING

### BOX 1-15

gross w. 2.34 kg / 5.15 lbs

vol. 0.009 m<sup>3</sup> / 0.303 ft<sup>3</sup>

dim. L 18.5 x W 16 x H 29 cm

L 7.3 x W 6.3 x H 11.4 in

### BOX 16

gross w. 4 kg / 8.82 lbs

vol. 0.035 m<sup>3</sup> / 1.250 ft<sup>3</sup>

dim. L 59.5 x W 59.5 x H 10 cm

L 23.4 x W 23.4 x H 3.9 in



chrome



black RAL9005



brass 205

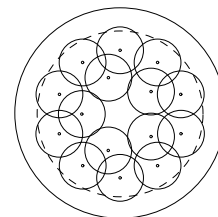

ø 49.5 cm  
ø 19.5 in

DEW x 15

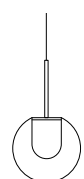

ø 11 cm  
ø 4.3 in

# DEW 19 CHANDELIER

EMMANUEL BABLED, 2009



CODE	COLOUR	PRICE VAT excl.
K04513719EU	chrome	<b>8046 €</b>
K04513719NEU K04513719OEU	black brass	<b>8851 €</b>

## LIGHT SOURCE\*

board LED 19x5W  
2700 K - 8360 lm - CRI>90

## FEEDING

220-240 / 120 V

## DIMMABLE

phase cut

## SPECIAL REQUESTS

It is possible to ask for quotes for different shapes, sizes and finishing according to your needs.

## LIGHT DIRECTION



## CERTIFICATIONS

⊕ IP20 CE ENEC

## MATERIALS

glass + aluminium

## CABLE LENGTH

450 cm / 177.2 in

## NET WEIGHT

36 kg / 79.2 lbs

## CANOPY

**INTERNAL CANOPY**  
metal - black RAL9005

## CANOPY COVER

mirrored plexiglas  
or black  
or brass

## PACKAGING

### BOX 1-19

gross w. 2.34 kg / 5.15 lbs  
vol. 0.009 m<sup>3</sup> / 0.303 ft<sup>3</sup>  
dim. L 18.5 x W 16 x H 29 cm  
L 7.3 x W 6.3 x H 11.4 in

### BOX 20

gross w. 4 kg / 8.82 lbs  
vol. 0.035 m<sup>3</sup> / 1.250 ft<sup>3</sup>  
dim. L 59.5 x W 59.5 x H 10 cm  
L 23.4 x W 23.4 x H 3.9 in



chrome

black RAL9005

brass 205

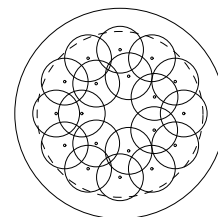

ø 49.5 cm  
ø 19.5 in

DEW x 19

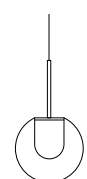

ø 11 cm  
ø 4.3 in

# E.T.A. SAT

GUGLIELMO BERCHICCI, 1996



CODE	COLOUR	PRICE VAT excl.
<b>E.T.A. SAT</b>		
017106BIEU	white	<b>1040 €</b>
017106AREU	orange	
<b>E.T.A. SAT GIANT **</b>		
017132GBIEU	white	<b>2930 €</b>
017132GAREU	orange	

\*\* on request

## LIGHT SOURCE\*

### E.T.A. SAT

1x40W max - E14 (E12) +  
1x100W max - E27 (E26)

### E.T.A. SAT GIANT

6x21W max - E27 (E26) +  
2x16W max - E27 (E26)

## FEEDING

220-240 / 120 V

## DIMMABLE

yes

## LIGHT DIRECTION



white



orange

## CERTIFICATIONS

⊕ IP20 CE ENEC

## MATERIALS

fiberglass + polycarbonate + metal

## CABLE LENGTH

180 cm / 70.9 in

## CANOPY

white

## PACKAGING

### E.T.A. SAT

#### BOX 1

gross w. 7.9 kg / 17.38 lbs  
vol. 0.316 m<sup>3</sup> / 11.149 ft<sup>3</sup>  
dim. L 67 x W 76 x H 62 cm  
L 26.4 x W 29.9 x H 24.4 in

### E.T.A. SAT GIANT

#### BOX 1

gross w. 20 kg / 44.1 lbs  
vol. 2.671 m<sup>3</sup> / 94.332 ft<sup>3</sup>  
dim. L 168 x W 132.5 x H 120 cm  
L 66.1 x W 52.2 x H 47.2 in

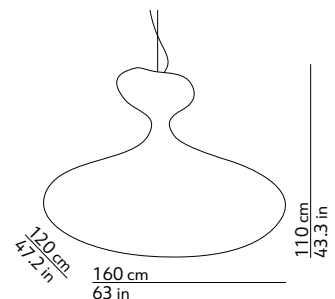
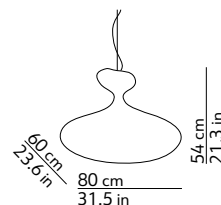
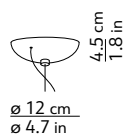

# FLOED

## STORAGEMILANO, 2020



CODE	COLOUR	PRICE VAT excl.
K375416BR	bronze	842 €

### LIGHT SOURCE\*

1x70W max - E27 (E26)  
L 10.5cm max

### FEEDING

220-240 / 120 V

### DIMMABLE

yes

### LIGHT DIRECTION



### CERTIFICATIONS

⊕ IP20 CE ENE

### MATERIALS

glass + aluminium

### PACKAGING

#### BOX 1

gross w. 2.5 kg / 5.5 lbs  
vol. 0.018 m<sup>3</sup> / 0.644 ft<sup>3</sup>  
dim. L 32 x W 32 x H 25 cm  
L 12.6 x W 12.6 x H 9.8 in

#### BOX 2

gross w. 2.85 kg / 6.27 lbs  
vol. 0.050 m<sup>3</sup> / 1.777 ft<sup>3</sup>  
dim. L 89 x W 29 x H 19.5 cm  
L 35 x W 11.4 x H 7.7 in



bronze

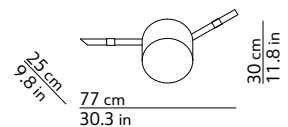

# FLOED 2

STORAGEMILANO, 2020



CODE	COLOUR	PRICE VAT excl.
K375417BR	bronze	1447 €

**LIGHT SOURCE\***

2x70W max - E27 (E26)  
L 10.5cm max

**FEEDING**

220-240 / 120 V

**DIMMABLE**

yes

**LIGHT DIRECTION**



**CERTIFICATIONS**

⊕ IP20 CE ENEC

**MATERIALS**

glass + aluminium

**PACKAGING**

BOX 1 / BOX 2

gross w. 2.5 kg / 5.5 lbs  
vol. 0.018 m<sup>3</sup> / 0.644 ft<sup>3</sup>  
dim. L 32 x W 32 x H 25 cm  
L 12.6 x W 12.6 x H 9.8 in

BOX 3

gross w. 5.1 kg / 11.22 lbs  
vol. 0.107 m<sup>3</sup> / 3.781 ft<sup>3</sup>  
dim. L 161.5 x W 34 x H 19.5 cm  
L 63.4 x W 13.4 x H 7.7 in



bronze

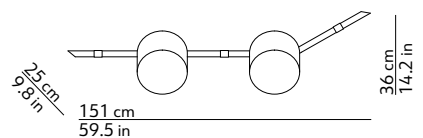

# FLOOB CEILING

KARIM RASHID, 2005



CODE	COLOUR	PRICE VAT excl.
0181634TREU	transparent	490 €

## LIGHT SOURCE\*

1x100W max - E27 (E26)

## FEEDING

220-240 / 120 V

## DIMMABLE

yes

## LIGHT DIRECTION



## CERTIFICATIONS

⊕ IP20 CE ENEC

## MATERIALS

plexiglas + aluminium

## CABLE LENGTH

180 cm / 70.9 in

## CANOPY

white

## PACKAGING

### BOX 1

gross w. 4.36 kg / 9.59 lbs

vol. 0.146 m<sup>3</sup> / 5.171 ft<sup>3</sup>

dim. L 46.5 x W 47 x H 67 cm  
L 18.3 x W 18.5 x H 26.4 in



transparent

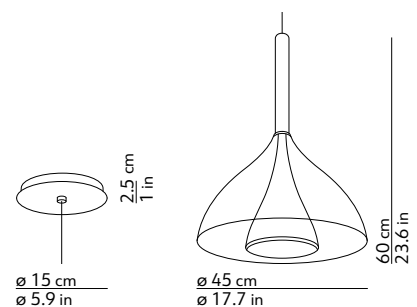

SUSPENSION

\* not included

# FLOW

CHRIS BASIAS, 2022



CODE	COLOUR	PRICE VAT excl.
506428N	black	220 €
<b>ACCESSORIES</b>		
500500N	black canopy	64 €
500501N	black false ceiling canopy	38 €
500517N**	black multiple canopy	230 €
<b>LEAF</b>		
506430N	black	105 €

\*\* max 8 lamps. Decentralizers included

**LIGHT SOURCE\***

1x25W max - G9

**FEEDING**

220-240 / 120 V

**DIMMABLE**

yes

**LIGHT DIRECTION**



**CERTIFICATIONS**

⊕ IP20 CE ENEC

**MATERIALS**

glass + metal

**CABLE LENGTH**

180 cm / 70.9 in

**CANOPY**

black RAL9005

**PACKAGING**

**BOX 1**

gross w. 2.1 kg / 4.63 lbs  
 vol. 0.028 m<sup>3</sup> / 0.989 ft<sup>3</sup>  
 dim. L 42 x W 42 x H 16 cm  
 L 16.5 x W 16.5 x H 6.3 in

**LEAF**

**BOX 1**

gross w. 1.4 kg / 3.09 lbs  
 vol. 0.028 m<sup>3</sup> / 0.989 ft<sup>3</sup>  
 dim. L 42 x W 42 x H 16 cm  
 L 16.5 x W 16.5 x H 6.3 in



black RAL9005

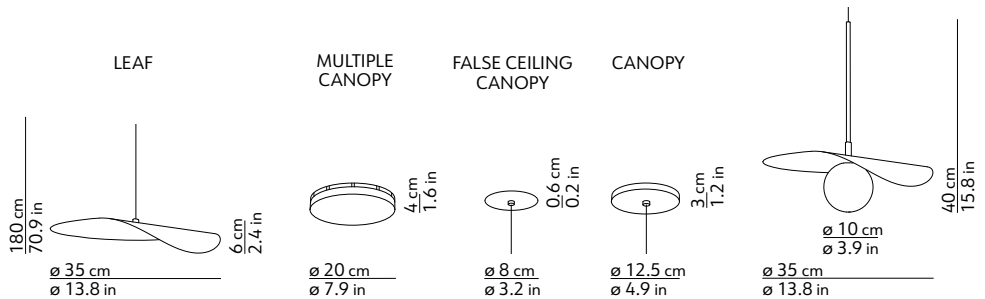

# FLOW CEILING

CHRIS BASIAS, 2022



CODE	COLOUR	PRICE VAT excl.
506429N	black	<b>230 €</b>
<b>LEAF</b>		
506430N	black	<b>105 €</b>

**LIGHT SOURCE\***

1x25W max - G9

**FEEDING**

220-240 / 120 V

**DIMMABLE**

yes

**LIGHT DIRECTION**



**CERTIFICATIONS**

⊕ IP20 CE ENEC

**MATERIALS**

glass + metal

**PACKAGING**

**BOX 1**

gross w. 1.9 kg / 4.19 lbs  
 vol. 0.028 m<sup>3</sup> / 0.989 ft<sup>3</sup>  
 dim. L 42 x W 42 x H 16 cm  
 L 16.5 x W 16.5 x H 6.3 in

**LEAF**

**BOX 1**

gross w. 1.4 kg / 3.09 lbs  
 vol. 0.028 m<sup>3</sup> / 0.989 ft<sup>3</sup>  
 dim. L 42 x W 42 x H 16 cm  
 L 16.5 x W 16.5 x H 6.3 in



black RAL9005

LEAF

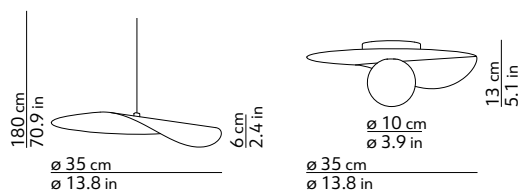

**SUSPENSION**

\* not included



# GIASS 25

SEBASTIAN HERKNER, 2017



CODE	COLOUR	PRICE VAT excl.
K395330S	white	<b>1250 €</b>
K395330G	smokey grey	

### LIGHT SOURCE\*

board LED 1x19W  
2700 K - 1700 lm - CRI>90

### FEEDING

100-240 V

### DIMMABLE

0-10V

### LIGHT DIRECTION



### CERTIFICATIONS

⊕ IP20 CE ENEC

### MATERIALS

glass + metal

### PACKAGING

#### BOX 1

gross w. 5.2 kg / 11.5 lbs  
vol. 0.056 m<sup>3</sup> / 1.962 ft<sup>3</sup>  
dim. L 31.5 x W 31.5 x H 56 cm  
L 12.4 x W 12.4 x H 22.1 in

#### BOX 2

gross w. 2.1 kg / 4.6 lbs  
vol. 0.009 m<sup>3</sup> / 0.312 ft<sup>3</sup>  
dim. L 30.5 x W 30.5 x H 9.5 cm  
L 12 x W 12 x H 3.7 in



white



smokey grey

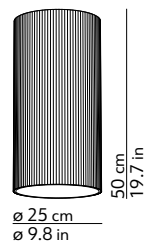

# GIASS 30

SEBASTIAN HERKNER, 2017



CODE	COLOUR	PRICE VAT excl.
K396330S	white	<b>1375 €</b>
K396330G	smokey grey	

## LIGHT SOURCE\*

board LED 1x25W  
2700 K - 2250 lm - CRI>90

## FEEDING

100-240 V

## DIMMABLE

0-10V

## LIGHT DIRECTION



## CERTIFICATIONS

⊕ IP20 CE ENEC

## MATERIALS

glass + metal

## PACKAGING

### BOX 1

gross w. 5.5 kg / 12.1 lbs  
vol. 0.064 m<sup>3</sup> / 2.258 ft<sup>3</sup>  
dim. L 36.5 x W 36.5 x H 48 cm  
L 14.4 x W 14.4 x H 18.9 in

### BOX 2

gross w. 2.7 kg / 6 lbs  
vol. 0.011 m<sup>3</sup> / 0.388 ft<sup>3</sup>  
dim. L 34 x W 34 x H 9.5 cm  
L 13.4 x W 13.4 x H 3.7 in



white



smokey grey

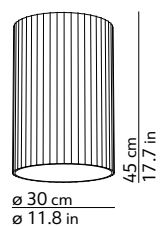

# GIASS 40

SEBASTIAN HERKNER, 2017



CODE	COLOUR	PRICE VAT excl.
K397330S	white	<b>1495 €</b>
K397330G	smokey grey	

### LIGHT SOURCE\*

board LED 1x35W  
2700 K - 3100 lm - CRI>90

### FEEDING

100-240 V

### DIMMABLE

0-10V

### LIGHT DIRECTION



### CERTIFICATIONS

⊕ IP20 CE ENEC

### MATERIALS

glass + metal

### PACKAGING

#### BOX 1

gross w. 5.8 kg / 12.8 lbs  
vol. 0.090 m<sup>3</sup> / 3.169 ft<sup>3</sup>  
dim. L 46.5 x W 46.5 x H 41.5 cm  
L 18.3 x W 18.3 x H 16.3 in

#### BOX 2

gross w. 4.2 kg / 9.3 lbs  
vol. 0.018 m<sup>3</sup> / 0.650 ft<sup>3</sup>  
dim. L 44 x W 44 x H 9.5 cm  
L 17.3 x W 17.3 x H 3.7 in



white



smokey grey

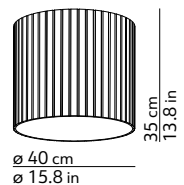

# GIASS 50

SEBASTIAN HERKNER, 2017



CODE	COLOUR	PRICE VAT excl.
K398330S	white	<b>1566 €</b>
K398330G	smokey grey	

### LIGHT SOURCE\*

board LED 1x44W  
2700 K - 3950 lm - CRI>90

### FEEDING

100-240 V

### DIMMABLE

0-10V

### LIGHT DIRECTION



### CERTIFICATIONS

⊕ IP20 CE ENEC

### MATERIALS

glass + metal

### PACKAGING

#### BOX 1

gross w. 5.2 kg / 11.5 lbs  
vol. 0.099 m<sup>3</sup> / 3.495 ft<sup>3</sup>  
dim. L 56.5 x W 56.5 x H 31 cm  
L 22.2 x W 22.2 x H 12.2 in

#### BOX 2

gross w. 6.5 kg / 14.3 lbs  
vol. 0.028 m<sup>3</sup> / 0.991 ft<sup>3</sup>  
dim. L 54.5 x W 54.5 x H 9.5 cm  
L 21.5 x W 21.5 x H 3.7 in



white



smokey grey

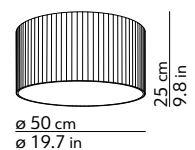

# JER

VALERIO SOMMELLA & ANONIMA LUCI, 2021



CODE	COLOUR	PRICE VAT excl.
K504421FB	smokey blue	<b>585 €</b>
K504421FM	smokey brown	
K504421FV	smokey green	

## LIGHT SOURCE\*

board LED 1x4.5W  
2700 K - 540 lm - CRI>80

## FEEDING

220-240 / 120 V

## DIMMABLE

phase cut

## LIGHT DIRECTION



## CERTIFICATIONS

⊕ IP20 CE ENEC

## MATERIALS

glass + metal

## CABLE LENGTH

180 cm / 70.9 in

## CANOPY

black 9005

## PACKAGING

### BOX 1

gross w. 1.8 kg / 3.97 lbs  
vol. 0.015 m<sup>3</sup> / 0.530 ft<sup>3</sup>  
dim. L 60 x W 16 x H 16 cm  
L 23.6 x W 6.3 x H 6.3 in

### BOX 2

gross w. 0.58 kg / 1.28 lbs  
vol. 0.002 m<sup>3</sup> / 0.071 ft<sup>3</sup>  
dim. L 13 x W 13 x H 11 cm  
L 5.1 x W 5.1 x H 4.3 in



smokey blue



smokey brown



smokey green

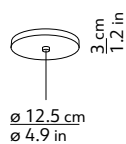

# KUSHI 16 CEILING

ALBERTO SAGGIA & VALERIO SOMMELLA, 2015



CODE	COLOUR	PRICE VAT excl.
K225105N	black	<b>248 €</b>
K225105O	brass	
K225105R	copper	

## LIGHT SOURCE\*

1x25W max - G9

## FEEDING

220-240 / 120 V

## DIMMABLE

yes

## LIGHT DIRECTION



## CERTIFICATIONS

⊕ IP20 CE ENEC

## MATERIALS

glass + metal

## PACKAGING

### BOX 1

gross w. 0.86 kg / 1.89 lbs  
 vol. 0.011 m<sup>3</sup> / 0.380 ft<sup>3</sup>  
 dim. L 23.5 x W 23.5 x H 19.5 cm  
 L 9.3 x W 9.3 x H 7.7 in

### BOX 2

gross w. 0.4 kg / 0.88 lbs  
 vol. 0.005 m<sup>3</sup> / 0.159 ft<sup>3</sup>  
 dim. L 14 x W 14 x H 23 cm  
 L 5.5 x W 5.5 x H 9.1 in



black RAL9005



brass 205



copper 212

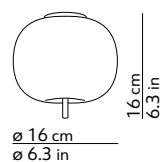

SUSPENSION

\* not included

# KUSHI 33 CEILING

ALBERTO SAGGIA & VALERIO SOMMELLA, 2015



CODE	COLOUR	PRICE VAT excl.
K220105N	black	<b>376 €</b>
K220105O	brass	
K220105R	copper	

## LIGHT SOURCE\*

1x30W max - E27 (E26)

## FEEDING

220-240 / 120 V

## DIMMABLE

yes

## LIGHT DIRECTION



## CERTIFICATIONS

⊕ IP20 CE ENEC

## MATERIALS

glass + metal

## PACKAGING

### BOX 1

gross w. 3.34 kg / 7.35 lbs  
 vol. 0.055 m<sup>3</sup> / 1.949 ft<sup>3</sup>  
 dim. L 40 x W 40 x H 34.5 cm  
 L 15.8 x W 15.8 x H 13.6 in

### BOX 2

gross w. 0.82 kg / 1.8 lbs  
 vol. 0.012 m<sup>3</sup> / 0.411 ft<sup>3</sup>  
 dim. L 18.5 x W 18.5 x H 34 cm  
 L 7.3 x W 7.3 x H 13.4 in



black RAL9005



brass 205



copper 212

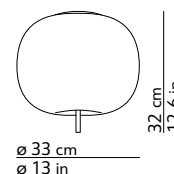

# KUSHI XL CEILING

ALBERTO SAGGIA & VALERIO SOMMELLA, 2022



CODE	COLOUR	PRICE VAT excl.
K217105N	black	<b>540 €</b>
K217105O	brass	
K217105R	copper	

## LIGHT SOURCE\*

2x70W max - E27 (E26)

## FEEDING

220-240 / 120 V

## DIMMABLE

yes

## LIGHT DIRECTION



## CERTIFICATIONS

⊕ IP20 CE ENEC

## MATERIALS

glass + metal

## PACKAGING

### BOX 1

gross w. 4.75 kg / 10.45 lbs  
 vol. 0.103 m<sup>3</sup> / 3.647 ft<sup>3</sup>  
 dim. L 50.5 x W 50.5 x H 40.5 cm  
 L 19.9 x W 19.9 x H 15.9 in

### BOX 2

gross w. 0.95 kg / 2.09 lbs  
 vol. 0.017 m<sup>3</sup> / 0.600 ft<sup>3</sup>  
 dim. L 22.5 x W 22.5 x H 34 cm  
 L 8.9 x W 8.9 x H 13.4 in



black RAL9005

brass 205

copper 212

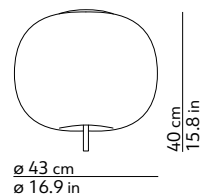

SUSPENSION

\* not included



# KUSHI 16 SUSPENSION

ALBERTO SAGGIA & VALERIO SOMMELLA, 2015



CODE	COLOUR	PRICE VAT excl.
K226105N	black	<b>270 €</b>
K226105O	brass	
K226105R	copper	

## LIGHT SOURCE\*

1x25W max - G9

## FEEDING

220-240 / 120 V

## DIMMABLE

yes

## LIGHT DIRECTION



## CERTIFICATIONS

⊕ IP20 CE ENEC

## MATERIALS

glass + metal

## CABLE LENGTH

180 cm / 70.9 in

## CANOPY

white RAL9010

## PACKAGING

### BOX 1

gross w. 0.86 kg / 1.89 lbs  
 vol. 0.011 m<sup>3</sup> / 0.380 ft<sup>3</sup>  
 dim. L 23.5 x W 23.5 x H 19.5 cm  
 L 9.3 x W 9.3 x H 7.7 in

### BOX 2

gross w. 0.69 kg / 1.52 lbs  
 vol. 0.005 m<sup>3</sup> / 0.159 ft<sup>3</sup>  
 dim. L 14 x W 14 x H 23 cm  
 L 5.5 x W 5.5 x H 9.1 in



black RAL9005

brass 205

copper 212

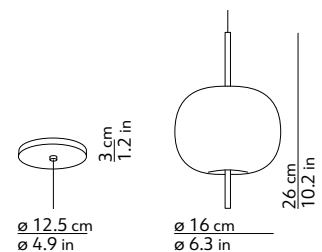

# KUSHI 33 SUSPENSION

ALBERTO SAGGIA & VALERIO SOMMELLA, 2015



CODE	COLOUR	PRICE VAT excl.
K221105N	black	<b>446 €</b>
K221105O	brass	
K221105R	copper	

## LIGHT SOURCE\*

1x30W max - E27 (E26)

## FEEDING

220-240 / 120 V

## DIMMABLE

yes

## LIGHT DIRECTION



## CERTIFICATIONS

⊕ IP20 CE ENEC

## MATERIALS

glass + metal

## CABLE LENGTH

180 cm / 70.9 in

## CANOPY

white RAL9010

## PACKAGING

### BOX 1

gross w. 3.34 kg / 7.35 lbs  
 vol. 0.055 m<sup>3</sup> / 1.949 ft<sup>3</sup>  
 dim. L 40 x W 40 x H 34.5 cm  
 L 15.8 x W 15.8 x H 13.6 in

### BOX 2

gross w. 1.03 kg / 2.27 lbs  
 vol. 0.012 m<sup>3</sup> / 0.411 ft<sup>3</sup>  
 dim. L 18.5 x W 18.5 x H 34 cm  
 L 7.3 x W 7.3 x H 13.4 in



black RAL9005

brass 205

copper 212

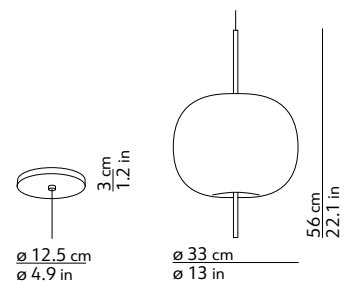

# KUSHI XL SUSPENSION

ALBERTO SAGGIA & VALERIO SOMMELLA, 2019



CODE	COLOUR	PRICE VAT excl.
K218105N	black	<b>643 €</b>
K218105O	brass	
K218105R	copper	

## LIGHT SOURCE\*

2x70W max - E27 (E26)

## FEEDING

220-240 / 120 V

## DIMMABLE

yes

## LIGHT DIRECTION



## CERTIFICATIONS

⊕ IP20 CE ENEC

## MATERIALS

glass + metal

## CABLE LENGTH

180 cm / 70.9 in

## CANOPY

white RAL9010

## PACKAGING

### BOX 1

gross w. 4.75 kg / 10.45 lbs  
 vol. 0.103 m<sup>3</sup> / 3.647 ft<sup>3</sup>  
 dim. L 50.5 x W 50.5 x H 40.5 cm  
 L 19.9 x W 19.9 x H 15.9 in

### BOX 2

gross w. 0.87 kg / 1.91 lbs  
 vol. 0.007 m<sup>3</sup> / 0.252 ft<sup>3</sup>  
 dim. L 14.5 x W 14.5 x H 34 cm  
 L 5.7 x W 5.7 x H 13.4 in

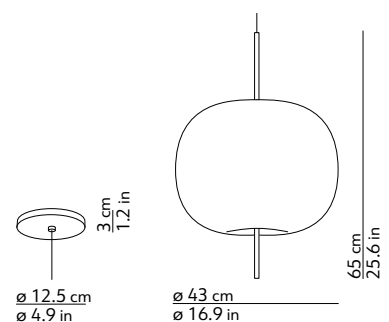

# LANNÀ SUSPENSION

NOÉ DUCHAUFURLAWRANCE, 2017



CODE	COLOUR	PRICE VAT excl.
K386320N	black	<b>440 €</b>
K386320	brass	

## LIGHT SOURCE\*

1x20W max - E27 (E26)  
Ø 6cm max

## FEEDING

220-240 / 120 V

## DIMMABLE

yes

## LIGHT DIRECTION



## CERTIFICATIONS

⊕ IP20 CE ENEC

## MATERIALS

glass + metal

## CABLE LENGTH

180 cm / 70.9 in

## CANOPY

black RAL9005  
or brass 209

## PACKAGING

### BOX 1

gross w. 2.02 kg / 4.44 lbs  
vol. 0.022 m<sup>3</sup> / 0.788 ft<sup>3</sup>  
dim. L 26 x W 26 x H 33 cm  
L 10.2 x W 10.2 x H 13 in

### BOX 2

gross w. 1.74 kg / 3.83 lbs  
vol. 0.026 m<sup>3</sup> / 0.927 ft<sup>3</sup>  
dim. L 44.5 x W 29.5 x H 20 cm  
L 17.5 x W 11.6 x H 7.9 in



black RAL9005

brass 209

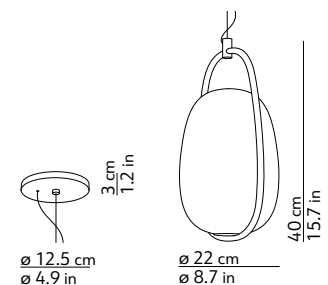

# LILLI

CRISTINA CELESTINO, 2019



CODE	COLOUR	PRICE VAT excl.
K3553650	brass	<b>621€</b>

### LIGHT SOURCE\*

3x42W max - E14 (E12)

### FEEDING

220-240 / 120 V

### DIMMABLE

yes

### LIGHT DIRECTION



### CERTIFICATIONS

⊕ IP20 CE ENEC

### MATERIALS

glass + metal

### CABLE LENGTH

180 cm / 70.9 in

### CANOPY

white RAL9010

### PACKAGING

#### BOX 1

gross w. 4 kg / 8.8 lbs  
 vol. 0.049 m<sup>3</sup> / 1.719 ft<sup>3</sup>  
 dim. L 39 x W 39 x H 32 cm  
 L 15.4 x W 15.4 x H 12.6 in

#### BOX 2

gross w. 1.58 kg / 3.48 lbs  
 vol. 0.006 m<sup>3</sup> / 0.212 ft<sup>3</sup>  
 dim. L 16 x W 16 x H 42 cm  
 L 6.3 x W 6.3 x H 16.5 in



brass 305

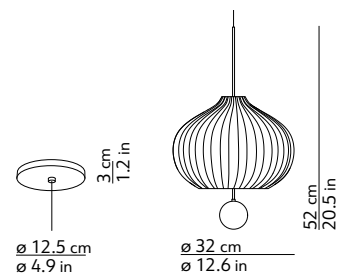

# LOUIS

STUDIO 14, 2013



CODE	COLOUR	PRICE VAT excl.
<b>LOUIS 34</b> K075245	white	<b>367 €</b>
<b>LOUIS 41</b> K075245M	white	<b>389 €</b>
<b>LOUIS 48</b> K075245L	white	<b>410 €</b>

**LIGHT SOURCE\***

1x30W max - E27 (E26)  
Ø 5.5cm max

**FEEDING**

220-240 / 120 V

**DIMMABLE**

yes

**LIGHT DIRECTION**



**CERTIFICATIONS**

⊕ IP20 CE ENEC

**MATERIALS**

polyethylene + aluminium

**PACKAGING**

**BOX 1**

gross w. 5.12 kg / 11.26 lbs  
vol. 0.174 m³ / 6.153 ft³  
dim. L 66 x W 66 x H 40 cm  
L 26 x W 26 x H 15.8 in

**BOX 2**

gross w. 1.14 kg / 2.51 lbs  
vol. 0.007 m³ / 0.244 ft³  
dim. L 27 x W 16 x H 16 cm  
L 10.6 x W 6.3 x H 6.3 in



white

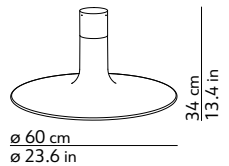
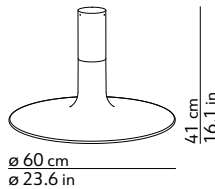
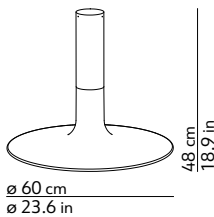

SUSPENSION

\* not included

# MINIMAL

DAVID POMPA, 2017



CODE	COLOUR	PRICE VAT excl.
380315R	copper	<b>235 €</b>
380315N	black nickel	
<b>OPTIONAL</b>		
ALI-CC350_8W	driver (not dimmable)	<b>27 €</b>
500500N	black canopy	<b>64 €</b>

## LIGHT SOURCE\*

board LED 1x3.15W  
2700 K - 410 lm - CRI>80

## FEEDING\*\*

DC 350mA constant current

## DIMMABLE

yes

## LIGHT DIRECTION



## CERTIFICATIONS

### MINIMAL

◆ IP20 CE ENEC

### MINIMAL + DRIVER

□ IP20 CE ENEC

### MINIMAL + OPTIONAL CANOPY

⊕ IP20 CE ENEC

## MATERIALS

ceramic + metal

## CABLE LENGTH

180 cm / 70.9 in

## CANOPY

black RAL9005

## PACKAGING

### BOX 1

gross w. 0.8 kg / 1.76 lbs  
vol. 0.003 m<sup>3</sup> / 0.102 ft<sup>3</sup>  
dim. L 40 x W 8.5 x H 8.5 cm  
L 15.8 x W 3.4 x H 3.4 in



copper 306



black nickel

## OPTIONAL

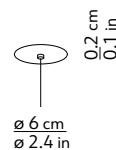
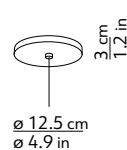

\* included

\*\* driver not included

# MITOS

CHRIS BASIAS, 2022



CODE	COLOUR	PRICE VAT excl.
------	--------	-----------------

507431N	black	195 €
---------	-------	-------

**ACCESSORIES**

507-ALI70N	driver kit (48V - 70W max)	220 €
507-CAV10	copper cable (10m / 32.8ft)	64 €
507-CAV30	copper cable (30m / 98.4ft)	165 €

**LIGHT SOURCE\***  
1x10W max - GU 5.3

**FEEDING**  
100-240 V

**DIMMABLE**  
yes

**LIGHT DIRECTION**



**CERTIFICATIONS**  
◆ IP20 CE ENEC

**MATERIALS**  
aluminium + technopolymer

**DRIVER KIT**  
black RAL9005

**PACKAGING**  
**BOX 1**  
gross w. 1.2 kg / 2.65 lbs  
vol. 0.003 m³ / 0.106 ft³  
dim. L 11 x W 11 x H 23 cm  
L 4.3 x W 4.3 x H 9.1 in

**DRIVER KIT**  
**BOX 1**  
gross w. 2.3 kg / 5.07 lbs  
vol. 0.013 m³ / 0.459 ft³  
dim. L 28 x W 28 x H 17 cm  
L 11 x W 11 x H 6.7 in



black RAL9005

**DRIVER KIT**

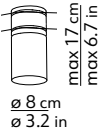
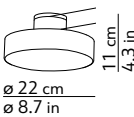

**SUSPENSION**

\* not included



# NAMI

ALBERTO SAGGIA & VALERIO SOMMELLA, 2017



CODE	COLOUR	PRICE VAT excl.
K405340N	black	<b>1760 €</b>
K405340	brass	

### LIGHT SOURCE\*

board LED 4x15W  
2700 K - 2520x2 lm - CRI>90

### FEEDING

100-240 V

### DIMMABLE

1-10V

### LIGHT DIRECTION



### CERTIFICATIONS

⊕ IP20 CE ENEC

### MATERIALS

glass + metal

### CABLE LENGTH

180 cm / 70.9 in

### CANOPY

black RAL9005  
or brass 111

### PACKAGING

#### BOX 1

gross w. 7.4 kg / 16.28 lbs  
vol. 0.075 m<sup>3</sup> / 2.641 ft<sup>3</sup>  
dim. L 130 x W 19.5 x H 29.5 cm  
L 51.2 x W 7.7 x H 11.6 in

#### BOX 2

gross w. 12.6 kg / 27.72 lbs  
vol. 0.019 m<sup>3</sup> / 0.672 ft<sup>3</sup>  
dim. L 160 x W 17 x H 7 cm  
L 63 x W 6.7 x H 2.8 in



black RAL9005

brass 111

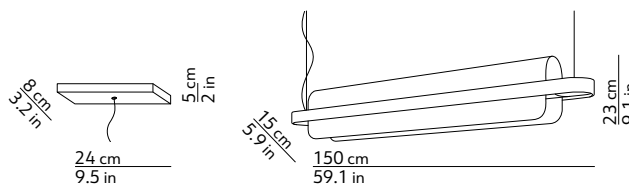

# NEW YORK

PETER JAMIESON, 2013



CODE	COLOUR	PRICE VAT excl.
<b>NEW YORK 33</b>		
K090261MB	white	<b>362 €</b>
K090261MC	grey chrome	
K090261MR	red	
<b>NEW YORK 45</b>		
K090261LB	white	<b>513 €</b>
K090261LC	grey chrome	
K090261LR	red	

## LIGHT SOURCE\*

### NEW YORK 33

1x30W max - E27 (E26)

### NEW YORK 45

3x30W max - E27 (E26)

## FEEDING

220-240 / 120 V

## DIMMABLE

yes

## CERTIFICATIONS

⊕ IP20 CE ENEC

## MATERIALS

technopolymer + methacrylate

## CABLE LENGTH

180 cm / 70.9 in

## CANOPY

chromed

## LIGHT DIRECTION



## PACKAGING

### NEW YORK 33

#### BOX 1

gross w. 1.36 kg / 2.99 lbs  
 vol. 0.009 m<sup>3</sup> / 0.316 ft<sup>3</sup>  
 dim. L 43 x W 104 x H 2 cm  
 L 16.9 x W 40.9 x H 0.8 in

#### BOX 2

gross w. 1.3 kg / 2.86 lbs  
 vol. 0.024 m<sup>3</sup> / 0.862 ft<sup>3</sup>  
 dim. L 34.5 x W 34.5 x H 20.5 cm  
 L 13.6 x W 13.6 x H 7.9 in

### NEW YORK 45

#### BOX 1

gross w. 2.58 kg / 5.68 lbs  
 vol. 0.022 m<sup>3</sup> / 0.773 ft<sup>3</sup>  
 dim. L 61 x W 143.5 x H 2.5 cm  
 L 24 x W 56.5 x H 1 in

#### BOX 2

gross w. 2.46 kg / 5.41 lbs  
 vol. 0.040 m<sup>3</sup> / 1.399 ft<sup>3</sup>  
 dim. L 41 x W 42 x H 23 cm  
 L 16.1 x W 16.5 x H 9.1 in



white



grey chrome



red

NEW YORK 33

NEW YORK 45

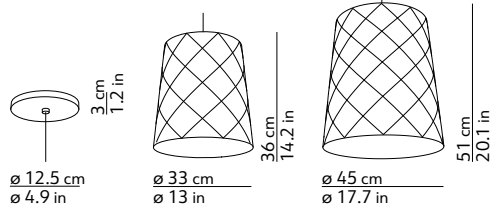

## SUSPENSION

\* not included

# OPYO SUSPENSION

CRISTINA CELESTINO, 2019



CODE	COLOUR	PRICE VAT excl.
K350356B	white	<b>358 €</b>
K350356C	coral	
K350356O	brass	

## LIGHT SOURCE\*

1x70W max - E27 (E26)

## FEEDING

220-240 / 120 V

## DIMMABLE

yes

## LIGHT DIRECTION



## CERTIFICATIONS

⊕ IP20 CE ENEC

## MATERIALS

glass + metal

## CABLE LENGTH

180 cm / 70.9 in

## CANOPY

white RAL 9010

## PACKAGING

### BOX 1

gross w. 2.00 kg / 4.40 lbs  
 vol. 0.027 m<sup>3</sup> / 0.968 ft<sup>3</sup>  
 dim. L 29.5 x W 29.5 x H 31.5 cm  
 L 11.6 x W 11.6 x H 12.4 in

### BOX 2

gross w. 1.5 kg / 3.3 lbs  
 vol. 0.003 m<sup>3</sup> / 0.089 ft<sup>3</sup>  
 dim. L 22.5 x W 22.5 x H 5 cm  
 L 8.9 x W 8.9 x H 2 in



white RAL9010

coral RAL3012

brass 219

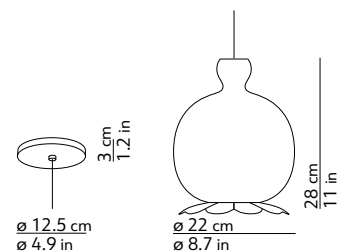

# PEACOCK

NOÉ DUCHAUFOUR LAWRENCE, 2013



CODE	COLOUR	PRICE VAT excl.
080250T	acid-etched brass	6100 €

**LIGHT SOURCE\***

board LED 12x4.5W  
2700 K - 6000 lm - CRI>90

**FEEDING**

110-240 V

**DIMMABLE**

1-10V (push or DALI on request)

**LIGHT DIRECTION**



**CERTIFICATIONS**

⊕ IP20 CE ENEC

**MATERIALS**

steel + glass

**CABLE LENGTH**

180 cm / 70.9 in

**CANOPY**

acid-etched brass

**PACKAGING**

**BOX 1**

gross w. 30.4 kg / 66.88 lbs  
vol. 0.673 m<sup>3</sup> / 23.768 ft<sup>3</sup>  
dim. L 86 x W 86 x H 91 cm  
L 33.9 x W 33.9 x H 35.8 in



acid-etched brass

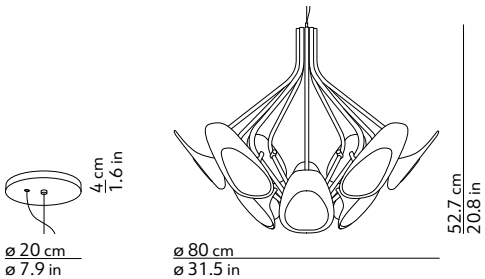

# POISE CEILING

ROBERT DABI, 2022



CODE	COLOUR	PRICE VAT excl.
505426N	black	460 €

### LIGHT SOURCE\*

strip LED 1x28W  
2700 K - 3600 lm - CRI>90

### FEEDING

220-240 / 120 V

### DIMMER

phase cut

### LIGHT DIRECTION



### CERTIFICATIONS

⊕ IP20 CE ENEC

### MATERIALS

metal

### PACKAGING

#### BOX 1

gross w. 3.8 kg / 8.4 lbs  
vol. 0.031 m<sup>3</sup> / 1.059 ft<sup>3</sup>  
dim. L 60 x W 60 x H 8.5 cm  
L 23.6 x W 23.6 x H 3.4 in



black RAL9005

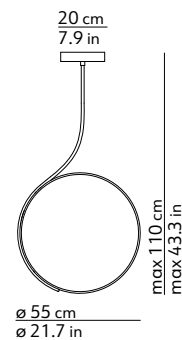

# SPILLO CEILING

CONSTANTIN WORTMANN, 2010



CODE	COLOUR	PRICE VAT excl.
<b>SPILLO CEILING</b> 232135EU	white	<b>356 €</b>
<b>SPILLO OUTDOOR CEILING</b> 232135IPEU	white	<b>319 €</b>

## LIGHT SOURCE\*

1x21W max - E27 (E26)  
 Ø 5cm max

## FEEDING

220-240 / 120 V

## DIMMABLE

yes

## LIGHT DIRECTION



## CERTIFICATIONS

### SPILLO CEILING

⊕ IP20 CE ENEC

### SPILLO OUTDOOR CEILING

⊠ IP65 CE ENEC

## MATERIALS

polyethylene + metal

## CABLE LENGTH

180 cm / 70.9 in

## CANOPY

### SPILLO CEILING

white

### SPILLO OUTDOOR CEILING

IP 65 connector

## PACKAGING

### BOX 1

gross w. 2.44 kg / 5.37 lbs  
 vol. 0.047 m<sup>3</sup> / 1.647 ft<sup>3</sup>  
 dim. L 26 x W 26 x H 69 cm  
 L 10.2 x W 10.2 x H 27.2 in

## SPILLO CEILING SPILLO OUTDOOR CEILING



white



white + black cable

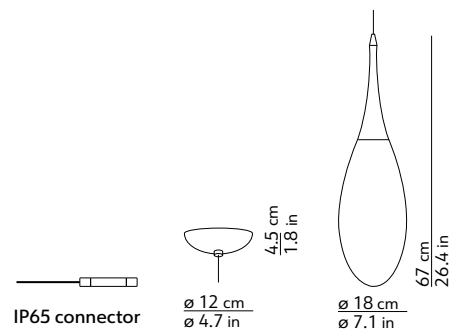

## SUSPENSION

\* not included

# TOOT SUSPENSION

KARIM RASHID, 2017



CODE	COLOUR	PRICE VAT excl.
K401335	mixed colours	1350 €

## LIGHT SOURCE\*

board LED 3x5W  
2700 K - 1500 lm - CRI>90

## FEEDING

100-240 V

## DIMMABLE

1-10V or push

## LIGHT DIRECTION



## CERTIFICATIONS

⊕ IP20 CE ENEC

## MATERIALS

plexiglas + metal

## CABLE LENGTH

180 cm / 70.9 in

## CANOPY

black RAL9005

## PACKAGING

### BOX 1

gross w. 3.2 kg / 7.04 lbs  
vol. 0.033 m<sup>3</sup> / 1.171 ft<sup>3</sup>  
dim. L 27 x W 27 x H 45.5 cm  
L 10.7 x W 10.7 x H 17.9 in

### BOX 2

gross w. 3.52 kg / 7.74 lbs  
vol. 0.033 m<sup>3</sup> / 1.171 ft<sup>3</sup>  
dim. L 27 x W 27 x H 45.5 cm  
L 10.7 x W 10.7 x H 17.9 in



mixed colours

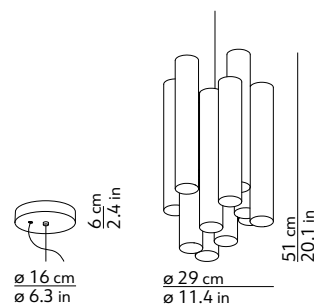

# TRIPOD CEILING

CHRISTOPHE PILLET, 2002



CODE	COLOUR	PRICE VAT excl.
223945BIEU	white	<b>605 €</b>
223945ECEU	ecrù	
223945MOEU	moka	

## LIGHT SOURCE\*

3x70W max - E27 (E26)

## FEEDING

220-240 / 120 V

## DIMMABLE

yes

## LIGHT DIRECTION



## CERTIFICATIONS

⊕ IP20 CE ENEC

## MATERIALS

metal + fabric

## CABLE LENGTH

180 cm / 70.9 in

## CANOPY

white

## PACKAGING

### BOX 1

gross w. 5.32 kg / 11.7 lbs  
 vol. 0.119 m<sup>3</sup> / 4.195 ft<sup>3</sup>  
 dim. L 60 x W 60 x H 33 cm  
 L 23.6 x W 23.6 x H 13 in



white

ecrù

moka

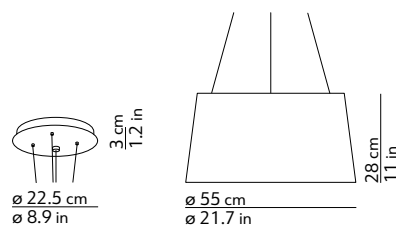



# VICEVERSA

NOÉ DUCHAUFOR LAWRENCE, 2019



CODE	COLOUR	PRICE VAT excl.
K370280GA	amber	<b>980 €</b>
K370280GF	smokey grey	

**LIGHT SOURCE\***

board LED 1x6.5W  
2700 K - 800 lm - CRI>90

**FEEDING**

110-240 V

**DIMMABLE**

1-10V

**LIGHT DIRECTION**



**CERTIFICATIONS**

⊕ IP20\*\* CE ENEC

**MATERIALS**

glass + metal

**CABLE LENGTH**

180 cm / 70.9 in

**CANOPY**

grey RAL7016

\*\* canopy IP20

structure built in compliance with IP54 specifications

**PACKAGING**

**BOX 1**

gross w. 2.2 kg / 4.84 lbs  
vol. 0.029 m<sup>3</sup> / 1.024 ft<sup>3</sup>  
dim. L 28 x W 28 x H 37 cm  
L 11 x W 11 x H 14.6 in

**BOX 2**

gross w. 4 kg / 8.8 lbs  
vol. 0.025 m<sup>3</sup> / 0.880 ft<sup>3</sup>  
dim. L 82 x W 32 x H 9.5 cm  
L 32.3 x W 12.6 x H 3.7 in



amber



smokey grey

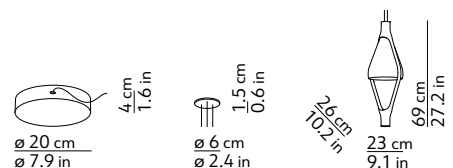

# VICEVERSA 2

NOÉ DUCHAUFOR LAWRENCE, 2019



CODE	COLOUR	PRICE VAT excl.
K370281GA	amber	<b>1760 €</b>
K370281GF	smokey grey	

**LIGHT SOURCE\***

board LED 2x6.5W  
2700 K - 1600 lm - CRI>90

**FEEDING**

110-240 V

**DIMMABLE**

1-10V

**LIGHT DIRECTION**



**CERTIFICATIONS**

⊕ IP20\*\* CE ENEC

**MATERIALS**

glass + metal

**CABLE LENGTH**

180 cm / 70.9 in

**CANOPY**

grey RAL7016

\*\* canopy IP20

structure built in compliance with IP54 specifications

**PACKAGING**

BOX 1 - BOX 2

gross w. 2.2 kg / 4.84 lbs  
vol. 0.029 m<sup>3</sup> / 1.024 ft<sup>3</sup>  
dim. L 28 x W 28 x H 37 cm  
L 11 x W 11 x H 14.6 in

BOX 3 - BOX 4

gross w. 4 kg / 8.8 lbs  
vol. 0.025 m<sup>3</sup> / 0.880 ft<sup>3</sup>  
dim. L 82 x W 32 x H 9.5 cm  
L 32.3 x W 16.6 x H 3.7 in



amber



smokey grey

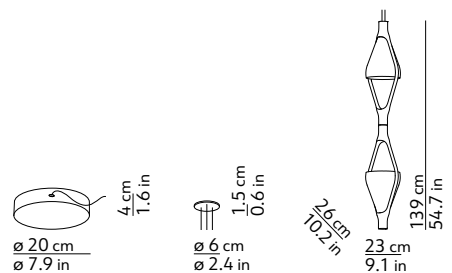

# YUMA

DAVID POMPA, 2017



CODE	COLOUR	PRICE VAT excl.
370310EU	brass	<b>310 €</b>

#### LIGHT SOURCE\*

1x20W max - E27 (E26)

#### FEEDING

220-240 / 120 V

#### DIMMABLE

yes

#### LIGHT DIRECTION



#### CERTIFICATIONS

⊕ IP20 CE ENEC

#### MATERIALS

glass + metal

#### CABLE LENGTH

180 cm / 70.9 in

#### CANOPY

brass 307

#### PACKAGING

##### BOX 1

gross w. 1.78 kg / 3.92 lbs

vol. 0.012 m<sup>3</sup> / 0.426 ft<sup>3</sup>

dim. L 30.5 x W 25.5 x H 15.5 cm

L 12 x W 10 x H 6.1 in



brass 307

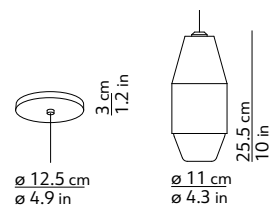

# ATOMIUM WALL

HOPF&WORTMANN - BÜRO FÜR FORM, 2006



CODE	COLOUR	PRICE VAT excl.
011891BIEU	white	319 €

### LIGHT SOURCE\*

3x40W max - E14 (E12)

### FEEDING

220-240 / 120 V

### DIMMABLE

yes

### LIGHT DIRECTION



### CERTIFICATIONS

⊕ IP20 CE ENEC

### MATERIALS

polyethylene

### PACKAGING

#### BOX 1

gross w. 5.16 kg / 11.35 lbs

vol. 0.099 m<sup>3</sup> / 3.493 ft<sup>3</sup>

dim. L 59.5 x W 54.5 x H 30.5 cm

L 23.4 x W 21.5 x H 12 in



white

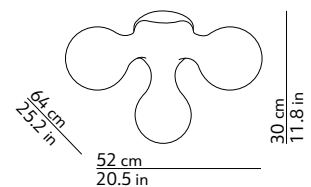

# AZOU 3

CHRIS BASIAS, 2019



CODE	COLOUR	PRICE VAT excl.
K3454113MB	white marble	<b>610 €</b>
K3454113MN	black marble	
K3454113MO	green onyx	<b>990 €</b>
<b>OPTIONAL</b>		
345-PLUGEU / GB	driver + dimmer + plug	<b>100 €</b>
500515N**	black canopy	<b>115 €</b>
ALI-0003	driver dim. 1-10V or push	<b>105 €</b>

\*\*driver not included

### LIGHT SOURCE\*

board LED 3x4.2W  
2700 K - 1350 lm - CRI>90

### FEEDING

220-240 / 120 V

### DIMMABLE

yes

### LIGHT DIRECTION



### CERTIFICATIONS

⊕ IP20 CE ENEC

### DRIVER + DIMMER + PLUG

⊠ IP20 CE ENEC

### MATERIALS

metal + marble or onyx

### PACKAGING

#### BOX 1

gross w. 1.7 kg / 3.74 lbs  
vol. 0.007 m<sup>3</sup> / 0.250 ft<sup>3</sup>  
dim. L 24.5 x W 17.5 x H 16.5 cm  
L 9.7 x W 6.9 x H 6.5 in

#### BOX 2

gross w. 1.95 kg / 4.29 lbs  
vol. 0.008 m<sup>3</sup> / 0.294 ft<sup>3</sup>  
dim. L 36 x W 21 x H 11 cm  
L 14.2 x W 8.3 x H 4.3 in



white marble

black marble

green onyx

### CANOPY

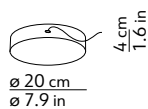

### DRIVER+DIMMER+PLUG

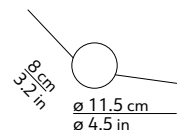

# AZOU 5

CHRIS BASIAS, 2019

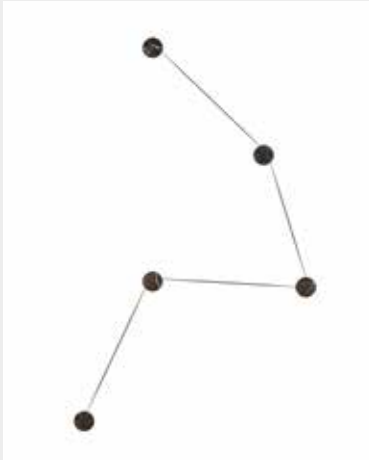

CODE	COLOUR	PRICE VAT excl.
K3454115MB	white marble	<b>905 €</b>
K3454115MN	black marble	
K3454115MO	green onyx	<b>1495 €</b>
<b>OPTIONAL</b>		
345-PLUGEU / GB	driver + dimmer + plug	<b>100 €</b>
500515N**	black canopy	<b>115 €</b>
ALI-0003	driver dim. 1-10V or push	<b>105 €</b>

\*\*driver not included

### LIGHT SOURCE\*

board LED 5x4.2W  
2700 K - 2250 lm - CRI>90

### FEEDING

220-240 / 120 V

### DIMMABLE

yes

### LIGHT DIRECTION



### CERTIFICATIONS

⊕ IP20 CE ENEC

### DRIVER + DIMMER + PLUG

⊞ IP20 CE ENEC

### MATERIALS

metal + marble or onyx

### PACKAGING

#### BOX 1

gross w. 2.9 kg / 6.38 lbs  
vol. 0.014 m<sup>3</sup> / 0.489 ft<sup>3</sup>  
dim. L 48 x W 17.5 x H 16.5 cm  
L 18.9 x W 6.9 x H 6.5 in

#### BOX 2

gross w. 2.41 kg / 5.3 lbs  
vol. 0.008 m<sup>3</sup> / 0.294 ft<sup>3</sup>  
dim. L 36 x W 21 x H 11 cm  
L 14.2 x W 8.3 x H 4.3 in



white marble

black marble

green onyx

### CANOPY

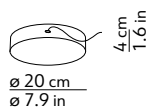

### DRIVER+DIMMER+PLUG

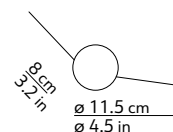

# AZOU 7

CHRIS BASIAS, 2019

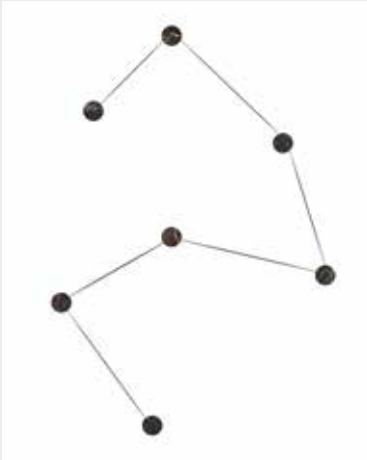

CODE	COLOUR	PRICE VAT excl.
K3454117MB	white marble	<b>1215 €</b>
K3454117MN	black marble	
K3454117MO	green onyx	<b>2050 €</b>
<b>OPTIONAL</b>		
345-PLUGEU / GB	driver + dimmer + plug	<b>100 €</b>
500515N**	black canopy	<b>115 €</b>
ALI-0003	driver dim. 1-10V or push	<b>105 €</b>

\*\*driver not included

### LIGHT SOURCE\*

board LED 7x4.2W  
2700 K - 3150 lm - CRI>90

### FEEDING

220-240 / 120 V

### DIMMABLE

yes

### LIGHT DIRECTION



### CERTIFICATIONS

⊕ IP20 CE ENEC

### DRIVER + DIMMER + PLUG

⊞ IP20 CE ENEC

### MATERIALS

metal + marble or onyx

### PACKAGING

#### BOX 1

gross w. 3.85 kg / 8.47 lbs  
vol. 0.014 m<sup>3</sup> / 0.489 ft<sup>3</sup>  
dim. L 48 x W 17.5 x H 16.5 cm  
L 18.9 x W 6.9 x H 6.5 in

#### BOX 2

gross w. 2.9 kg / 6.38 lbs  
vol. 0.008 m<sup>3</sup> / 0.294 ft<sup>3</sup>  
dim. L 36 x W 21 x H 11 cm  
L 14.2 x W 8.3 x H 4.3 in



white marble

black marble

green onyx

### CANOPY

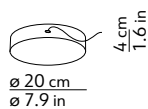

### DRIVER+DIMMER+PLUG

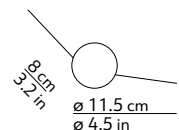

# EVITA WALL

AQUILIALBERG, 2011



CODE	COLOUR	PRICE VAT excl.
155065B	warm white	<b>335 €</b>
155065N	black	
155065T	dove-grey	
155065R	red	

## LIGHT SOURCE\*

board LED 1x20W  
2700 K - 2000 lm - CRI>80

## FEEDING

220-240 / 120 V

## DIMMABLE

phase cut

## LIGHT DIRECTION



## CERTIFICATIONS

⊕ IP20 CE ENEC

## MATERIALS

polyethylene + technopolymers

## PACKAGING

### BOX 1

gross w. 1.46 kg / 3.21 lbs  
vol. 0.016 m<sup>3</sup> / 0.570 ft<sup>3</sup>  
dim. L 45 x W 17.5 x H 20.5 cm  
L 17.7 x W 6.9 x H 8.1 in



warm white RAL1013



black RAL9005



dove-grey RAL7006



red RAL3003

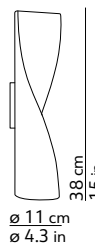



# FRAME

BENJAMIN HUBERT, 2011



CODE	COLOUR	PRICE VAT excl.
145050B	white	281 €
145050C	chrome	329 €

**LIGHT SOURCE\***

1x150W max - R7s - L 78 mm

**FEEDING**

220-240 / 120 V

**DIMMABLE**

yes

**LIGHT DIRECTION**



**CERTIFICATIONS**

⊕ IP20 CE ENEC

**MATERIALS**

aluminium

**PACKAGING**

BOX 1

gross w. 1.42 kg / 3.12 lbs  
 vol. 0.007 m<sup>3</sup> / 0.257 ft<sup>3</sup>  
 dim. L 40.5 x W 36 x H5 cm  
 L 16 x W 14.2 x H 2 in



white RAL9010



chrome

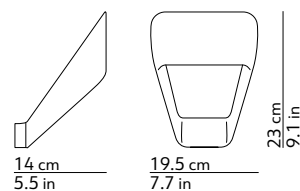

# NAMI WALL

ALBERTO SAGGIA & VALERIO SOMMELLA, 2020



CODE	COLOUR	PRICE VAT excl.
K340406N	black	<b>281 €</b>
K340406O	brass	

### LIGHT SOURCE\*

board LED 1x12W  
2700 K - 1750 lm - CRI>90

### FEEDING

220-240 / 120 V

### DIMMABLE

phase cut

### LIGHT DIRECTION



### CERTIFICATIONS

⊕ IP20 CE ENEC

### MATERIALS

glass + aluminium

### PACKAGING

#### BOX 1

gross w. 0.93kg / 2.05 lbs  
vol. 0.011 m<sup>3</sup> / 0.371 ft<sup>3</sup>  
dim. L 35 x W 24 x H 12.5 cm  
L 13.8 x W 9.5 x H 4.9 in

#### BOX 2

gross w. 1.07 kg / 2.35 lbs  
vol. 0.003 m<sup>3</sup> / 0.096 ft<sup>3</sup>  
dim. L 20 x W 13 x H 10.5 cm  
L 7.9 x W 5.1 x H 4.1 in



black RAL9005



brass 111

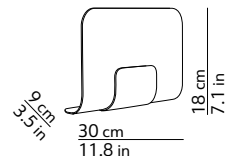

# NEW YORK WALL

PETER JAMIESON, 2015



CODE	COLOUR	PRICE VAT excl.
K090262WB	white	<b>265 €</b>
K090262WC	grey chrome	
K090262WR	red	

## LIGHT SOURCE\*

1x30W max - E27 (E26)

## FEEDING

220-240 / 120 V

## DIMMABLE

yes

## LIGHT DIRECTION



## CERTIFICATIONS

⊕ IP20 CE ENEC

## MATERIALS

technopolymer + methacrylate

## PACKAGING

### BOX 1

gross w. 0.5 kg / 1.1 lbs  
 vol. 0.003 m<sup>3</sup> / 0.121 ft<sup>3</sup>  
 dim. L 28 x W 61 x H 2 cm  
 L 11 x W 24 x H 0.8 in

### BOX 2

gross w. 0.76 kg / 1.67 lbs  
 vol. 0.008 m<sup>3</sup> / 0.272 ft<sup>3</sup>  
 dim. L 29.5 x W 26 x H 10 cm  
 L 11.6 x W 10.2 x H 3.9 in



white

grey chrome

red

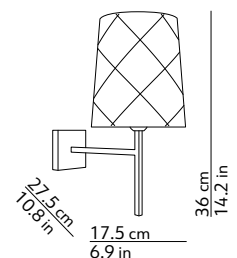

# PASTILLA

PATRICIA URQUIOLA, 2000



CODE	COLOUR	PRICE VAT excl.
218970BIAEU	white	<b>221 €</b>
218970BREU	bronze	

**LIGHT SOURCE\***  
2x42W max - E14 (E12)

**FEEDING**  
220-240 / 120 V

**DIMMABLE**  
yes

**LIGHT DIRECTION**



**CERTIFICATIONS**  
⊕ IP20 CE ENEC

**MATERIALS**  
glass + metal

**PACKAGING**  
**BOX 1**  
gross w. 2.06 kg / 4.53 lbs  
vol. 0.011 m<sup>3</sup> / 0.401 ft<sup>3</sup>  
dim. L 21 x W 19.5 x H 28 cm  
L 8.3 x W 7.7 x H 11 in



white RAL9016

bronze

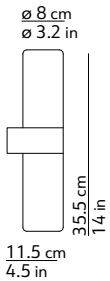

WALL

\* not included

# PIXEL

BAKERY GROUP, 2009



CODE	COLOUR	PRICE VAT excl.
044128BIEU	white	215 €

### LIGHT SOURCE\*

3x12W max - E14 (E12)

### FEEDING

220-240 / 120 V

### DIMMABLE

yes

### LIGHT DIRECTION



### CERTIFICATIONS

⊕ IP20 CE ENEC

### MATERIALS

polyethylene + metal

### PACKAGING

#### BOX 1

gross w. 2.1 kg / 4.62 lbs  
 vol. 0.035 m<sup>3</sup> / 1.221 ft<sup>3</sup>  
 dim. L 52.5 x W 42.5 x H 15.5 cm  
 L 20.7 x W 16.7 x H 6.1 in



white

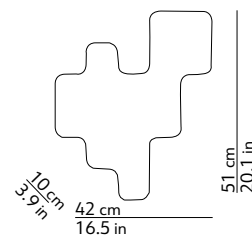

# SHAKTI WALL FIX 80

MARZIO RUSCONI CLERICI, 2002



CODE	COLOUR	PRICE VAT excl.
035341BIEU	white	248 €

## LIGHT SOURCE\*

1x60W max - E27 (E26)

## FEEDING

220-240 / 120 V

## DIMMABLE

yes

## LIGHT DIRECTION



## CERTIFICATIONS

⊕ IP20 CE ENEC

## MATERIALS

plexiglas

## PACKAGING

### BOX 1

gross w. 1.2 kg / 2.64 lbs  
 vol. 0.012 m<sup>3</sup> / 0.417 ft<sup>3</sup>  
 dim. L 82 x W 12 x H 12 cm  
 L 32.3 x W 4.7 x H 4.7 in



white

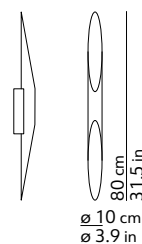

# TUA

BEHURT, 2014



CODE	COLOUR	PRICE VAT excl.
100266SNNL	black tin	<b>373 €</b>

#### LIGHT SOURCE\*

1x100W max - R7s - L 78 mm

#### FEEDING

220-240 / 120 V

#### DIMMABLE

yes

#### LIGHT DIRECTION



#### CERTIFICATIONS

⊕ IP20 CE ENEC

#### MATERIALS

glass + metal

#### PACKAGING

##### BOX 1

gross w. 1.26 kg / 2.77 lbs  
 vol. 0.012 m<sup>3</sup> / 0.419 ft<sup>3</sup>  
 dim. L 22 x W 22 x H 24.5 cm  
 L 8.7 x W 8.7 x H 9.7 in



black tin

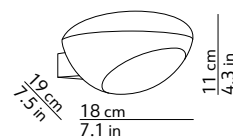

## ACCESSORIES

ACCESSORIES	CODE	COLOUR	PRICE VAT excl.
<b>2 HOLES CANOPY</b> 	500521CR	chrome	<b>65 €</b>
	500521N	black	
	500521O	brass 307	
	500521B	white	
<b>DECENTRALIZER</b> 	500518CR	chrome	<b>26 €</b>
	500518N	black	
	500518O	brass 307	
	500518B	white	
<b>DECENTRALIZER HOOK</b> 	500519N	black	<b>15 €</b>
	500519B	white	
<b>WIRE GRIPLOCK</b> 	500520CR	chrome	<b>15 €</b>
	500520N	black	
	500520B	white	



**GRAPHIC PROJECT**

VZNstudio

Printed in Italy

Arti Grafiche Meroni, May 2022

kdln is a registered trademark

Copyright © 2022 Kdln Srl

All Rights Reserved.

Reproduction in whole or in part of texts and images  
without express written permission is prohibited.



**Kdln Srl Viale L. da Vinci, 27 7**  
20090 Trezzano sul Naviglio, Milano  
T. +39 0236538950 [info@kdln.it](mailto:info@kdln.it)

**Registered office**  
Viale F. Crispi, 5/A 20121 Milano  
IT11792050152

[kdln.it](http://kdln.it)

