

ARCH

ITECT

URAL





martinelli luce



ARCHITECTURAL



ARCHITECTURAL

Martinelli Luce è un'azienda conosciuta nel campo del design per la sua produzione di lampade, alcune diventate delle icone del design non solo italiano come Cobra, Pipistrello e Profiterolle, firmate rispettivamente da Elio Martinelli, Gae Aulenti, Sergio Asti. Molte altre lampade sono state disegnate dagli anni '60 ad oggi sia da altri noti architetti sia, le più recenti, da giovani designer che sono andate ad ampliare la collezione raccolta nel catalogo "Lampade" raccogliendo molte segnalazioni e premi, come il Compasso d'Oro con la lampada Elica di Brian Sironi.

In tutti questi anni hanno preso forma moltissime idee che hanno portato alla produzione non solo di lampade per interni, ma anche lampade per l'outdoor e ad una linea di prodotti a carattere tecnico, dedicati ad illuminare ampi spazi architettonici, ma anche oggetti o particolari da valorizzare con una luce d'accento. Lampade progettate appositamente per le nuove sorgenti a Led e studiate per soddisfare le esigenze di illuminazione professionali, tipiche dei luoghi di lavoro come uffici, show-room, centri commerciali, musei, apparecchi spesso nati per un determinato progetto, ma poi inseriti nel presente catalogo "Architectural" che raccoglie i prodotti più tecnici.

Con la nostra esperienza, la ricerca, lo studio e oggi con i mezzi digitali disponibili in Azienda, cerchiamo di dare risposte personalizzate alle esigenze dei progettisti. Lo staff tecnico risponderà alle varie richieste anche attraverso la customizzazione dei nostri prodotti di serie o, se necessario, fornirà il supporto per la progettazione e la realizzazione di rendering, prototipi, prodotti o pezzi speciali, costruiti con cura artigianale, ma sempre con qualità industriale.

Ogni problematica illuminotecnica rappresenta per noi uno stimolo ed una sfida da vincere.

Martinelli Luce is a company known in the design field for its production of lamps, some of which have become icons of not only Italian design such as Cobra, Pipistrello and Profiterolle, signed respectively by Elio Martinelli, Gae Aulenti, Sergio Asti. Many other lamps have been designed from the '60s to the present both by other well-known architects and, the most recent, by young designers who have expanded the assortment collected in the "Lamps" catalogue, collecting many honours and awards, such as the Compasso d'Oro with the Brian Sironi Elica lamp.

In all these years many ideas have taken shape that have led to the production not only of indoor lamps, but also outdoor lamps and a line of products with a more technical character, dedicated to illuminate large architectural spaces, but also objects or details to be enhanced with an accent light.

Lamps designed specifically for the new LED sources and designed to meet the needs of professional lighting, typical of workplaces such as offices, showrooms, shopping malls, museums, devices often created for a specific project, but then included in this "Architectural" catalogue that collects the most technical products.

With our experience, research, study and today with the digital means available in the Company, we try to give personalized answers to the needs of designers. Our technical staff will respond to the various requests also through the customization of our series products or, if necessary, will provide support for the design and implementation of renderings, prototypes, products or special pieces, built with craftsmanship, but always with industrial quality.

Every lighting problem represents a stimulus and a challenge for us to overcome.











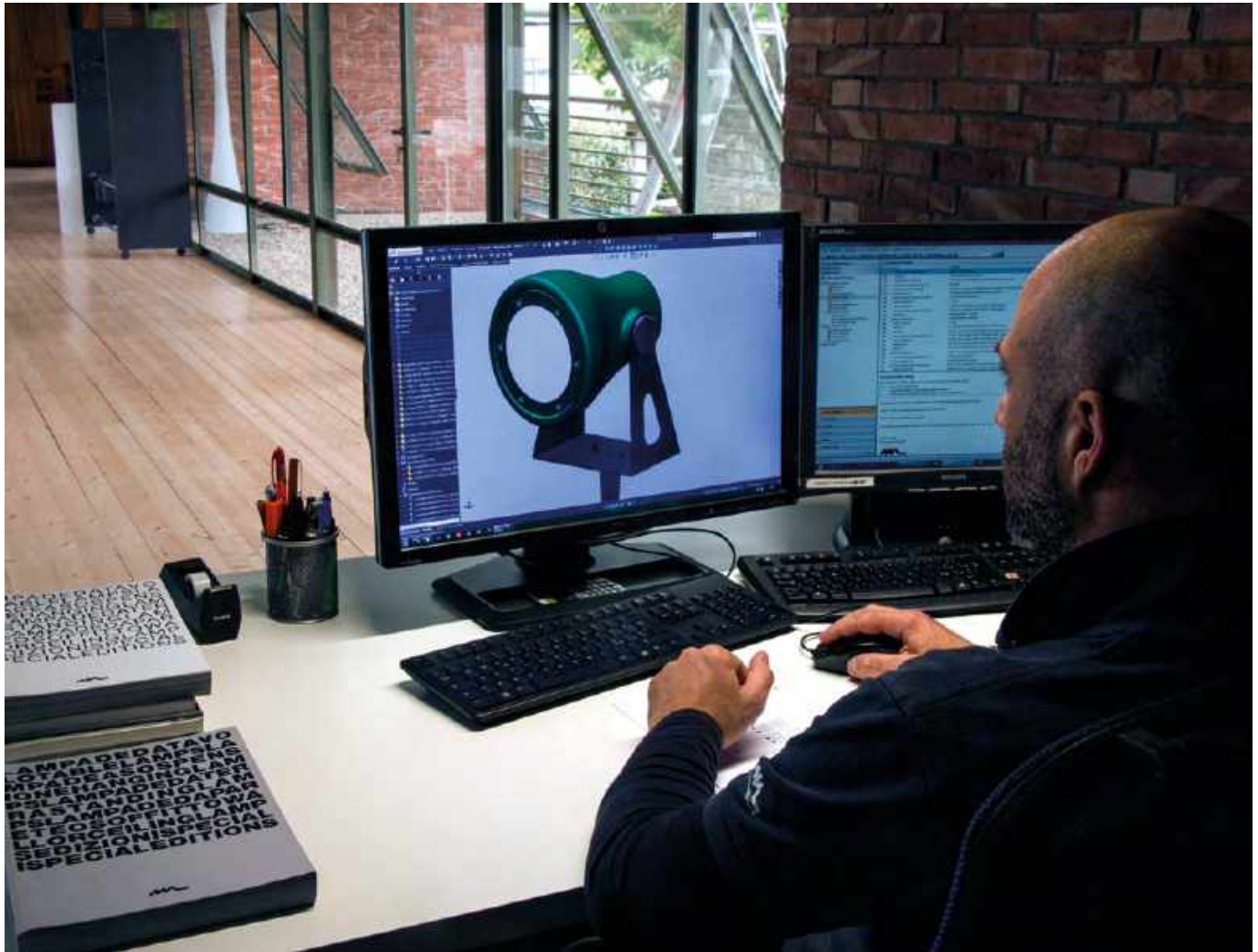

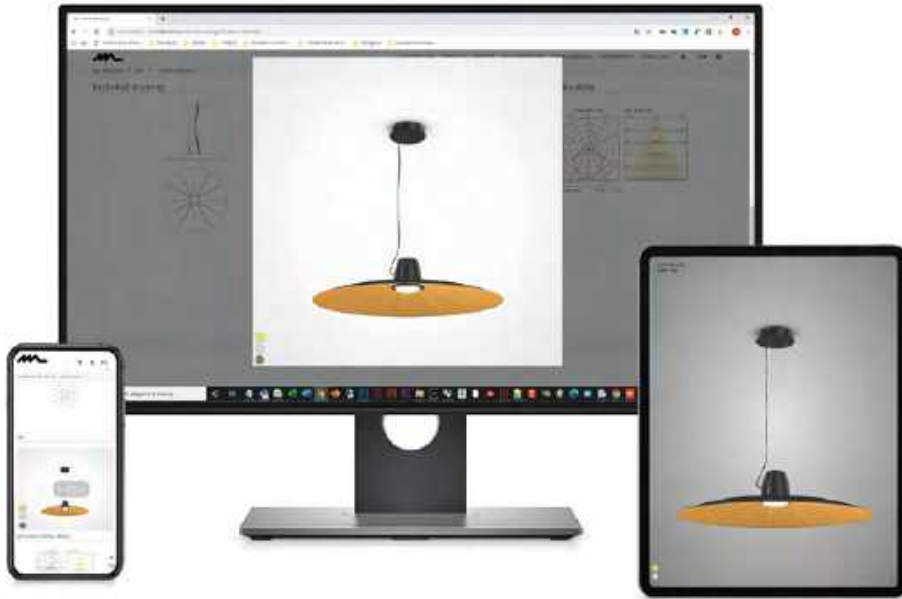

Servizi a supporto della progettazione illuminotecnica.
Digital services to support lighting design.

SayDuck

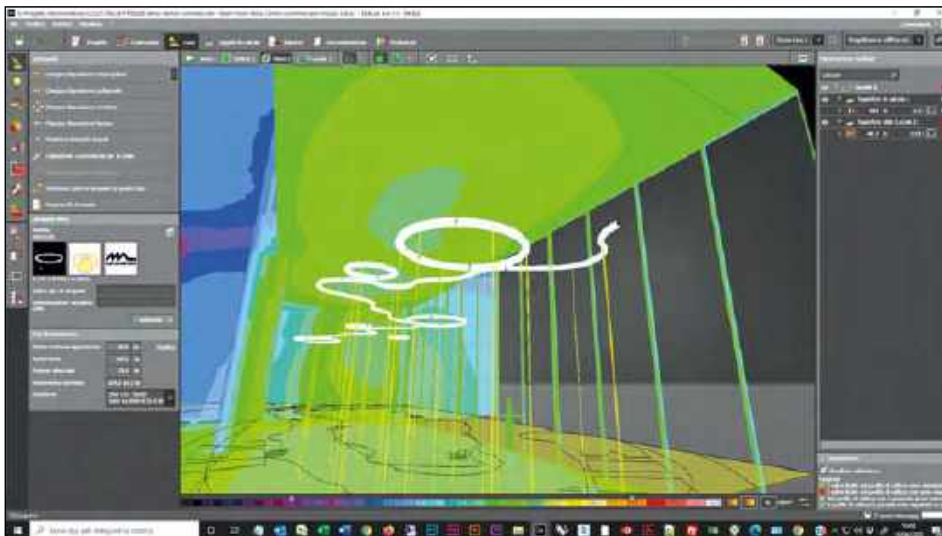

Dialux

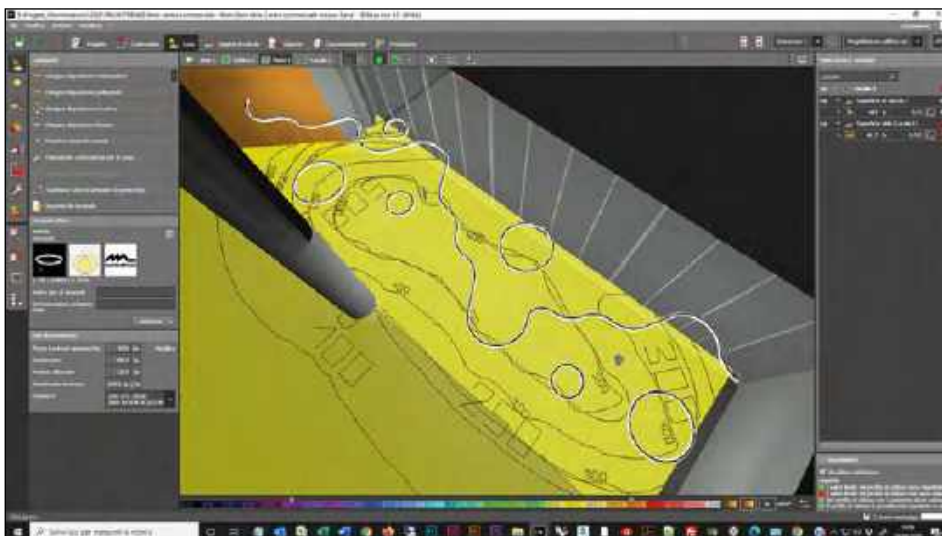

Martinelli Luce investe da anni nella tecnologia e in strumenti che possano rendere più facile la conoscenza dei propri prodotti e migliorare la risposta alle vostre necessità di illuminazione e di progettazione illuminotecnica, oggi anche attraverso le applicazioni di “realtà aumentata” e il 3D. Sul nostro sito www.martinelliluce.it, all'interno della scheda-prodotto, è possibile ruotare e zoomare l'apparecchio in modo da osservarlo da ogni angolazione, visualizzarlo in tutte le diverse possibili finiture e disporre delle relative dimensioni. Inoltre, potete scaricare i modelli 3D dei prodotti e utilizzarli nei vostri progetti di rendering o di progettazione. Attraverso la collaborazione con SayDuck, grazie alla realtà aumentata, è possibile contestualizzare, tramite la app scaricabile gratuitamente da Apple Store o Google Play, alcune delle nostre lampade all'interno degli spazi abitativi da voi progettati. Martinelli Luce inoltre, da diversi anni, è partner di Dial, un'azienda leader nella realizzazione di strumenti e software professionali (linea Dialux) utilizzati da architetti e progettisti di tutto il mondo per il calcolo, la progettazione e la visualizzazione illuminotecnica. Tramite il plug-in Dial scaricabile dal nostro sito è possibile, all'interno del programma Dialux, utilizzare i modelli 3D delle lampade presenti nel nostro catalogo, corredati da curva fotometrica, per realizzare calcoli illuminotecnici e rendering. I risultati possono essere trasferiti in programmi CAD tipo Revit, AutoCad, ArchiCAD, etc. Martinelli Luce metterà inoltre a disposizione degli utenti, un configuratore di prodotto che, in base allo specifico progetto, permetterà di creare una serie di famiglie di prodotto componibili in maniera semplice e grafica. La facilità d'uso del sistema renderà divertente crearsi il proprio prodotto in base alle personali esigenze di colore, dimensioni, forma, temperatura di colore e caratteristiche del fascio della sorgente luminosa, dimmerazione, così da ottenere alla fine della configurazione un documento pdf con tutti i dettagli del proprio progetto realizzato. Per gli utenti registrati il documento verrà corredato anche dei prezzi di listino e di ulteriori caratteristiche di dettaglio dei prodotti utilizzati.

Martinelli Luce has been investing for years in technology and tools that allow to better understand its products and improve the response to your lighting and design needs, today also through “augmented reality” and 3D images. On our website www.martinelliluce.it, inside the product technical datasheet, it is possible to rotate and zoom the device in order to observe it from every angle, visualize it in all the different possible finishes and extract its dimensions. In addition, you can download 3D models of the products and use them in your rendering or design projects. Thanks to augmented reality and our collaboration with SayDuck, it is possible to contextualize some of our lamps inside the living spaces you designed, through the free app available on the Apple Store or Google Play. Since many years Martinelli Luce is also a partner of Dial, a leading company in the creation of professional tools and software (Dialux line) used by architects and designers all over the world for lighting computations, designing and visualization. The Dial plug-in, available on our website let you use, within the Dialux program, the 3D models of all lamps in our catalogue, together with photometric curve, to perform lighting calculations and renderings. The results can be transferred into CAD programs such as Revit, AutoCad, ArchiCAD, etc. Martinelli Luce will also provide users with a configurator that, according to the specific project, will allow to create various families of modular products in a simple and graphical way. With this user-friendly system you will enjoy creating your own product according to your personal needs such as color, size, shape, dimming, color temperature and beam characteristics of the light source, in order to obtain at the end of the configuration a PDF document with all the details of your project. For registered users, the document will also include the price-list and additional details of the products used.

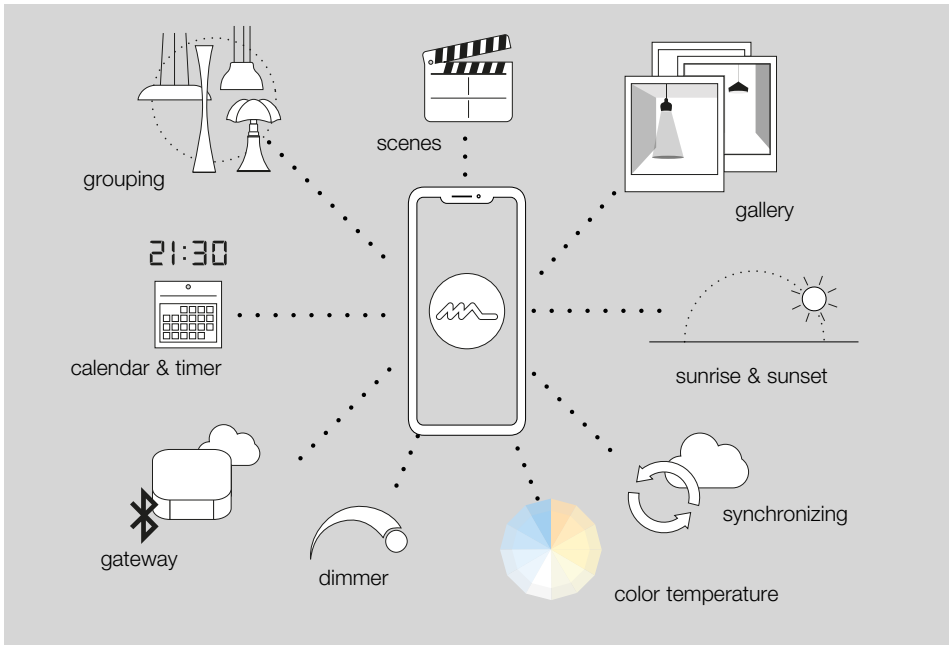

LIGHT YOU LIKE

“Light you like” è un progetto di Martinelli Luce che attraverso la tecnologia “Bluetooth” ti rende protagonista nello spazio del vivere quotidiano per dare vita a una nuova esperienza sensoriale e migliorare il tuo benessere.

Con questa innovazione tecnologica Martinelli Luce offre una luce modulabile grazie al sistema di controllo dell'intensità e per alcuni prodotti della temperatura del colore che ti permette di personalizzare lo spazio abitativo in base alle tue emozioni e sensazioni. Intervenire sull'illuminazione della tua abitazione diventa facile ed intuitivo, grazie all'utilizzo di app compatibili con i sistemi Apple e Android, le quali attraverso semplici controlli touch su smartphone e tablet permettono di regolare più dispositivi illuminanti e di adattare la luce alle tue esigenze.

Le lampade che utilizzano tale tecnologia sono evidenziati con il logo

LIGHT YOU LIKE



Con le app è possibile:

- Dimmerare le lampade tramite dispositivo bluetooth, iOS e Android Apps
- Regolare la temperatura della luce in maniera dinamica da 2500 a 6700K (per alcuni prodotti compatibili)
- Creare gruppi di lampade per la sincronizzazione (max 127)
- Creare scene: per accensioni temporali; per accensione/spegnimento gruppi di lampade
- Scattare una foto alla lampada e vederla nell'app per semplificare la selezione del prodotto.

“Light you like” is Martinelli Luce’s project which, through “Bluetooth” technology, makes you the protagonist in the space of your daily life to give life to a new sensorial experience and improve your well-being.

With this technological innovation, Martinelli Luce offers a modular light thanks to the system of control of the intensity and color temperature allowing you to customize your living space according to your emotions and sensations.

Working on the lighting of your home becomes easy and intuitive, thanks to the use of apps compatible with Apple and Android systems, which through simple touch controls on smartphones and tablets allow you to adjust multiple lighting devices and adapt the light to your needs .

The lamps that use this technology are highlighted with the logo

LIGHT YOU LIKE

With the apps you can:

- Dim the lamps via bluetooth device, iOS and Android Apps
- Adjust the light temperature dynamically from 2500 to 6700K (for some compatible products)
- Create groups of lamps for synchronization (max 127)
- Create scenes: for temporal lighting; for switching groups of lamps on/off
- Take a photo of the lamp and view it in the app to simplify product selection.

PREMI E RICONOSCIMENTI / AWARDS AND ACKNOLEGMENTS



reddot design award



menzione d'onore







INDICE / INDEX

INDOOR	25
OUTDOOR	461

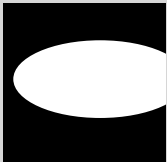
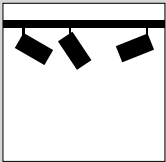
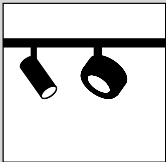

INDICE ALFABETICO PER FAMIGLIE / ALPHABETICAL INDEX BY PRODUCT FAMILY

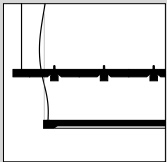
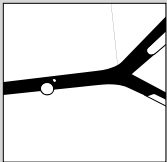
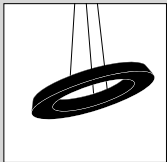
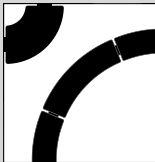
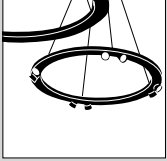
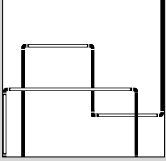
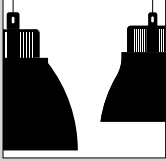
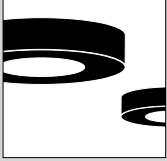
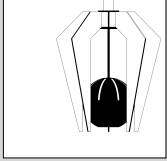
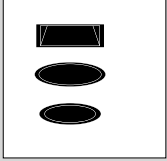
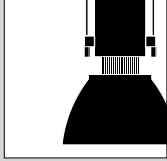
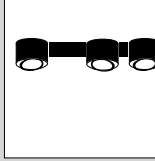
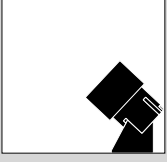
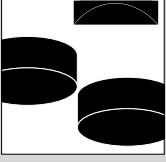
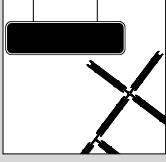
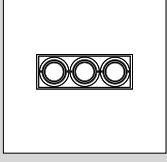
INDOOR

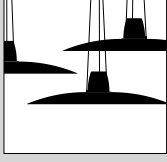
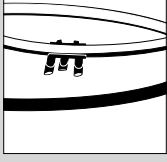
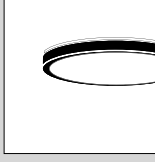
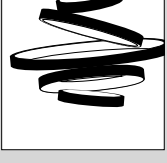
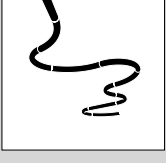
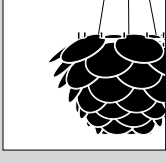
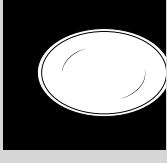
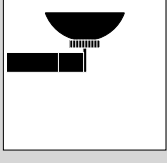
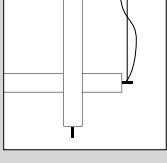
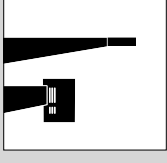
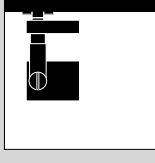
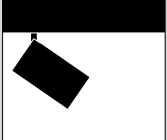
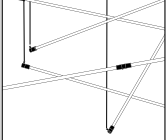
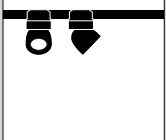
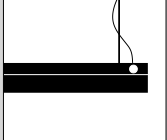
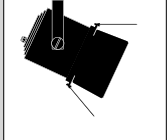
<p>BIG P. 438</p> 	<p>BINARI / TRACK P. 354</p> 	<p>BOMBO-CIP P. 310</p> 	<p>BRICK P. 418</p> 	<p>CALABRONE P. 218</p> 	<p>CALABRONET P. 238</p> 	<p>CIRCULAR POL P. 116</p> 	<p>CIRCULAR POL XXL P. 126</p> 
<p>CIRCULAR SLIM P. 072</p> 	<p>COLIBRI P. 180</p> 	<p>CONDOR P. 370</p> 	<p>CORONA P. 394</p> 	<p>CRAB P. 388</p> 	<p>DOT P. 452</p> 	<p>2003 P. 364</p> 	<p>EYE P. 426</p> 
<p>GRILLO P. 316</p> 	<p>HOLE-LIGHT P. 398</p> 	<p>HUSH P. 158</p> 	<p>INC P. 448</p> 	<p>KOKO P. 266</p> 	<p>LENT P. 150</p> 	<p>LOOP P. 026</p> 	<p>LUNA P. 084</p> 
<p>LUNAOP P. 054</p> 	<p>MAMBA P. 094</p> 	<p>NUVOLE Vagabonde P. 376</p> 	<p>OBLÒ P. 444</p> 	<p>OLYMPIC P. 412</p> 	<p>PISTILLO P. 142</p> 	<p>Q8 Q8-HP P. 402</p> 	<p>R11-R14-R19-S20 P. 324</p> 
<p>RICCIO P. 296</p> 	<p>SHANGHAI P. 248</p> 	<p>SISTEMA U P. 278</p> 	<p>SOUND P. 382</p> 	<p>SPOTTÒ P. 344</p> 			

INDOOR

SOSPENSIONI / SUSPENSIONS

CALABRONE
P. 230



CALABRONE
P. 232



CALABRONET
P. 246



CIRCULAR POL
P. 122



CIRCULAR POL XXL
P. 138



CIRCULAR SLIM
P. 080



COLIBRÌ
P. 202



COLIBRÌ
P. 204



COLIBRÌ
P. 208



COLIBRÌ
P. 212



CONDOR
P. 374



CRAB
P. 392



2003
P. 368



HUSH
P. 168



HUSH
P. 176



KOKO
P. 276



LENT
P. 156



LOOP circular
P. 040



LOOP square
P. 044



LOOP linear
P. 048



LUNA
P. 090



LUNAOP
P. 064



MAMBA
P. 108

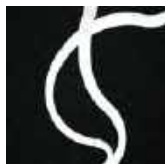

NUVOLE Vagabonde
P. 380



PISTILLO
P. 148



RICCIO
P. 304



SHANGHAI
P. 258



SISTEMA U
P. 288



SISTEMA U
P. 292



























SOUND
P. 386



INDICE ALFABETICO PER TIPOLOGIA / ALPHABETICAL INDEX BY PRODUCT TYPE

INDOOR

PARETE-SOFFITTO / WALL-CEILING

BRICK P. 422	CALABRONE P. 234	CIRCULAR POL P. 124	COLIBRI P. 206	COLIBRI P. 210	COLIBRI P. 214	COLIBRI P. 216	CORONA P. 396
							
EYE P. 434	GRILLO P. 322	HOLE-LIGHT P. 400	HUSH P. 172	HUSH P. 178	LUNA P. 092	LUNAOP P. 070	MAMBA P. 108
							
MAMBA P. 114	OLYMPIC P. 416	Q8 P. 408	Q8-HP P. 410	R11 P. 336	RICCIO P. 304	SHANGHAI P. 260	SISTEMA U P. 290
							

INDICE ALFABETICO PER TIPOLOGIA / ALPHABETICAL INDEX BY PRODUCT TYPE

INDOOR

TERRA / FLOOR

BRICK
P. 424

CALABRONE
P. 236

SPOTTÒ
P. 352



FARETTI PER BINARIO ELETTRIFICATO / SPOTLIGHTS FOR ELECTRIFIED TRACK

BOMBO
P. 314

CIP
P. 314

GRILLO
P. 322

MODULI
P. 360

R11
P. 334

R14
P. 340

R19
P. 332

S20
P. 342



SISTEMA U
P. 288

SPOTTÒ
P. 350



INCASSI / RECESSED

BIG
P. 442

DOT
P. 456

EYE
P. 436

INC
P. 450

OBLÒ
P. 446

RICCIO
P. 308



INDICE ALFABETICO PER FAMIGLIE / ALPHABETICAL INDEX BY PRODUCT FAMILY

OUTDOOR

BICONICA POL
P. 578



BOLETO
P. 484

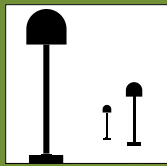

BOWL
P. 594

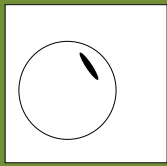

BRUCO
P. 472



CIULIFRULI
P. 548



CYBORG
P. 490



2250
P. 600



FROG
P. 462

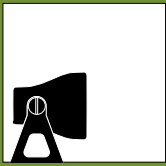

GLOUGLOU POL
P. 586

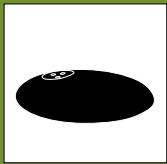

KIKI
P. 534

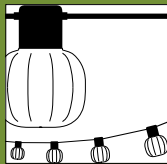

KOALA
P. 526

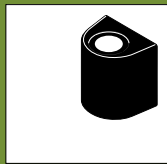

PONT
P. 496



PLAN
P. 530

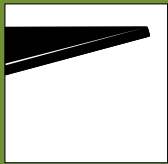

PISTILLO
P. 568

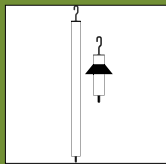

POLO
P. 512

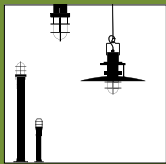

OUT
P. 502

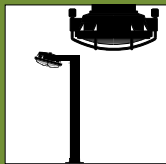

TRILLY
P. 560

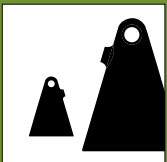



indoor

LOOP
LUNAOP
CIRCULAR SLIM
LUNA
MAMBA
CIRCULAR POL
CIRCULAR POL XXL
PISTILLO
LENT
HUSH
COLIBRÌ
CALABRONE
CALABRONET
SHANGHAI
KOKO
SISTEMA U
RICCIO
BOMBO
CIP
GRILLO
R19 / R11 / R14 / S20
SPOTTÒ
BINARI
2003
CONDOR
NUVOLE VAGABONDE
SOUND
CRAB
CORONA
HOLE-LIGHT
Q8 / Q8-HP
OLYMPIC
BRICK
EYE
BIG
OBLÒ
INC
DOT



LOOP



Un sottile profilo in estruso di alluminio calandrato definisce anelli di vari diametri e forme quadrangolari. Un sistema a luce diffusa e tecnologica per illuminare grandi ambienti che richiedono un'alta efficienza luminosa con una presenza leggera.

A slim structure in extruded calendered aluminium to define rings having different diameters and quadrangular shapes. A system with diffused and technological light for large environments that require high luminous efficiency through a lightweight object.

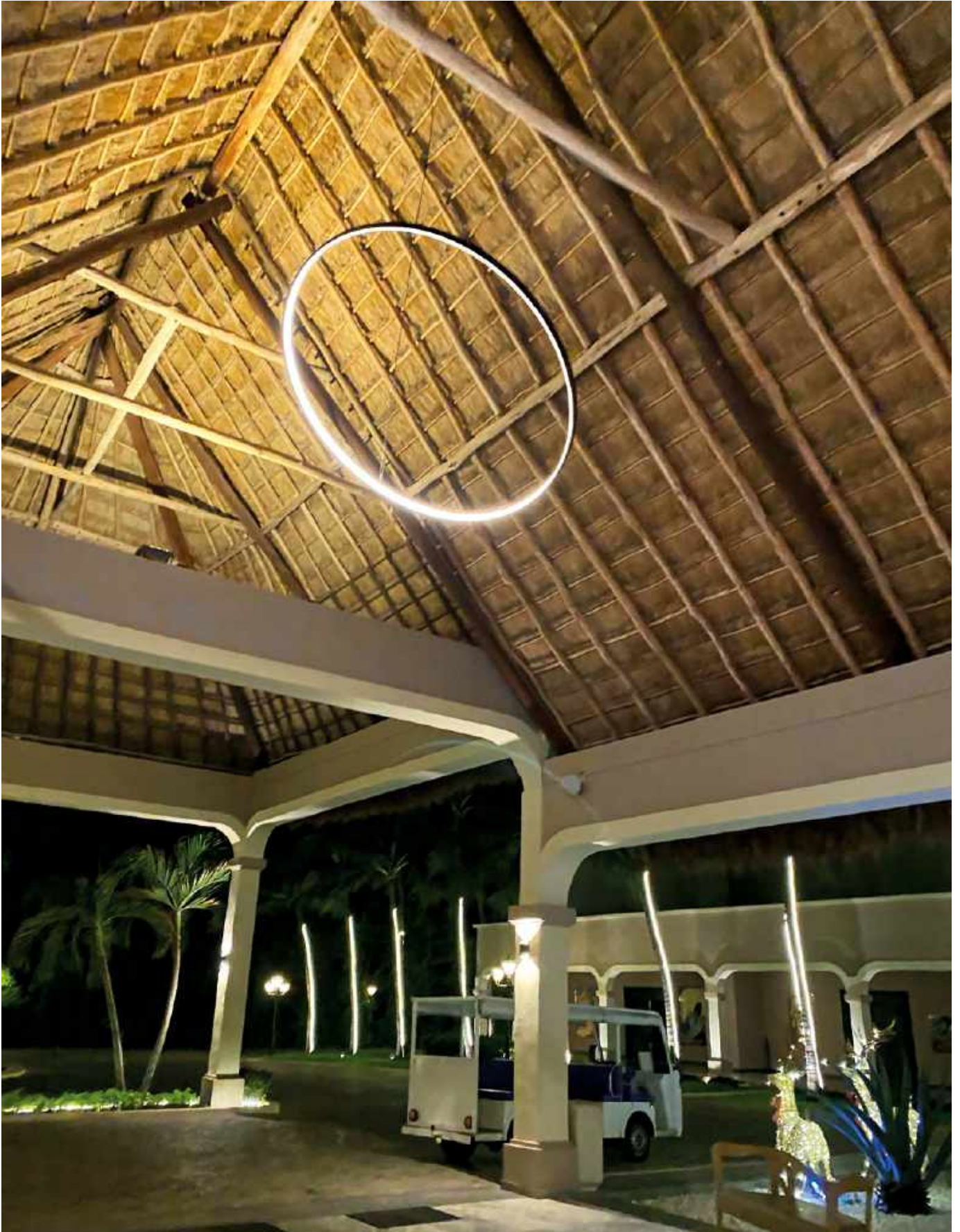

Hotel TRS, Yucatán, Messico

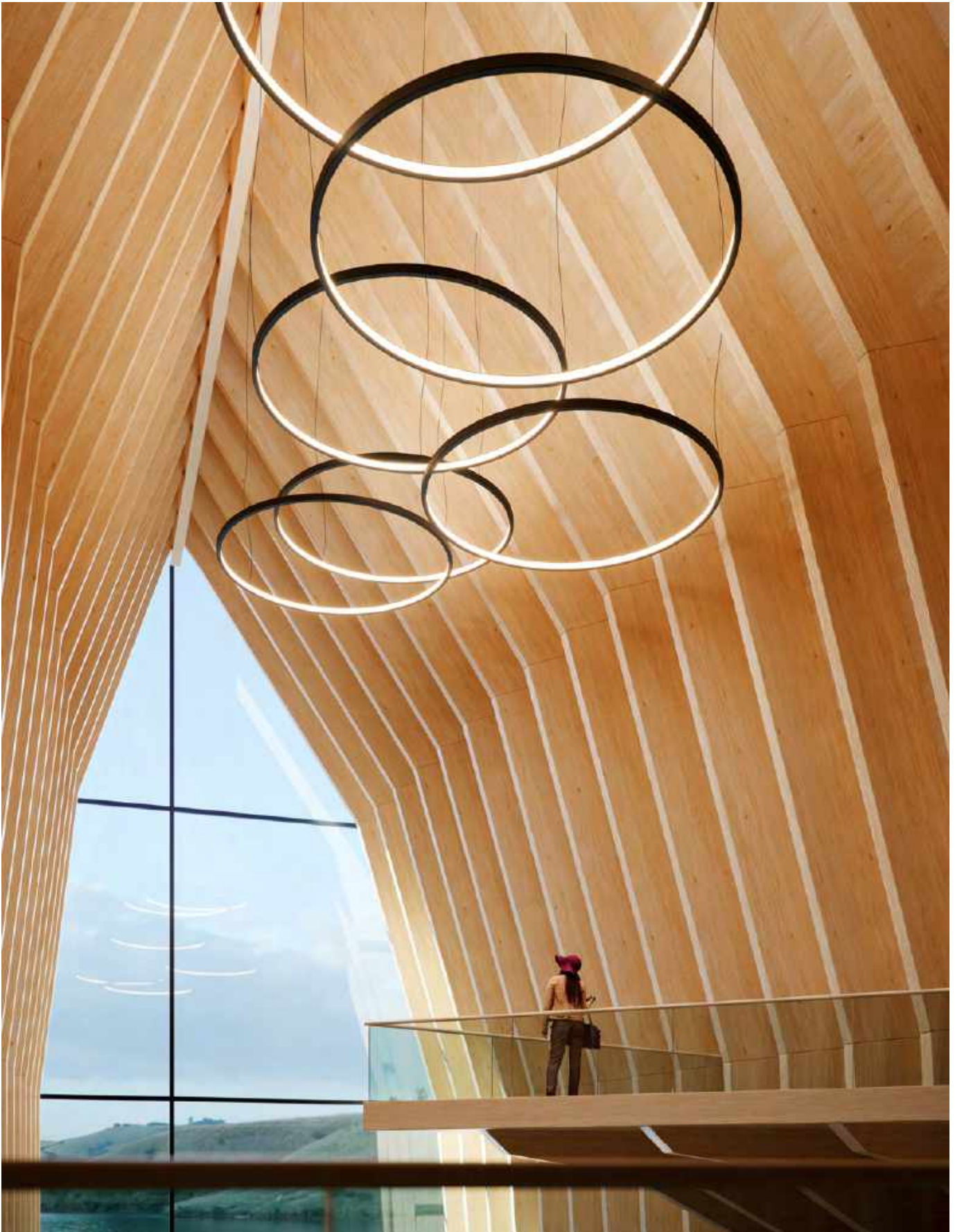





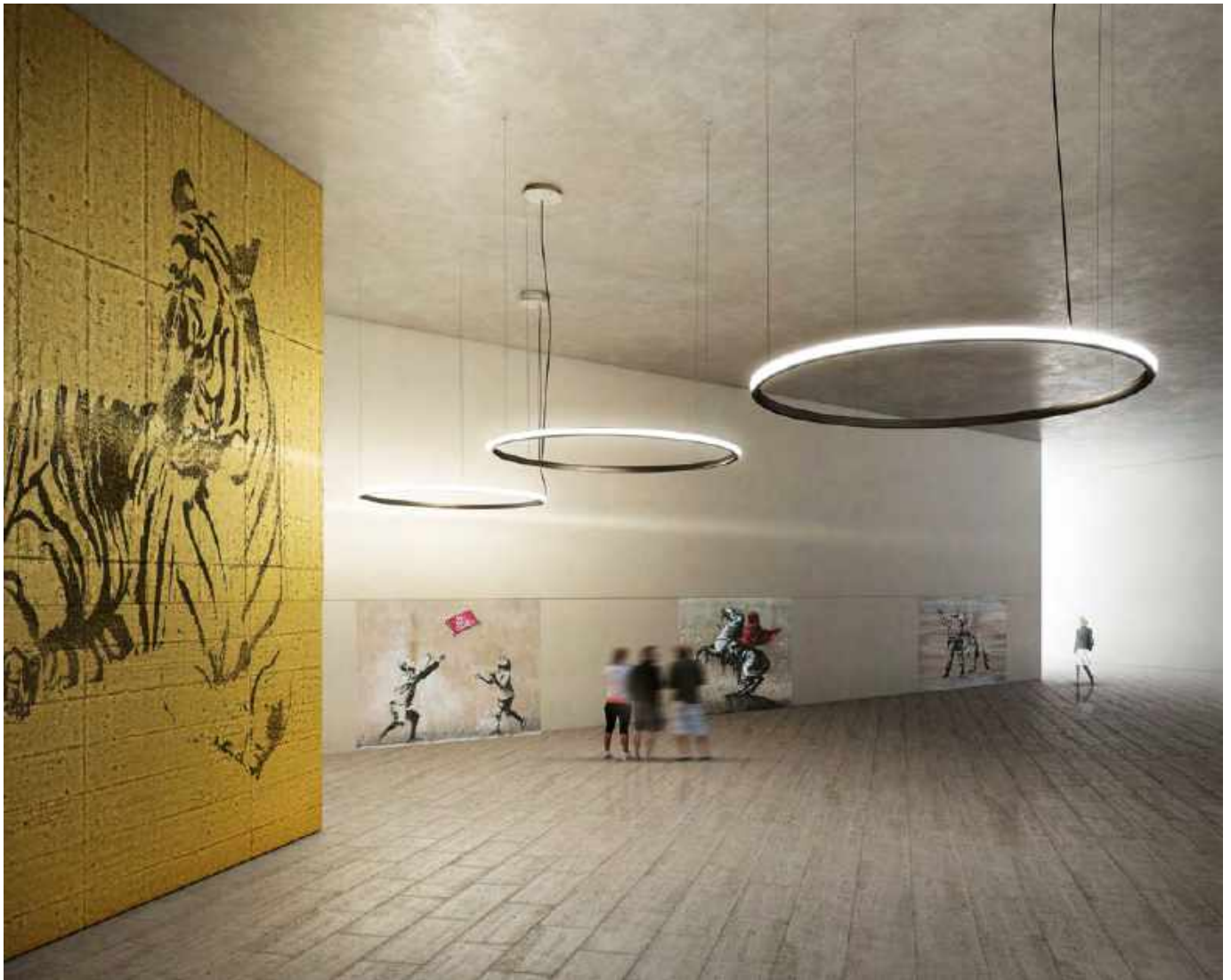















LOOP

circolare emissione luce interna / circular inner light emission



Apparecchio a sospensione a emissione di luce interna diffusa. Composto da settori curvi in profilato di alluminio estruso verniciato, che uniti tra loro con giunti formano anelli di diverso diametro, sospesi con cavi in acciaio. Diffusore in policarbonato opal bianco.

Sorgente di luce LED integrata.

Alimentatori elettronici dimmerabili inseriti all'interno del rosone da fissare al soffitto o nel controsoffitto.

Disponibile a richiesta 2700K e 4000K.

Suspension lamp, with diffused inner light emission, composed with curved modules in painted extruded aluminium sectors.

The union of these sectors with joints, offers different diameters rings, hanged by stainless steel cables.

White opal polycarbonate diffuser.

Integrated LED light source.

Electronic dimmable driver inside the ceiling rose or inside the false ceiling.

Available on request 2700K and 4000K.



watt	flusso/flux	CCT	Kg	colore/colour	codice/code
------	-------------	-----	----	---------------	-------------

LOOP Ø160

173W 230V	17000lm	3000K	16	<input type="radio"/> bianco/white <input type="radio"/> nero/black <input type="radio"/> oro p./p. gold <input type="radio"/> rame/copper	21003/160/DIM/BI 21003/160/DIM/NE 21003/160/DIM/AU 21003/160/DIM/CU
-----------	---------	-------	----	---	--

rosone al soffitto / ceiling rose Ø28 H6
alimentatori elettronici dimmerabili / electronic dimmable drivers

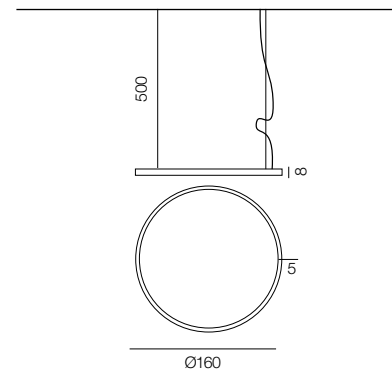
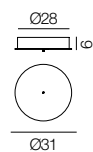
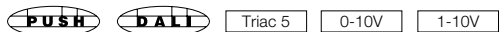

LOOP Ø200

216W 230V	21000lm	3000K	20	<input type="radio"/> bianco/white <input type="radio"/> nero/black <input type="radio"/> oro p./p. gold <input type="radio"/> rame/copper	21003/200/DIM/BI 21003/200/DIM/NE 21003/200/DIM/AU 21003/200/DIM/CU
-----------	---------	-------	----	---	--

rosone al soffitto / ceiling rose Ø28 H6
alimentatori elettronici dimmerabili / electronic dimmable drivers

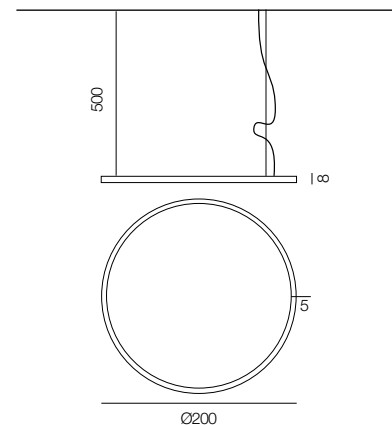
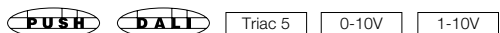

LOOP Ø300

325W 230V	31600lm	3000K	32	<input type="radio"/> bianco/white <input type="radio"/> nero/black <input type="radio"/> oro p./p. gold <input type="radio"/> rame/copper	21003/300/DIM/BI 21003/300/DIM/NE 21003/300/DIM/AU 21003/300/DIM/CU
-----------	---------	-------	----	---	--

rosone al soffitto / ceiling rose 2xØ28 H6
alimentatori elettronici dimmerabili / electronic dimmable drivers

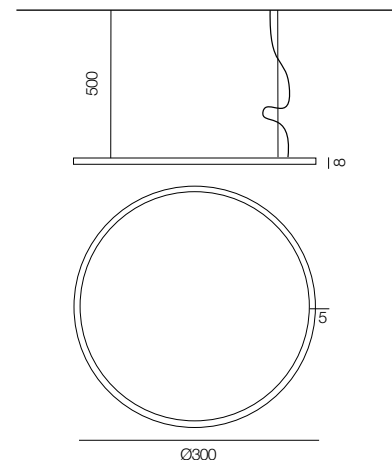
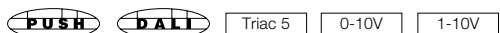

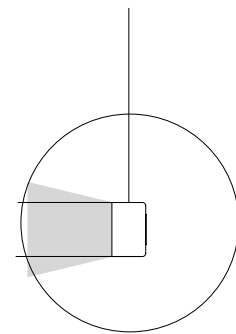
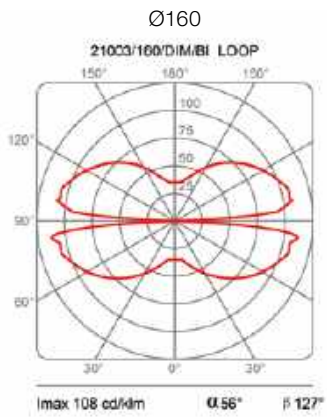

sezione profilo con emissione della luce
profile section with light emission

LOOP

circolare emissione luce esterna / circular outer light emission



Apparecchio a sospensione a emissione di luce esterna diffusa. Composto da settori curvi in profilato di alluminio estruso verniciato, che uniti tra loro con giunti formano anelli di diverso diametro, sospesi con cavi in acciaio. Diffusore in policarbonato opal bianco. Sorgente di luce LED integrata. Alimentatori elettronici dimmerabili inseriti all'interno del rosone da fissare al soffitto o nel controsoffitto. Disponibile a richiesta 2700K e 4000K. Disponibili a richiesta 5m e 9m.

Suspension lamp, with diffused outer light emission. Composed with curved modules in painted extruded aluminium sectors. The union of these sectors with joints, offers different diameters rings, hanged by stainless steel cables. White opal polycarbonate diffuser. Integrated LED light source. Electronic dimmable driver inside the ceiling rose or inside the false ceiling. Available on request 2700K and 4000K. Available on request 5m and 9m.



watt	flusso/flux	CCT	Kg	colore/colour	codice/code
------	-------------	-----	----	---------------	-------------

LOOP Ø160

163W 230V	15800lm	3000K	16	<input type="radio"/> bianco/white <input type="radio"/> nero/black <input type="radio"/> oro p./p. gold <input type="radio"/> rame/copper	21005/160/DIM/BI 21005/160/DIM/NE 21005/160/DIM/AU 21005/160/DIM/CU
-----------	---------	-------	----	---	--

rosone al soffitto / ceiling rose Ø28 H 6
 alimentatori elettronici dimmerabili / electronic dimmable drivers

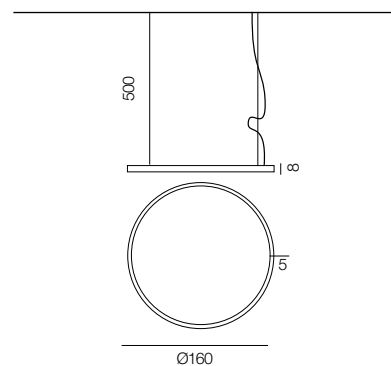
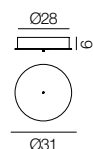
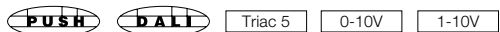

LOOP Ø200

206W 230V	20000lm	3000K	20	<input type="radio"/> bianco/white <input type="radio"/> nero/black <input type="radio"/> oro p./p. gold <input type="radio"/> rame/copper	21005/200/DIM/BI 21005/200/DIM/NE 21005/200/DIM/AU 21005/200/DIM/CU
-----------	---------	-------	----	---	--

rosone al soffitto / ceiling rose Ø28 H 6
 alimentatori elettronici dimmerabili / electronic dimmable drivers

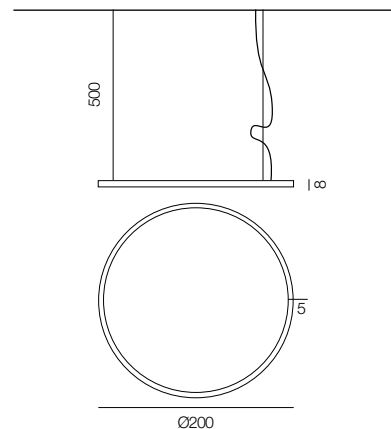
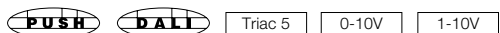

LOOP Ø300

314W 230V	30500lm	3000K	32	<input type="radio"/> bianco/white <input type="radio"/> nero/black <input type="radio"/> oro p./p. gold <input type="radio"/> rame/copper	21005/300/DIM/BI 21005/300/DIM/NE 21005/300/DIM/AU 21005/300/DIM/CU
-----------	---------	-------	----	---	--

rosone al soffitto / ceiling rose 2xØ28 H 6
 alimentatori elettronici dimmerabili / electronic dimmable drivers

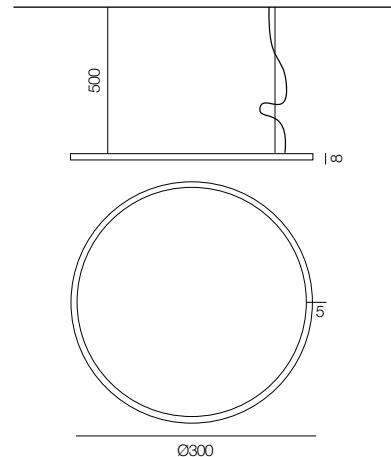

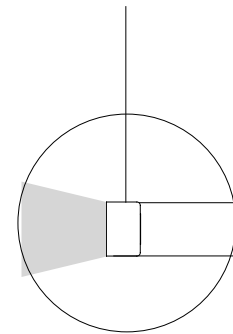
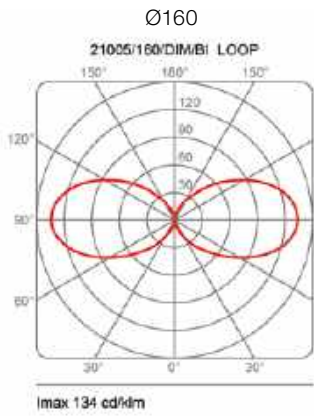
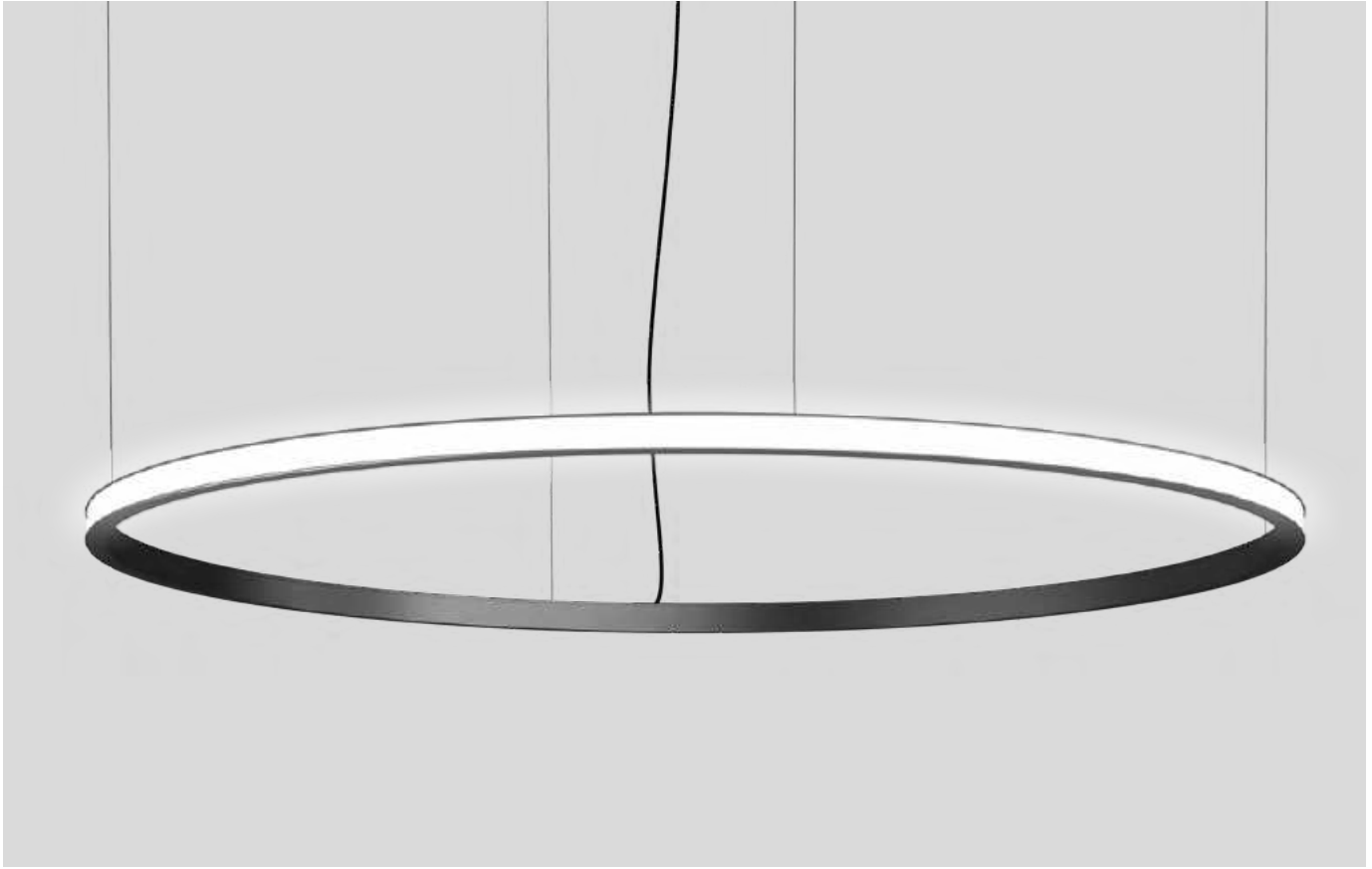

sezione profilo con emissione della luce
profile section with light emission

LOOP

quadrata emissione luce interna / square inner light emission



Apparecchio a sospensione a emissione di luce interna diffusa. Formato da profili lineari e curvi uniti con giunti, in alluminio verniciato. Sorgente di luce LED integrata. Alimentatori elettronici dimmerabili inseriti all'interno del rosone da fissare al soffitto o nel controsoffitto. Disponibile a richiesta a 2700K e 4000K.

Suspension lamp, with diffused inner light emission. Composed by linear and curved profiles connected with joints, in painted aluminium. Integrated LED light source. Electronic dimmable drivers inside the false ceiling or inside the ceiling rose. Available on request 2700K and 4000K.

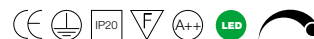

watt	flusso/flux	CCT	Kg	colore/colour	codice/code
------	-------------	-----	----	---------------	-------------

LOOP 170x170

207W 230V	20100lm	3000K	18,5	<input type="radio"/> bianco/white <input type="radio"/> nero/black <input type="radio"/> oro p./p. gold <input type="radio"/> rame/copper	21006/170/DIM/BI 21006/170/DIM/NE 21006/170/DIM/AU 21006/170/DIM/CU
-----------	---------	-------	------	---	--

rosone al soffitto / ceiling rose Ø28 H 6
 alimentatori elettronici dimmerabili / electronic dimmable drivers

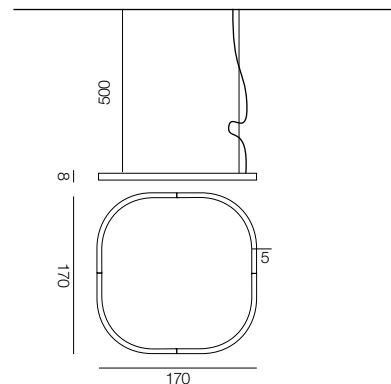
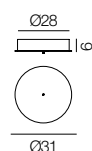

LOOP 250x250

329W 230V	32000lm	3000K	28	<input type="radio"/> bianco/white <input type="radio"/> nero/black <input type="radio"/> oro p./p. gold <input type="radio"/> rame/copper	21006/250/DIM/BI 21006/250/DIM/NE 21006/250/DIM/AU 21006/250/DIM/CU
-----------	---------	-------	----	---	--

rosone al soffitto / ceiling rose 2xØ28 H 6
 alimentatori elettronici dimmerabili / electronic dimmable drivers

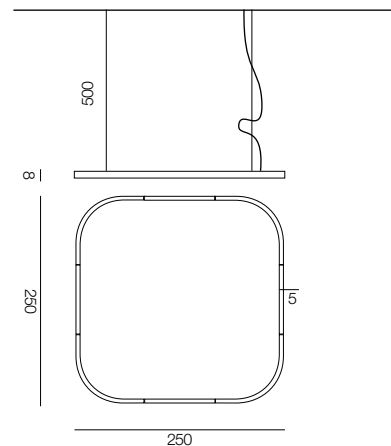
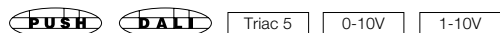

LOOP RETTANGOLARE / RECTANGULAR 170x370

374W 230V	36600lm	3000K	32	<input type="radio"/> bianco/white <input type="radio"/> nero/black <input type="radio"/> oro p./p. gold <input type="radio"/> rame/copper	21010/DIM/BI 21010/DIM/NE 21010/DIM/AU 21010/DIM/CU
-----------	---------	-------	----	---	--

rosone al soffitto / ceiling rose 2xØ28 H 6
 alimentatori elettronici dimmerabili / electronic dimmable drivers

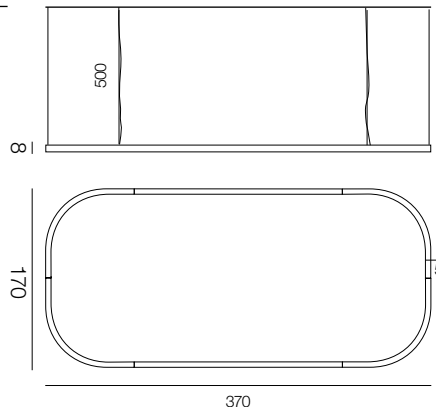
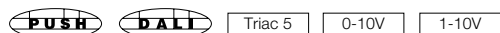

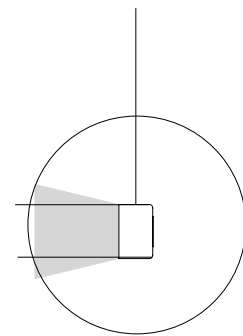
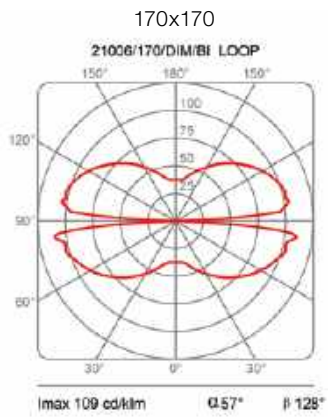

sezione profilo con emissione della luce
profile section with light emission

LOOP

quadrata emissione luce esterna / square outer light emission



Apparecchio a sospensione a emissione di luce esterna diffusa. Formato da profili lineari e curvi uniti con giunti, in alluminio verniciato. Sorgente di luce LED integrata. Alimentatori elettronici dimmerabili inseriti all'interno del rosone da fissare al soffitto o nel controsoffitto. Disponibile a richiesta 2700K e 4000K.

Suspension lamp, with diffused outer light emission. Composed by linear profiles and curved profiles connected with joints, in painted aluminium. Integrated LED light source. Electronic dimmable drivers inside the false ceiling or inside the ceiling rose. Available on request 2700K and 4000K.

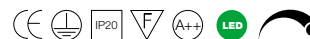

watt	flusso/flux	CCT	Kg	colore/colour	codice/code
------	-------------	-----	----	---------------	-------------

LOOP 170x170

197W 230V	19200lm	3000K	18,5	<input type="radio"/> bianco/white <input type="radio"/> nero/black <input type="radio"/> oro/gold <input type="radio"/> rame/copper	21007/170/DIM/BI 21007/170/DIM/NE 21007/170/DIM/AU 21007/170/DIM/CU
-----------	---------	-------	------	---	--

rosone al soffitto / ceiling rose Ø28 H 6
 alimentatori elettronici dimmerabili / electronic dimmable drivers

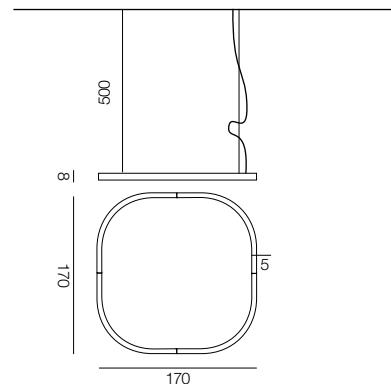
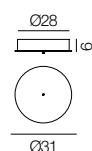
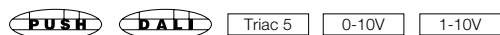

LOOP 250x250

320W 230V	31100lm	3000K	28	<input type="radio"/> bianco/white <input type="radio"/> nero/black <input type="radio"/> oro/gold <input type="radio"/> rame/copper	21007/250/DIM/BI 21007/250/DIM/NE 21007/250/DIM/AU 21007/250/DIM/CU
-----------	---------	-------	----	---	--

rosone al soffitto / ceiling rose 2xØ28 H 6
 alimentatori elettronici dimmerabili / electronic dimmable drivers

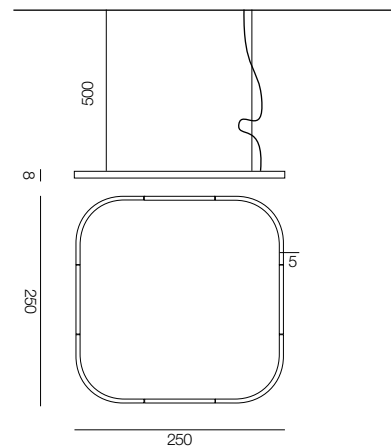
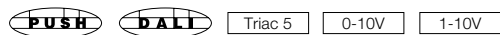

LOOP RETTANGOLARE / RECTANGULAR 170x370

364W 230V	35700lm	3000K	32	<input type="radio"/> bianco/white <input type="radio"/> nero/black <input type="radio"/> oro/gold <input type="radio"/> rame/copper	21011/DIM/BI 21011/DIM/NE 21011/DIM/AU 21011/DIM/CU
-----------	---------	-------	----	---	--

rosone al soffitto / ceiling rose 2xØ28 H 6
 alimentatori elettronici dimmerabili / electronic dimmable drivers

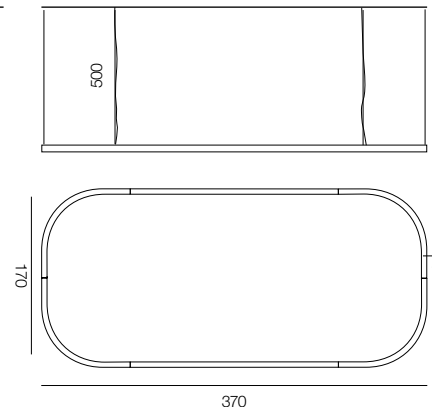
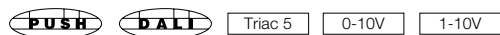

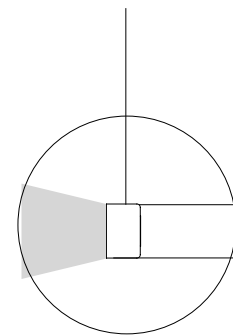
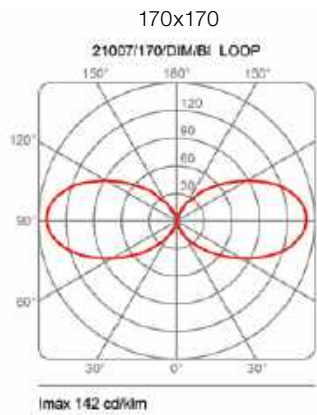
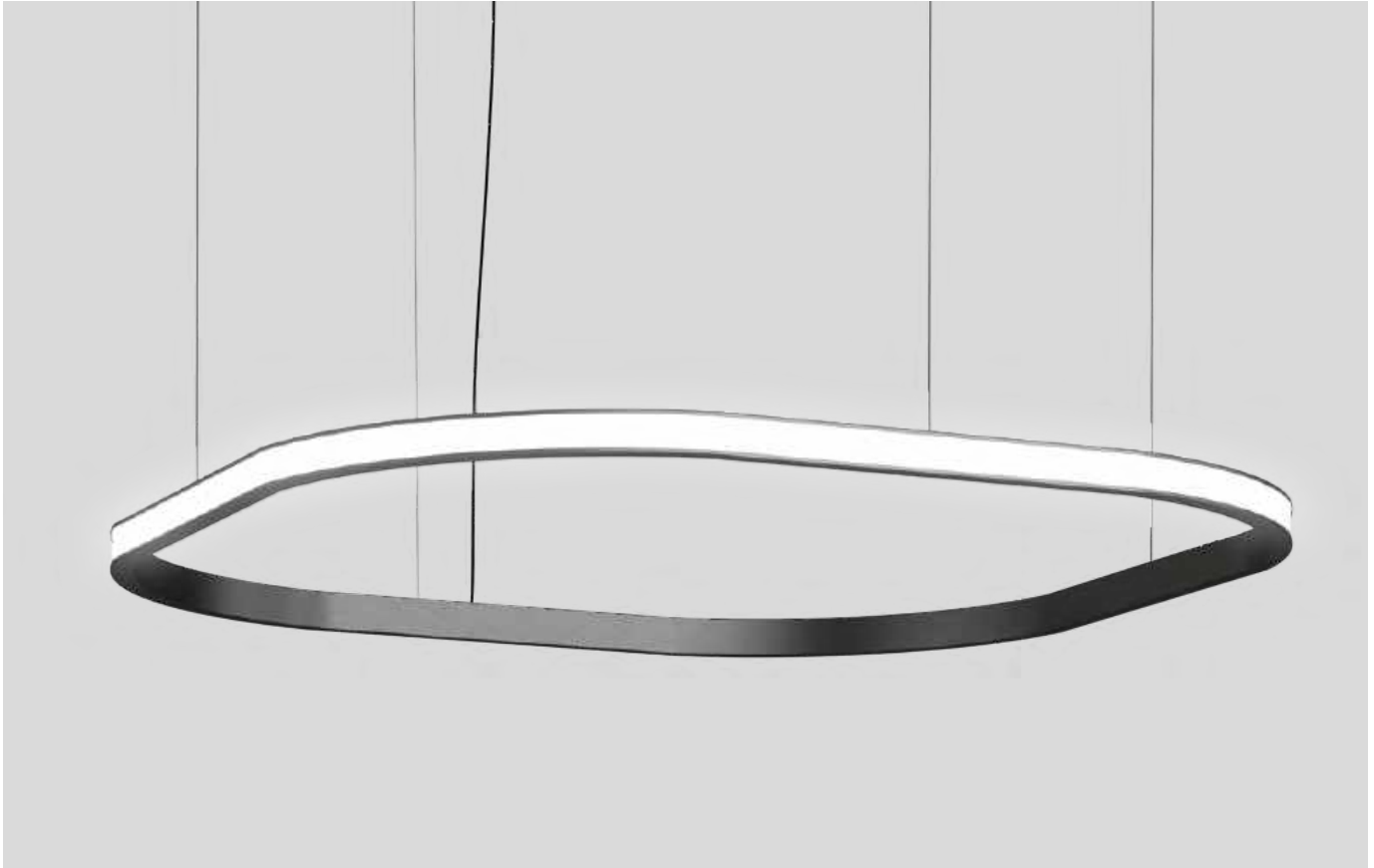

sezione profilo con emissione della luce
profile section with light emission

LOOP

lineare orientabile / adjustable linear



Apparecchio a emissione di luce diffusa orientabile, da sospendere come profilo singolo o da unire ad altri profili tramite un giunto che permette la rotazione indipendente tra i moduli. Diffusore in policarbonato opal bianco. Sorgente di luce a LED integrata. Alimentatori elettronici dimmerabili inseriti all'interno del rosone o nel controsoffitto.

Suspension device, with adjustable diffused light emission, it can be suspended as a single profile or joined together with other profiles by means of a joint that allows independent rotation between the modules. White opal polycarbonate diffuser. Integrated LED light source. Electronic dimmable drivers inside the ceiling rose or inside the false ceiling.



watt	flusso/flux	CCT	Kg	colore/colour	codice/code
MODULO/MODULE					
72W 230V	7000lm	3000K	7	<ul style="list-style-type: none"> bianco/white nero/black oro p./p. gold rame/copper 	<ul style="list-style-type: none"> 40055/200/DIM/BI 40055/200/DIM/NE 40055/200DIM/AU 40055/200/DIM/CU

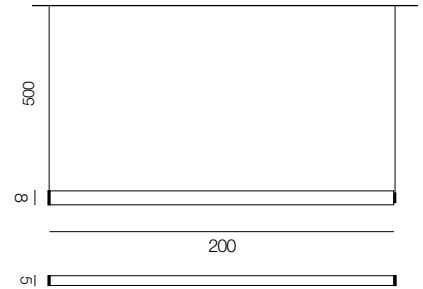

giunto intermedio / intermediate joint (A)	0,5	<ul style="list-style-type: none"> bianco/white nero/black oro p./p. gold rame/copper 	<ul style="list-style-type: none"> 40056/BI 40056/NE 40056/AU 40056/CU
giunto terminale / terminal joint (B)	0,5	<ul style="list-style-type: none"> bianco/white nero/black oro p./p. gold rame/copper 	<ul style="list-style-type: none"> 40057/BI 40057/NE 40057/AU 40057/CU

rosone con alimentatore dimmerabile / ceiling rose with dimmable driver (max 2 moduli / modules)	240W	1,5	<ul style="list-style-type: none"> bianco/white nero/black oro p./p. gold rame/copper 	<ul style="list-style-type: none"> 40058/BI 40058/NE 40058/AU 40058/CU
--	------	-----	---	--

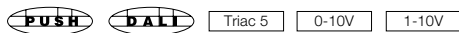
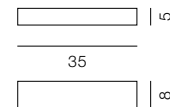

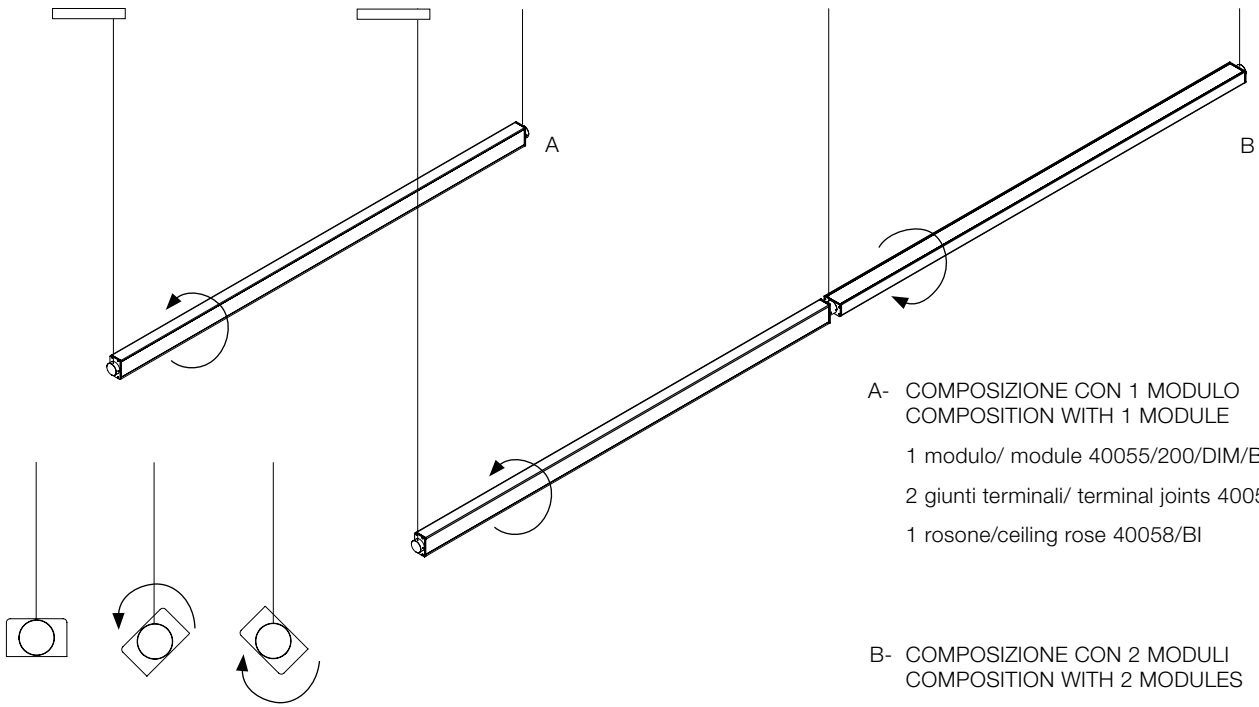

A- COMPOSIZIONE CON 1 MODULO
 COMPOSITION WITH 1 MODULE
 1 modulo/ module 40055/200/DIM/BI
 2 giunti terminali/ terminal joints 40057/BI
 1 rosone/ceiling rose 40058/BI

B- COMPOSIZIONE CON 2 MODULI
 COMPOSITION WITH 2 MODULES
 2 moduli/modules 40055/200/DIM/BI
 2 giunti terminali/terminal joints 40057/BI
 1 giunto intermedio/intermediate joint 40056/BI
 1 rosone/ceiling rose 40058/BI

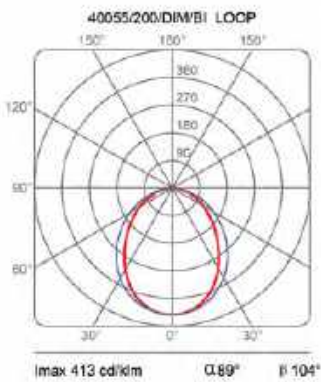

h (m)	α	E _m (lux)
h1	2.0/2.6	660
h2	3.9/5.1	170
h3	5.8/7.7	78
h4	7.8/10.3	43
h5	9.8/12.9	27

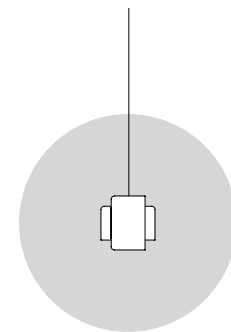

sezione profilo con emissione della luce
 profile section with light emission

LOOP

lineare doppio / double linear

Apparecchio a sospensione, emissione di luce diffusa interna e esterna. Formato da due profili lineari accoppiati tra loro, in alluminio verniciato. Diffusore in policarbonato opal bianco. Sorgente di luce LED integrata. Alimentatori elettronici dimmerabili inseriti all'interno del rosone da fissare al soffitto o nel controsoffitto. Disponibile a richiesta 2700K e 4000K.

Suspension lamp, inner and outer diffused light emission. Composed of two linear profiles joined together, with an aluminium painted joint. White opal polycarbonate diffuser. Integrated LED light source. Electronic dimmable drivers inside the ceiling rose or inside the false ceiling. Available on request 2700K, 4000K.

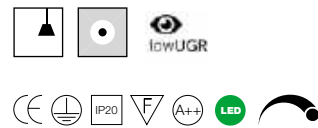

watt	flusso/flux	CCT	Kg	colore/colour	codice/code
LOOP 200					
2x72W 230V	2x7000lm	3000K	13	<ul style="list-style-type: none"> bianco/white nero/black oro p./p. gold rame/copper 	<ul style="list-style-type: none"> 21008/200/DIM/BI 21008/200/DIM/NE 21008/200DIM/AU 21008/200/DIM/CU

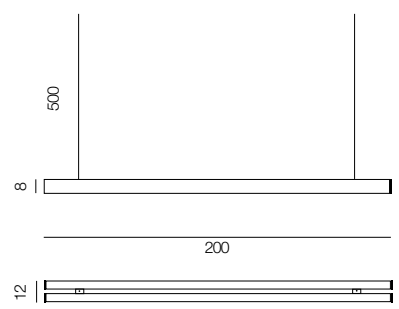

rosone al soffitto / ceiling rose L 35x8 H5
 alimentatori elettronici dimmerabili / electronic dimmable drivers

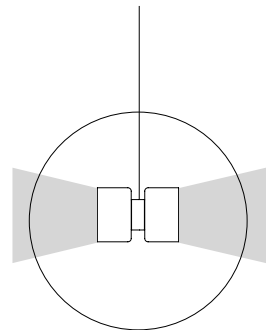
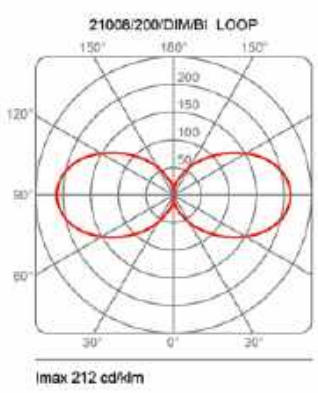
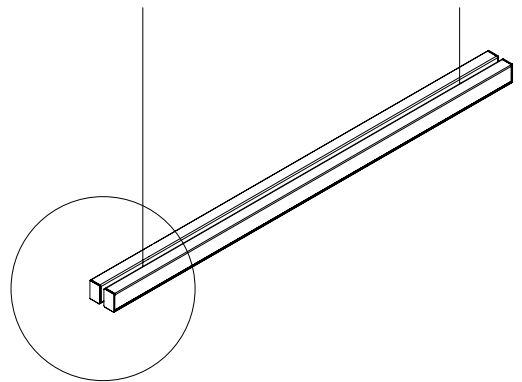
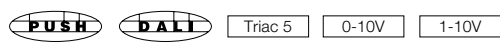

sezione profilo con emissione della luce
 profile section with light emission



LOOP

faretti / spot

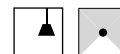

Il sistema si è ampliato di un faretto singolo e di un kit con tre farette orientabili da posizionare tramite un supporto con pomello di fissaggio alla lampada Loop nelle sue versioni.

Sorgente di luce a LED integrata.

Alimentatore da inserire all'interno del rosone al soffitto o remoto.

This system has been improved by adding a single spotlight or a kit of three adjustable spots to be fixed through a mounting knob support, to the inner light version of the Loop system.

Integrated LED light source.

With driver to be placed inside the ceiling rose or remotely.



watt	beam	flusso/flux	CCT	Kg	colore/colour	codice/code
------	------	-------------	-----	----	---------------	-------------

KIT 1 FARETTO / KIT 1 SPOTLIGHTS

per Loop a luce interna e esterna / for Loop with inner and outer light

9W 500mA	narrow	1100lm	3000K	0,5	○ bianco/white	40088/BI
					● nero/black	40088/NE
					● oro perlato/golden	40088/AU
					● rame/copper	40088/CU

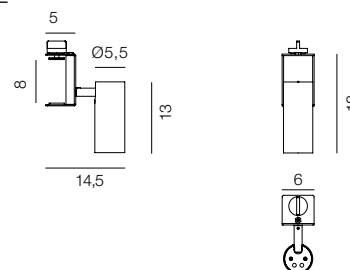

KIT 3 FARETTI / KIT 3 SPOTLIGHTS

solo per Loop a luce interna / only for Loop with inner light Ø160 - Ø200

3x9W 500mA	narrow	3x1100lm	3000K	1,8	○ bianco/white	40091/BI
					● nero/black	40091/NE
					● oro p./p. gold	40091/AU
					● rame/copper	40091/CU

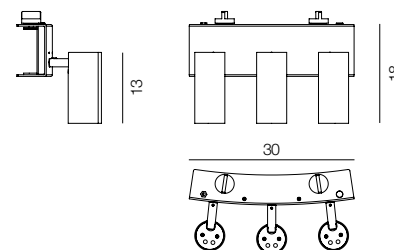

KIT 3 FARETTI / KIT 3 SPOTLIGHTS

solo per Loop a luce interna / only for Loop with inner light Ø300

3x9W 500mA	narrow	3x1100lm	3000K	1,8	○ bianco/white	40093/BI
					● nero/black	40093/NE
					● oro p./p. gold	40093/AU
					● rame/copper	40093/CU

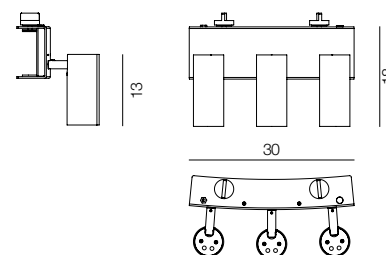

KIT 3 FARETTI / KIT 3 SPOTLIGHTS

solo per Loop lineare e quadrata / only for linear and square Loop

3x9W 500mA	narrow	3x1100lm	3000K	1,8	○ bianco/white	40095/BI
					● nero/black	40095/NE
					● oro p./p. gold	40095/AU
					● rame/copper	40095/CU

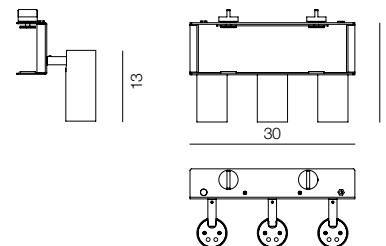



watt	Kg	colore/colour	codice/code
------	----	---------------	-------------

ALIMENTATORE REMOTO max 5 faretto / REMOTE DRIVER up to 5 spots			
60W - 230V	0,4		40096

ROSONE A SOFFITTO / CEILING ROSE
 con alimentatore per 2 linee di max 2x5 faretto / with driver for 2 lines up to 2x5 spots

2x60W - 230V	1,4	○ bianco/white	40097/BI
2x60W - 230V	1,4	● nero/black	40097/NE
2x60W - 230V	1,4	● oro p./p. gold	40097/AU
2x60W - 230V	1,4	● rame/copper	40097/CU

ACCESSORIO ANTIABBLIAMENTO / ANTI-GLARE ACCESSORY



○ bianco/white	40128/BI
● nero/black	40128/NE
● oro p./p. gold	40128/AU
● rame/copper	40128/CU

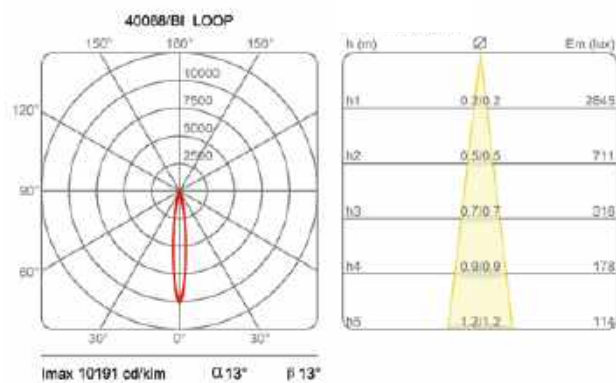
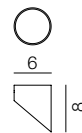



LUNAOP

LIGHTYOU LIKE



Un segno grafico illumina lo spazio. Una sospensione con sorgente luminosa a Led, caratterizzata da un minimo impatto visivo.

Progettato per garantire un alto rendimento luminoso, in tre diversi diametri, componibili, adatto per illuminare sia ambienti pubblici che ambienti domestici.

A graphic sign illuminates the space. A suspension lamp with LED light source, characterized by a minimal visual impact.

Designed to guarantee high luminous efficiency, it comes in three different modular diameters, and is ideal to illuminate both public and domestic environments.









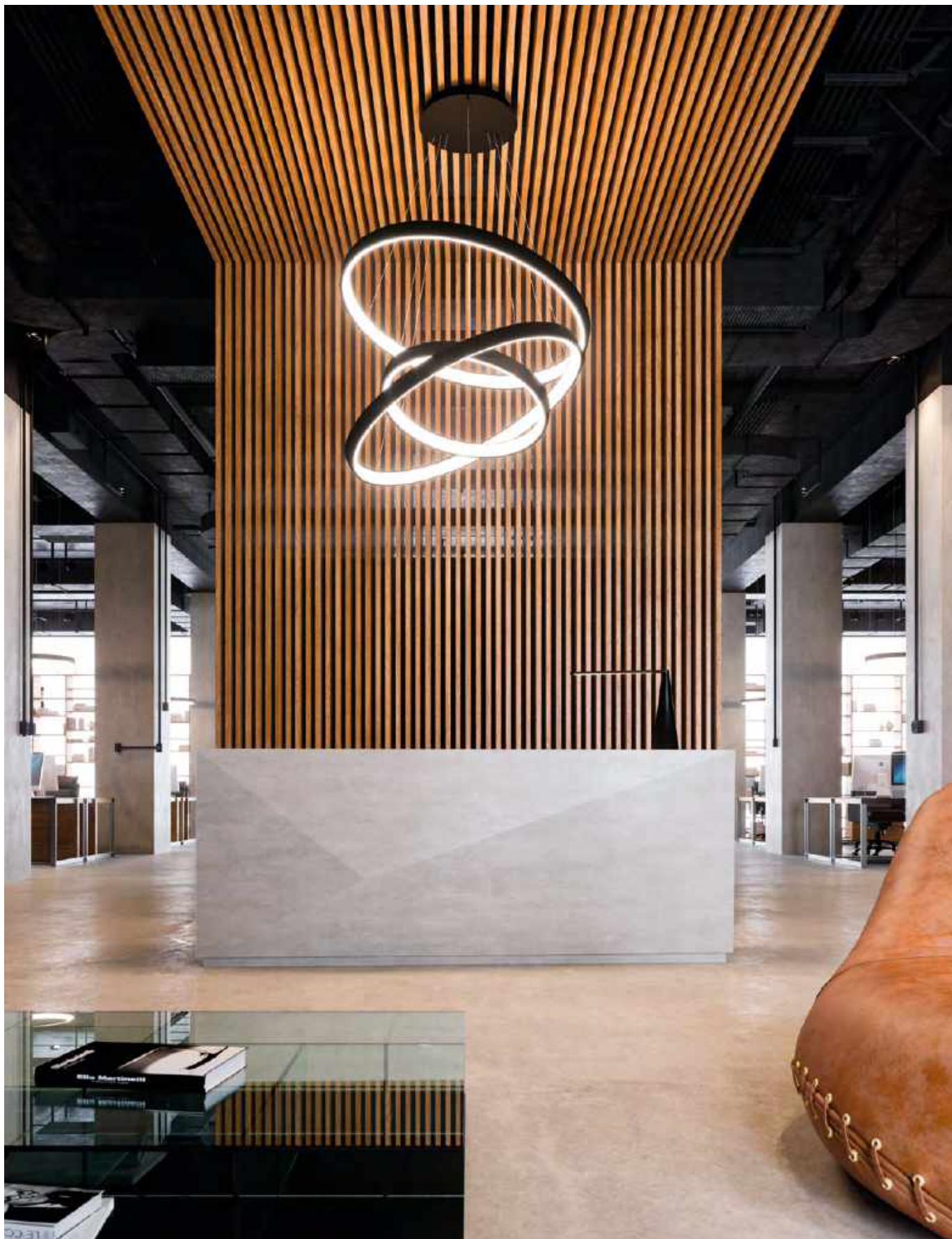







LUNAOP

sospensione / suspension



Lampada a sospensione a luce diffusa.
Struttura in alluminio verniciato nei colori bianco, nero, oro perlato o rame. Diffusore in metacrilato opal bianco. Disponibile in tre diametri (120, 80, 50) sospesa con i cavi di alimentazione da collegare ad un rosone da fissare al soffitto sia per la versione singola, sia per la versione composta (da 2 fino a 6 Lunaop). Sorgente di luce a LED integrata a 2700K, 3000K o 4000K. Alimentatore elettronico integrato nel rosone.

Suspension lamp with diffused light.
White, black, pearly gold or copper aluminium structure. White opal methacrylate diffuser.
Three diameters (120, 80, 50), suspended with power cables to be connected to a ceiling rose and mounted on the ceiling for both single and multiple versions (consisting of 2 to 6 Lunaop rings).
Integrated LED light source (2700K, 3000K or 4000K).
Electronic driver integrated in the ceiling rose.

watt	flusso/flux	CCT	Kg	colore/colour	codice/code
LUNAOP Ø50					
48W 24V	3700lm	2700K	2	○ bianco/white	40001/2700/BI
				● nero/black	40001/2700/NE
				● oro p./p. gold	40001/2700/AU
				● rame/copper	40001/2700/CU
		3000K	○ bianco/white	40001/3000/BI	
				● nero/black	40001/3000/NE
				● oro p./p. gold	40001/3000/AU
				● rame/copper	40001/3000/CU
		4000K	○ bianco/white	40001/4000/BI	
				● nero/black	40001/4000/NE
				● oro p./p. gold	40001/4000/AU
				● rame/copper	40001/4000/CU

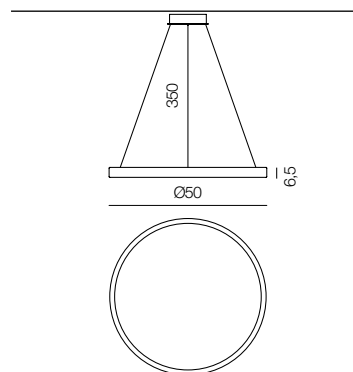

LUNAOP Ø80					
72W 24V	5600lm	2700K	2	○ bianco/white	40002/2700/BI
				● nero/black	40002/2700/NE
				● oro p./p. gold	40002/2700/AU
				● rame/copper	40002/2700/CU
		3000K	○ bianco/white	40002/3000/BI	
				● nero/black	40002/3000/NE
				● oro p./p. gold	40002/3000/AU
				● rame/copper	40002/3000/CU
		4000K	○ bianco/white	40002/4000/BI	
				● nero/black	40002/4000/NE
				● oro p./p. gold	40002/4000/AU
				● rame/copper	40002/4000/CU

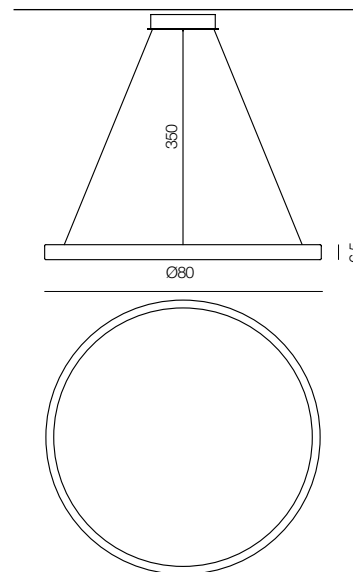



Farmacia comunale 3, Camaione, Lucca – arch. Simone Bruni

LUNAOP

sospensione / suspension

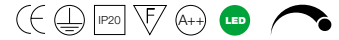

watt	flusso/flux	CCT	Kg	colore/colour	codice/code
LUNAOP Ø120					
108W 24V	8400lm	2700K	5	○ bianco/white	40003/2700/BI
				● nero/black	40003/2700/NE
				● oro p./p. gold	40003/2700/AU
				● rame/copper	40003/2700/CU
		3000K	○ bianco/white	40003/3000/BI	
				● nero/black	40003/3000/NE
				● oro p./p. gold	40003/3000/AU
				● rame/copper	40003/3000/CU
		4000K	○ bianco/white	40003/4000/BI	
				● nero/black	40003/4000/NE
				● oro p./p. gold	40003/4000/AU
				● rame/copper	40003/4000/CU

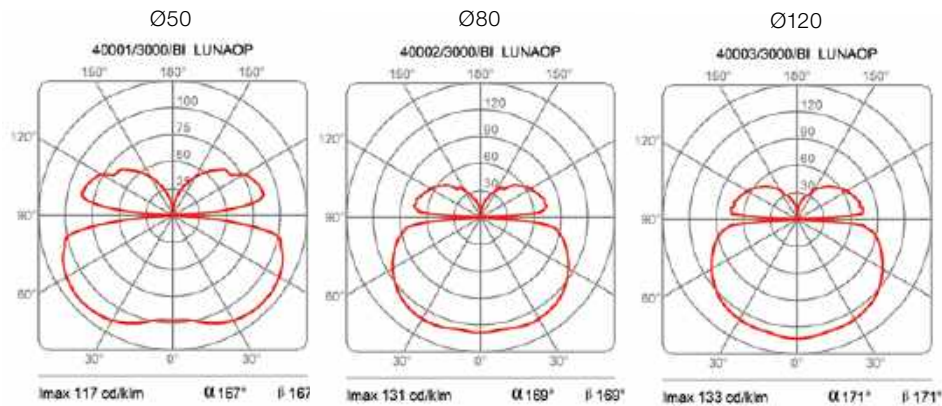
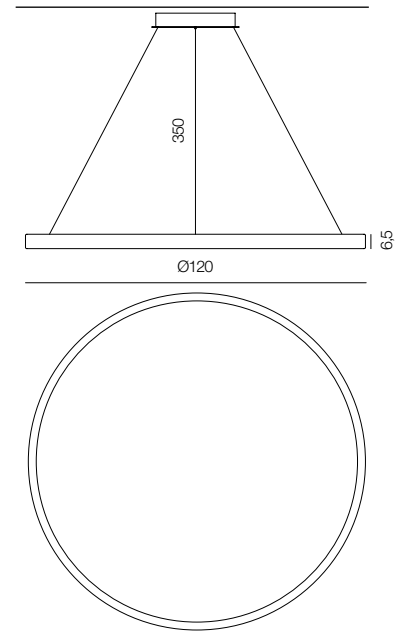



Pelletterie Giancarlo, Scandicci, Firenze – arch. Giorgio Ciliberti, Toscana Contract.

LUNAOP

rosoni con alimentatore / ceiling rose with driver

Rosone per Lunaop da ordinare insieme all'anello con il wattaggio corrispondente alle lampade utilizzate.

È disponibile il dispositivo bluetooth  da inserire nel rosone per dimmerarla (codice 40017).

Ceiling rose support for Lunaop to be ordered together with the ring, and the corresponding wattage accordingly to the chosen lamps.

The bluetooth device is available to be inserted in the ceiling rose (code 40017). 



NON DIMMERABILE / NON DIMMABLE

DIMMERABILE / DIMMABLE

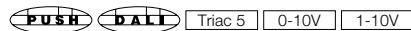

watt	colore/colour	codice/code
1 LUNAOP (A)		
75W	bianco/white	40004/BI
230/24V	nero/black	40004/NE
	oro p. /p.gold	40004/AU
0,8Kg	rame/copper	40004/CU
1-2 LUNAOP (B)		
150W	bianco/white	40007/BI
230/24V	nero/black	40007/NE
	oro p. /p.gold	40007/AU
1,3Kg	rame/copper	40007/CU
2-3 LUNAOP (C)		
2x150W	bianco/white	40010/BI
230/24V	nero/black	40010/NE
	oro p. /p.gold	40010/AU
2,1Kg	rame/copper	40010/CU
4-5-6 LUNAOP (D)		
3x150W	bianco/white	40014/BI
230/24V	nero/black	40014/NE
	oro p. /p.gold	40014/AU
2,7Kg	rame/copper	40014/CU
kit alimentatore remoto / remote driver kit		
75W 0,8	bianco/white	40004.1/BI
150W 0,8	bianco/white	40007.1/BI

watt	colore/colour	codice/code
1 LUNAOP (A)		
75W	bianco/white	40005/BI
230/24V	nero/black	40005/NE
	oro p. /p.gold	40005/AU
0,8Kg	rame/copper	40005/CU
1-2 LUNAOP (B)		
150W	bianco/white	40008/BI
230/24V	nero/black	40008/NE
	oro p. /p.gold	40008/AU
1,5Kg	rame/copper	40008/CU
2-3 LUNAOP (C)		
2x150W	bianco/white	40011/BI
	nero/black	40011/NE
	oro p. /p.gold	40011/AU
2,5Kg	rame/copper	40011/CU
4-5-6 LUNAOP (D)		
3x150W	bianco/white	40015/BI
230/24V	nero/black	40015/NE
	oro p. /p. gold	40015/AU
2,7Kg	rame/copper	40015/CU
kit alimentatore remoto / remote driver kit		
75W 0,8	bianco/white	40005.1/BI
150W 0,8	bianco/white	40008.1/BI

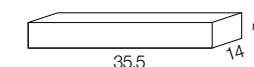
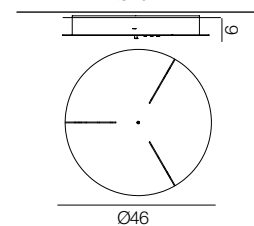
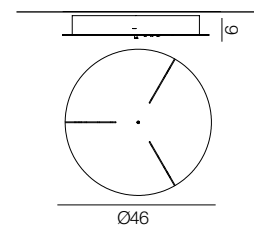
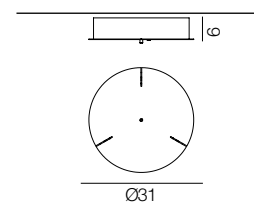
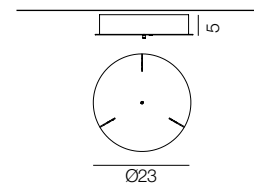

ROSONI CON ALIMENTATORE DIMMERABILI / CEILING ROSES WITH DIMMABLE DRIVER

LUNAOP Ø50-Ø80 		
75W	bianco/white	40013/BI
230/24V	nero/black	40013/NE
	oro p. /p.gold	40013/AU
0,8Kg	rame/copper	40013/CU

LUNAOP Ø120 		
150W	bianco/white	544.1K/BI
230/24V	nero/black	544.1K/NE
	oro p. /p.gold	544.1K/AU
1,5Kg	rame/copper	544.1K/CU

La scelta del codice del rosone nelle diverse composizioni è legato alla somma dei Watt dei singoli anelli ed al tipo di dimmerazione.

The choice of the ceiling rose in the different compositions code is related to the watts sum of the different rings and the type of dimmeration.

ESEMPI DI COMPOSIZIONE / EXAMPLES OF COMPOSITION

ANELLO+ROSONE / RING+CEILING ROSE

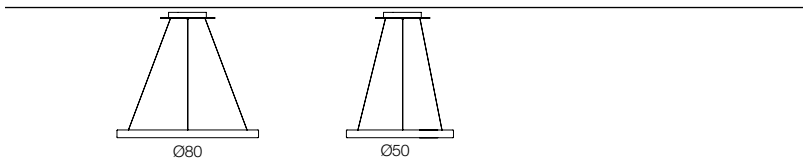

- A** LUNAOP Ø50 48W
 40001+40004 non dimmerabile/non dimmable
 40001+40005 dimmerabile/dimmable
 LUNAOP Ø80 72W
 40002+40004 non dimmerabile/non dimmable
 40002+40005 dimmerabile/dimmable

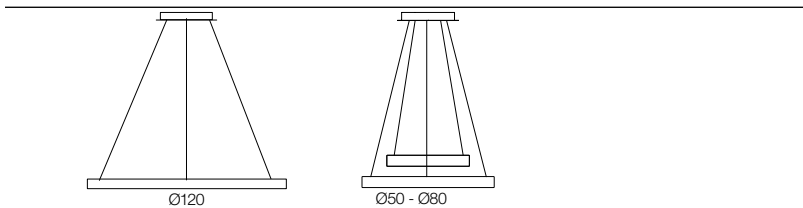

- B** LUNAOP Ø120 108W
 40003+40007 non dimmerabile/non dimmable
 40003+40008 dimmerabile/dimmable
 LUNAOP Ø50 + Ø80 48W+72W
 40001+40002+40007 non dimmerabile/non dimmable
 40001+40002+40008 dimmerabile/dimmable

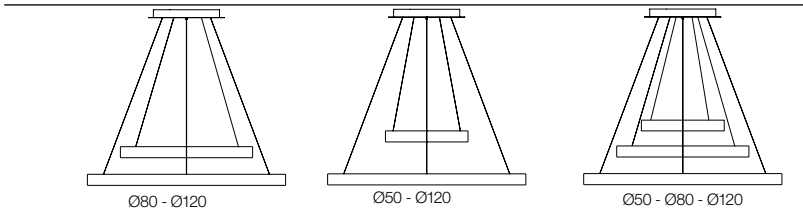

- C** LUNAOP Ø80 + Ø120 72W+108W
 40002+40003+40010 non dimmerabile/non dimmable
 40002+40003+40011 dimmerabile/dimmable
 LUNAOP Ø50 + Ø120 48W+108W
 40001+40003+40010 non dimmerabile/non dimmable
 40001+40003+40011 dimmerabile/dimmable
 LUNAOP Ø50 + Ø80 Ø120 48W+72W+108W
 40001+40002+40003+40010 non dimmerabile/non dimmable
 40001+40002+40003+40011 dimmerabile/dimmable

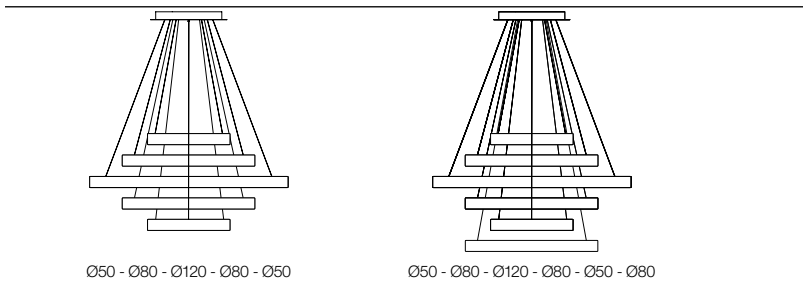

- D** LUNAOP 2xØ50 + 2xØ80 + 1xØ120
 2x48W + 2x72W + 1x108W
 2x40001+2x40002+1x40003+40014 non dimmerabile/non dimmable
 2x40001+2x40002+1x40003+40015 dimmerabile/dimmable
 LUNAOP 2xØ50 + 3xØ80 + 1xØ120
 2x48W + 3x72W + 1x108W
 2x40001+3x40002+1x40003+40014 non dimmerabile/non dimmable
 2x40001+3x40002+1x40003+40015 dimmerabile/dimmable

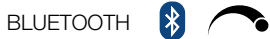

dispositivo bluetooth per dimmerazione da inserire nel rosone (non dimmerabile)

40017

bluetooth device for dimming to be inserted in the ceiling rose (non dimmable)

LUNAOP

parete-soffitto / wall-ceiling

Lampada da soffitto o da parete a luce diffusa.
Struttura in alluminio verniciato nel colore bianco.
Diffusore in metacrilato opal bianco.
Sorgente di luce a LED integrata, alimentatore elettronico dimmerabile nel rosone fissato al corpo lampada.
Su richiesta senza rosone con alimentatore remoto.

Ceiling or wall lamp with diffused light.
White lacquered aluminium structure.
White opal methacrylate diffuser.
Integrated LED light source and dimmable electronic driver inside the ceiling rose fixed to the body lamp.
On request with remote driver and without ceiling rose.



watt	flusso/flux	CCT	Kg	colore/colour	codice/code
------	-------------	-----	----	---------------	-------------

LUNAOP Ø50

48W 230V	3700lm	3000K	2	○ bianco/white	2886/J/DIM/BI
----------	--------	-------	---	----------------	---------------

alimentatore elettronico dimmerabile integrato / integrated electronic dimmable driver

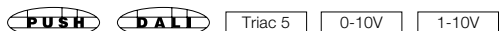

LUNAOP Ø80

72W 230V	5600lm	3000K	3	○ bianco/white	2886/DIM/BI
----------	--------	-------	---	----------------	-------------

alimentatore elettronico dimmerabile integrato / integrated electronic dimmable driver

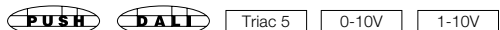

LUNAOP Ø120

108W 230V	3700lm	8400K	5	○ bianco/white	2886/G/DIM/BI
-----------	--------	-------	---	----------------	---------------

alimentatore elettronico dimmerabile integrato / integrated electronic dimmable driver

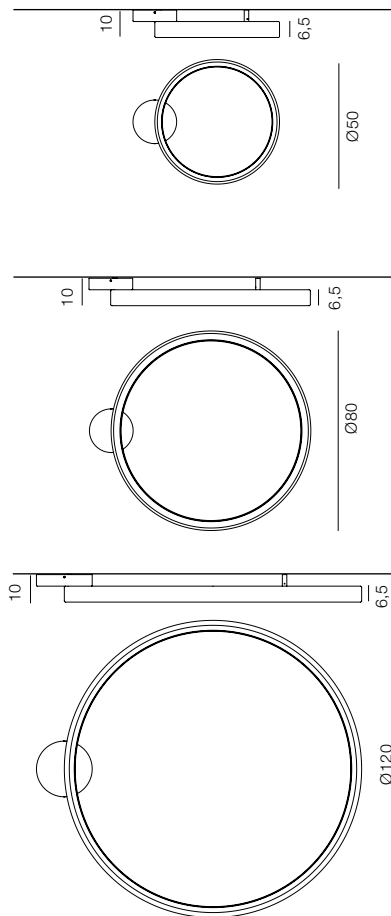
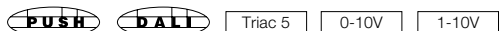

Ø50

Ø80

Ø120

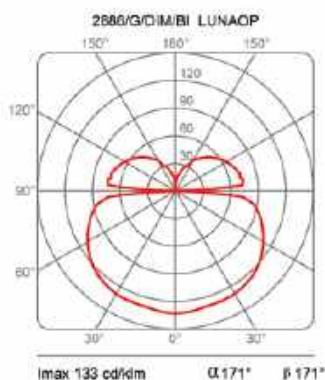
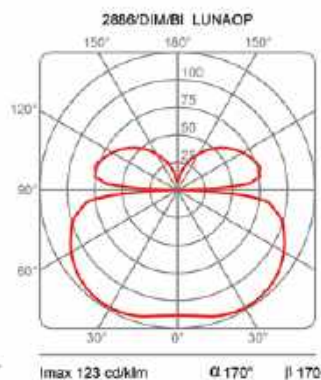
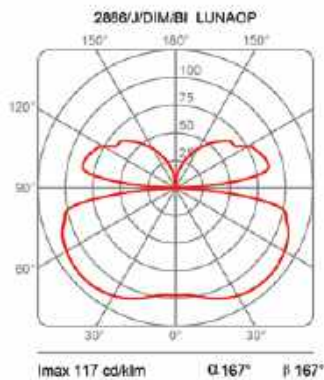





CIRCULAR SLIM



Una serie di anelli sospesi, sottili e leggeri. Disponibili nelle versioni a luce indiretta e diffusa, o a luce indiretta e diretta grazie agli spot con luce d'accento direzionabili. Il numero degli spots quattro o otto, varia in funzione del diametro dell'anello.

A series of pendant rings, lean and lightweight. Available in the indirect and diffused light version, or indirect and direct light, thanks to the adjustable spotlights with directional accentuated light. The number of spots – four or eight – varies based on the diameter of the ring.





CIRCULAR SLIM





CIRCULAR SLIM



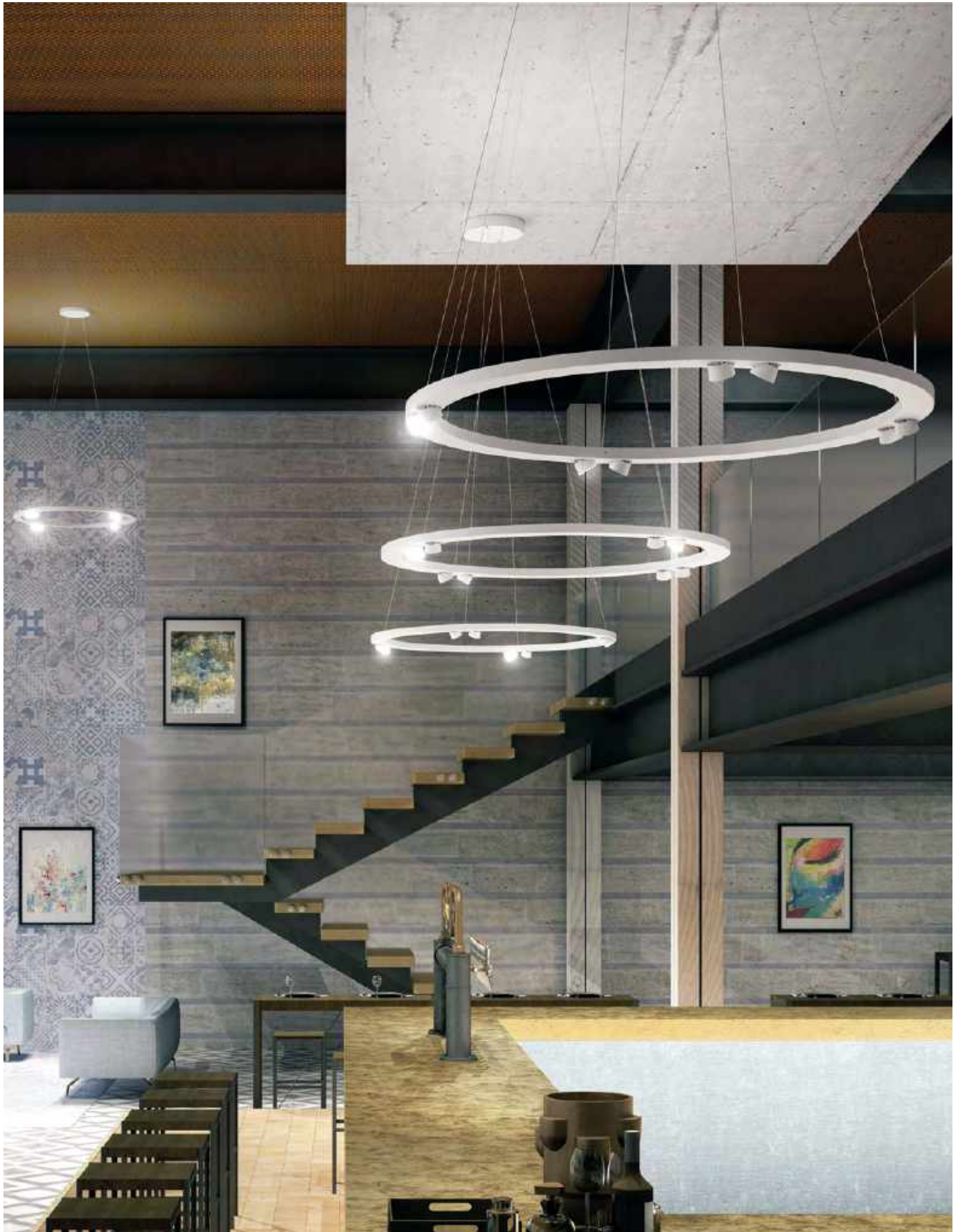

CIRCULAR SLIM

sospensione / suspension

Lampada a sospensione a luce indiretta, in alluminio verniciato nel colore bianco, oro perlato e rame.
Sospeso con i cavi di alimentazione da collegare al rosone. Alimentatori elettronici dimmerabili inseriti all'interno del rosone a soffitto.
A richiesta con LED bianco dinamico.
Disponibile in tre dimensioni.

Suspension lamp, indirect light, painted aluminium in white, pearly gold and copper colours.
Suspended with power cables to be connected to a ceiling rose. Electronic dimmable drivers inside the ceiling rose.
On request with dynamic white LED.
Aivalable in three sizes.



watt	flusso/flux	CCT	Kg	colore/colour	codice/code
CIRCULAR SLIM Ø65					
50W 230V	6000lm	3000K	4	○ bianco/white	2004/SL/65/DIM/L/1/BI
				● oro p./p. gold	2004/SL/65/DIM/L/1/AU
				● rame/copper	2004/SL/65/DIM/L/1/CU

rosone / ceiling rose Ø23 H 5
alimentatori elettronici dimmerabili / electronic dimmable drivers

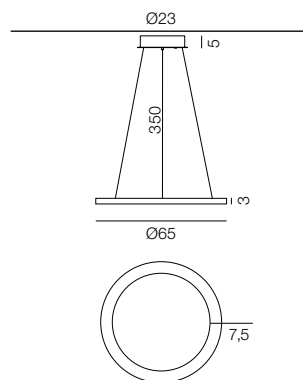
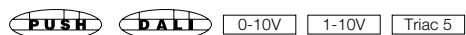

CIRCULAR SLIM Ø95					
75W 230V	9000lm	3000K	5	○ bianco/white	2004/SL/95/DIM/L/1/BI
				● oro p./p. gold	2004/SL/95/DIM/L/1/AU
				● rame/copper	2004/SL/95/DIM/L/1/CU

rosone / ceiling rose Ø23 H 5
alimentatori elettronici dimmerabili / electronic dimmable drivers

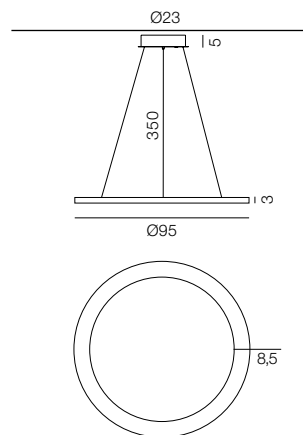
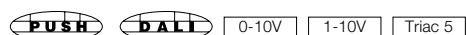

CIRCULAR SLIM Ø125					
112W 230V	13500lm	3000K	6	○ bianco/white	2004/SL/125/DIM/L/1/BI
				● oro p./p. gold	2004/SL/125/DIM/L/1/AU
				● rame/copper	2004/SL/125/DIM/L/1/CU

rosone / ceiling rose Ø23 H 5
alimentatori elettronici dimmerabili / electronic dimmable drivers

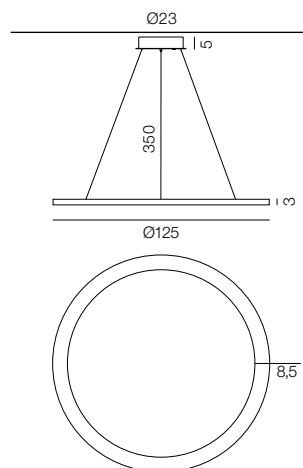
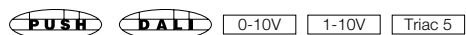

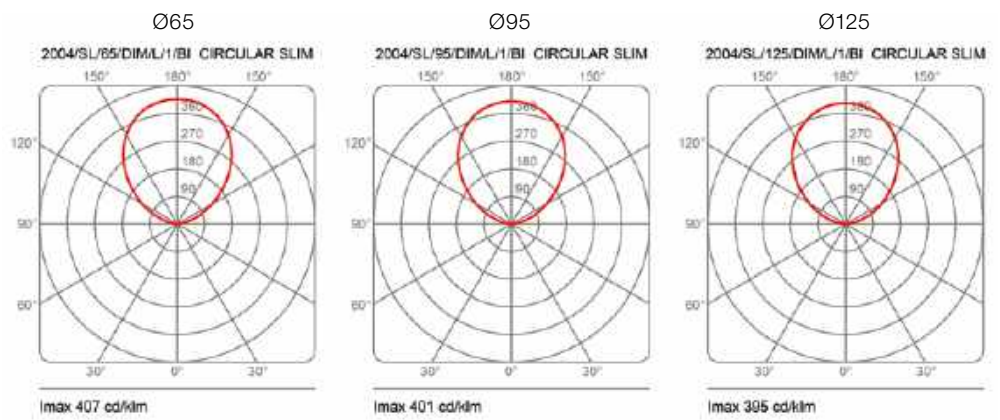

CIRCULAR SLIM

sospensione con faretti / suspension with spotlights



Un anello sospeso, a luce indiretta, supporta 4 o 8 spots a luce diretta orientabili, per sorgente di luce a LED. Struttura e faretti in alluminio verniciato nei colori, bianco, oro perlato e rame. Alimentatori elettronici dimmerabili inseriti all'interno del rosone al soffitto. Disponibile in due dimensioni.

A suspended ring with indirect light supporting 4 or 8 adjustable direct-light spotlights, for LED light source. Structure and spotlights in aluminium painted in white, pearly gold and copper colour. Electronic dimmable drivers inside the ceiling rose. Available in two sizes.



watt	fascio/beam	flusso/flux	CCT	Kg	colore/colour	codice/code
------	-------------	-------------	-----	----	---------------	-------------

CIRCULAR SLIM Ø95 - 4 SPOTS

indiretta / indirect

50W 230V 6000lm 3000K 5

+ spot

4x6W 230V narrow

2800lm

3000K

○ bianco/white

2004/SL/95/S/DIM/L/1/BI

● oro p./p. gold

2004/SL/95/S/DIM/L/1/AU

● rame/copper

2004/SL/95/S/DIM/L/1/CU

rosone / ceiling rose Ø31 H 6

alimentatori elettronici dimmerabili / electronic dimmable drivers



a richiesta con faretti 9w / on request with 9w spotlights

CIRCULAR SLIM Ø125 - 8 SPOTS

indiretta / indirect

67W 230V 10400lm 3000K 6

+ spot

8x6W 230V narrow

5600lm

3000K

○ bianco/white

2004/SL/125/S/DIM/L/1/BI

● oro p./p. gold

2004/SL/125/S/DIM/L/1/AU

● rame/copper

2004/SL/125/S/DIM/L/1/CU

rosone / ceiling rose Ø31 H 6

alimentatori elettronici dimmerabili / electronic dimmable drivers



a richiesta con faretti 9w / on request with 9w spotlights

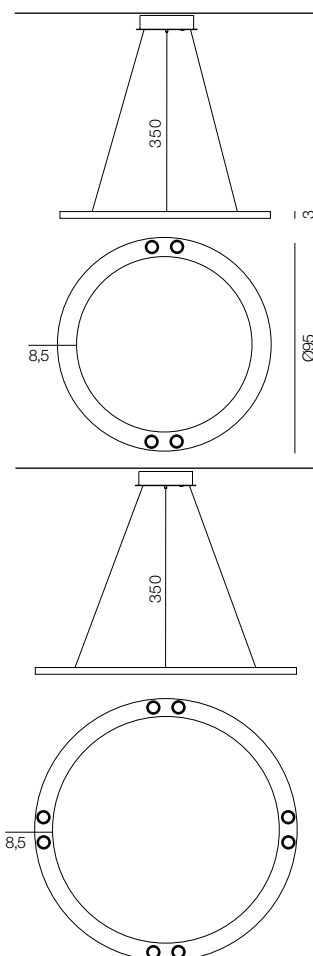

Ø95

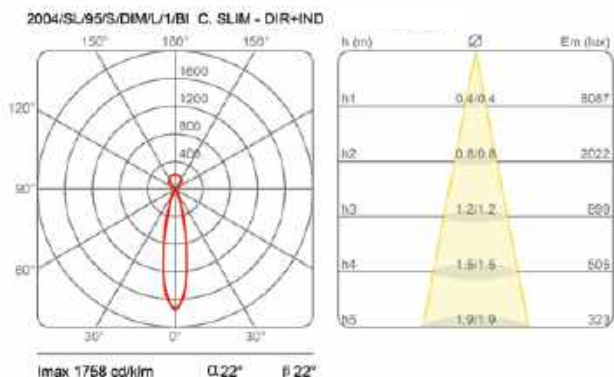





LUNA



Un disco luminoso in due diversi diametri scandisce lo spazio. La lampada è definita da una cornice in alluminio verniciato, da un grande diffusore e caratterizzata da un anello in metacrilato nel colore bianco, arancio o in alluminio.

A bright disc available in two different diameters articulates the space. The lamp is defined by a frame in lacquered aluminium, a large diffuser and it is characterized by a methacrylate ring available in white, orange or in aluminium.



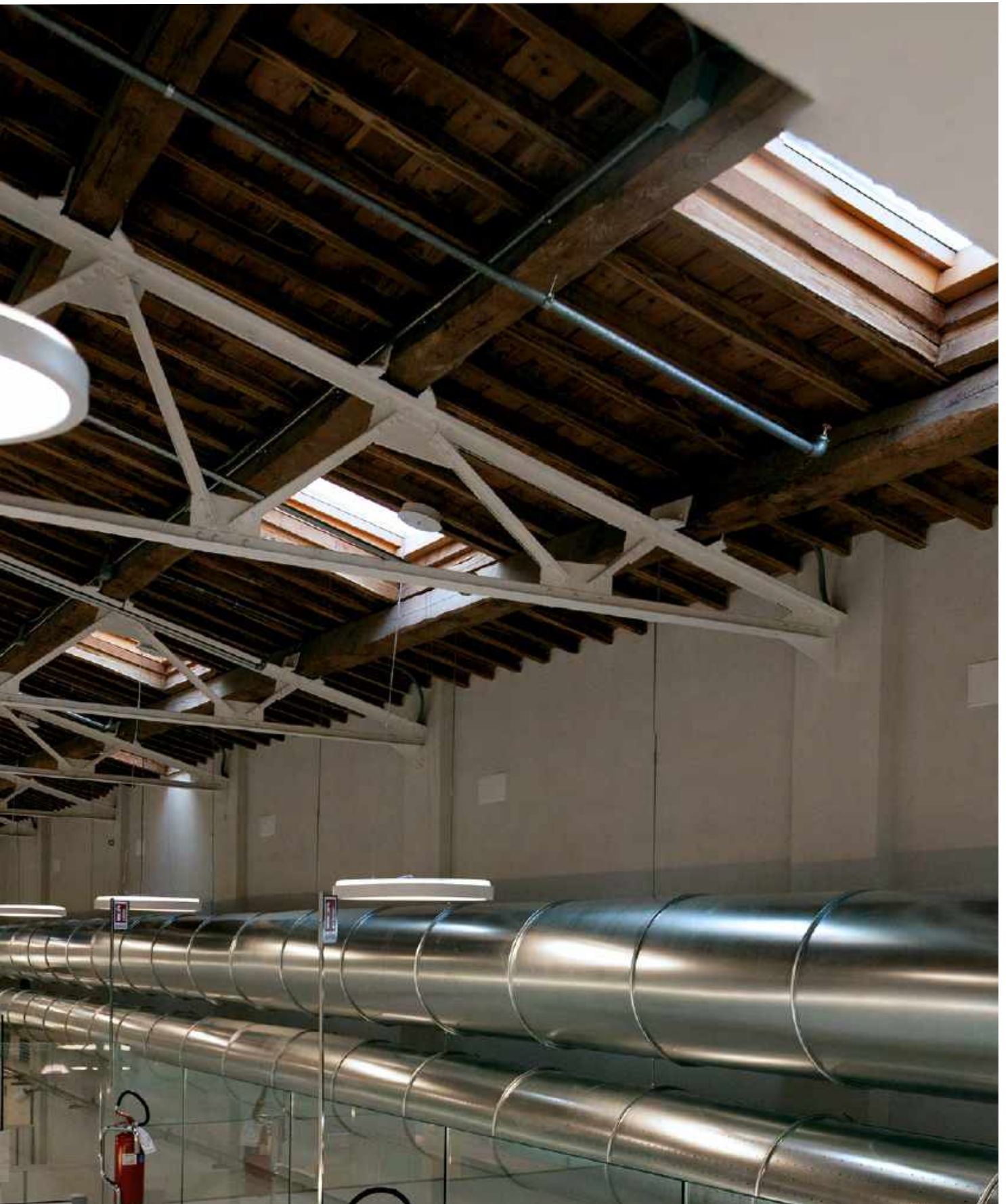





LUNA

sospensione / suspension lamp

Apparecchio a sospensione a luce diffusa.
Struttura in alluminio (B), anello superiore (A) in alluminio o in metacrilato nei colori bianco e arancio, diffusore (C) in metacrilato opal bianco (fig.1).

Sorgente di luce a LED integrata. Alimentatori elettronici dimmerabili nel rosone a soffitto.

Suspension device with diffused light.
Aluminium structure (B), aluminium or methacrylate superior ring (A) in white or orange colour, opal white methacrylate diffuser (C) (fig.1).

Integrated LED light source. Dimmable electronic drivers in the ceiling rose.



watt	flusso/flux	CCT	Kg	colore/colour	codice/code
LUNA Ø50	versione con anello superiore in metacrilato / with methacrylate upper ring version				
26W 230V	3000lm	3000K	6	<input type="radio"/> bianco-bianco/white-white <input type="radio"/> bianco-arancio/white-orange	2035/J/DIM/L/1/BI/BI 2035/J/DIM/L/1/BI/AR
LUNA Ø50	versione con anello superiore in alluminio / with aluminium upper ring version				
26W 230V	3000lm	3000K	6	<input type="radio"/> bianco/white	2035/J/DIM/L/1/BI

alimentatori elettronici dimmerabili / electronic dimmable drivers

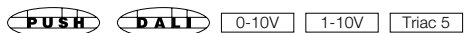

LUNA Ø80	versione con anello superiore in metacrilato / with methacrylate upper ring version				
79W 230V	9100lm	3000K	9	<input type="radio"/> bianco-bianco/white-white <input type="radio"/> bianco-arancio/white-orange	2035/M/DIM/L/1/BI/BI 2035/M/DIM/L/1/BI/AR
LUNA Ø80	versione con anello superiore in alluminio / with aluminium upper ring version				
79W 230V	9100lm	3000K	9	<input type="radio"/> bianco/white	2035/DIM/L/1/BI

alimentatori elettronici dimmerabili / electronic dimmable drivers

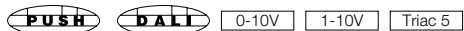

rosone al soffitto completo di alimentatore per luna Ø50 - Ø80

ceiling rose complete of ectronic driver for luna

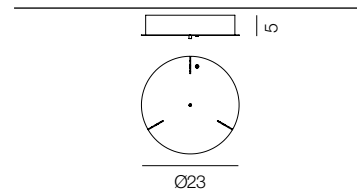
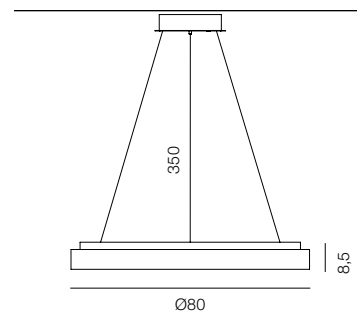
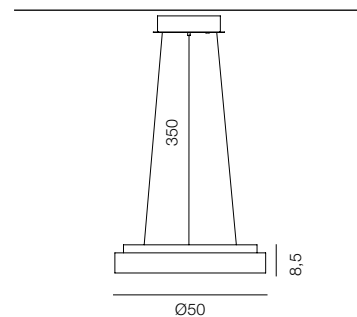
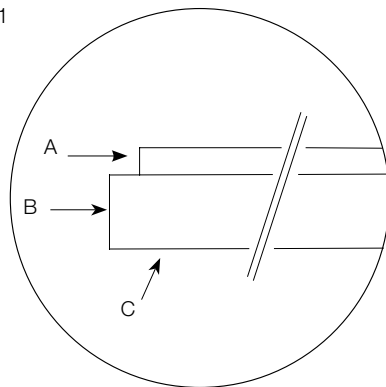
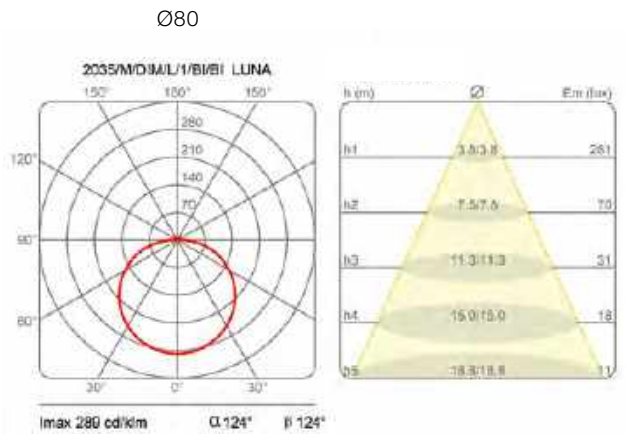



fig.1



- (A) Anello superiore in alluminio verniciato bianco o in metacrilato nei colori bianco o arancio
White painted aluminium or methacrylate superior ring in white or orange colour
- (B) Struttura in alluminio
Aluminium structure
- (C) Diffusore in metacrilato opal bianco
White opal metacrylate diffuser



LUNA

soffitto / ceiling

Lampada da soffitto a luce diffusa. Struttura in alluminio, anello superiore in alluminio o in metacrilato nei colori bianco o arancio, diffusore in metacrilato opal bianco.
Sorgente di luce a LED integrata.
Completo di alimentatori elettronici dimmerabili.

Ceiling lamp diffused light. Aluminium structure, aluminium or methacrylate superior ring in white or orange colour, white opal methacrylate diffuser, ring diffuser.
Integrated LED light source.
Complete of dimmable electronic drivers.



watt	flusso/flux	CCT	Kg	colore/colour	codice/code
LUNA Ø50 con anello superiore in metacrilato / methacrylate upper ring version					
26W 230V	3000lm	3000K	6	<input type="radio"/> bianco-bianco/white-white <input checked="" type="radio"/> bianco-arancio/white-orange	2862/J/DIM/L/1/BI/BI 2862/J/DIM/L/1/BI/AR
LUNA Ø50 con anello superiore in alluminio / aluminium upper ring version					
26W 230V	3000lm	3000K	6	<input type="radio"/> bianco/white	2862/J/DIM/L/1/BI

alimentatori elettronici dimmerabili / electronic dimmable drivers

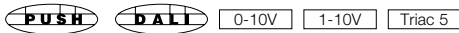

LUNA Ø80 con anello superiore in metacrilato / methacrylate upper ring version					
79W 230V	9100lm	3000K	9	<input type="radio"/> bianco-bianco/white-white <input checked="" type="radio"/> bianco-arancio/white-orange	2862/M/DIM/L/1/BI/BI 2862/M/DIM/L/1/BI/AR
LUNA Ø80 con anello superiore in alluminio / aluminium upper ring version					
79W 230V	9100lm	3000K	9	<input type="radio"/> bianco/white	2862/DIM/L/1/BI

alimentatori elettronici dimmerabili / electronic dimmable drivers

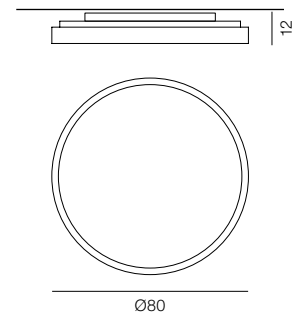
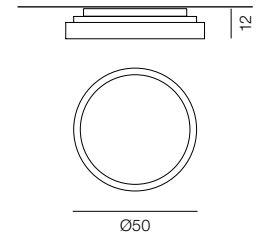
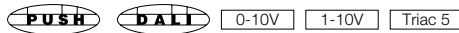



Banca di Cavola e Sassuolo, Reggio Nell'Emilia - arch. Roberto Iori



MAMBA

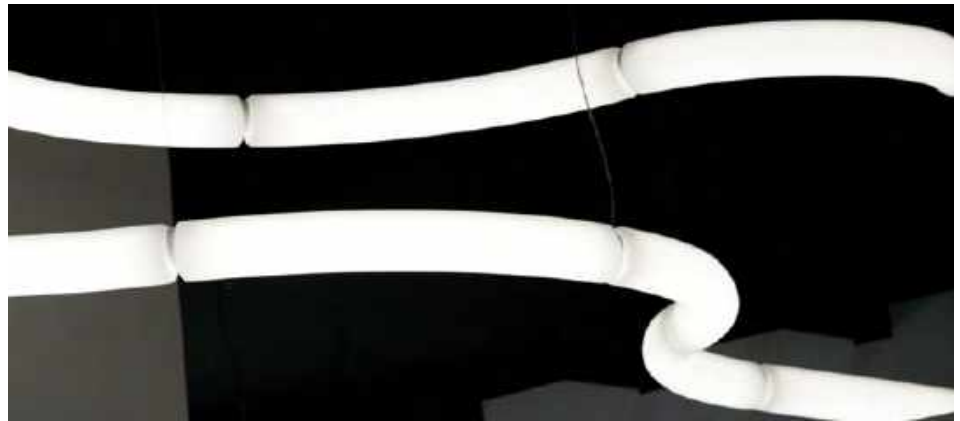

Una presenza discreta e leggera che con moduli componibili stampati con la tecnologia rotazionale, in polietilene, curvi, ad angolo e lineari delimita, caratterizza e illumina, un percorso, un'architettura, spazi commerciali e privati.

A discrete, lightweight presence that, with its rotational-molding technology of modular components in polyethylene, curved, angular and linear, defines, characterizes and illuminates an architectural space, commercial and private settings.





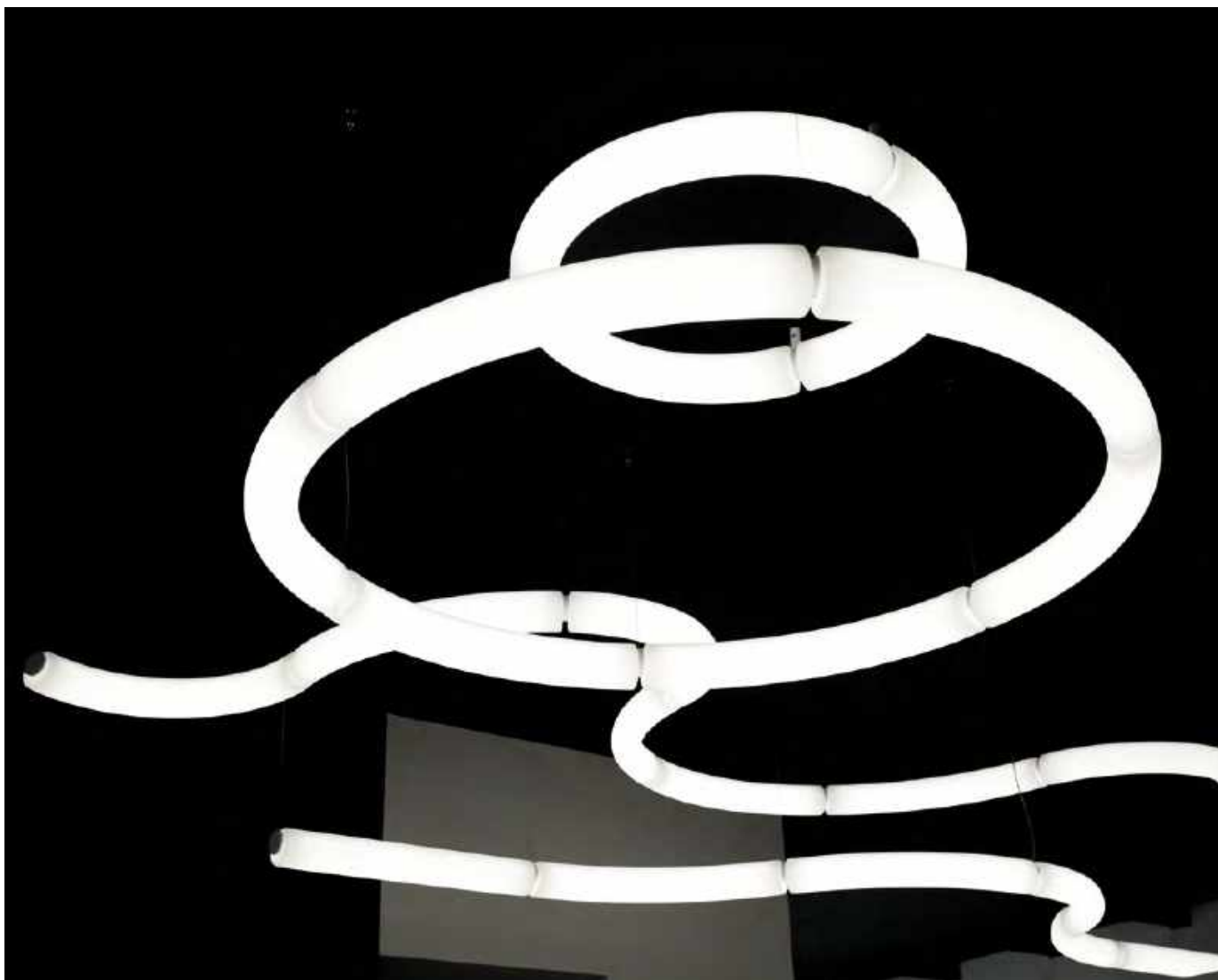



















MAMBA

moduli / modules

Sistema componibile a luce diffusa, formato da moduli e giunti per il collegamento.
Struttura in polietilene, stampata con la tecnologia rotazionale.
Sorgente di luce a LED integrata.
Da collegare all'alimentatore elettronico dimmerabile inserito nel controsoffitto, remoto o all'interno del rosone al soffitto.

Modular system with diffused light, composed of modules and joints. Polyethylene structure, printed with rotational molding technology.
Integrated LED light source.
The modules must be connected to the dimmable electronic driver, which can be placed inside the ceiling rose, the false ceiling or remotely.



watt	flusso/flux	CCT	Kg	colore/colour	codice/code
MODULO CURVO / CURVED MODULE 30°					
25W 24V	3000lm	2700K	1,5	○ bianco/white	40135/2700/BI
		3000K		○ bianco/white	40135/BI
		4000K		○ bianco/white	40135/4000/BI
MODULO CURVO / CURVED MODULE 60°					
25W 24V	3000lm	2700K	1,5	○ bianco/white	40020/2700/BI
		3000K		○ bianco/white	40020/BI
		4000K		○ bianco/white	40020/4000/BI
MODULO CURVO / CURVED MODULE 90°					
12,5W 24V	1500lm	2700K	1	○ bianco/white	40053/2700/BI
		3000K		○ bianco/white	40053/BI
		4000K		○ bianco/white	40053/4000/BI
MODULO CURVO / CURVED MODULE 120°					
25W 24V	3000lm	2700K	1,5	○ bianco/white	40021/2700/BI
		3000K		○ bianco/white	40021/BI
		4000K		○ bianco/white	40021/4000/BI
MODULO LINEARE / LINEAR MODULE					
25W 24V	3000lm	2700K	1,5	○ bianco/white	40022/2700/BI
		3000K		○ bianco/white	40022/BI
		4000K		○ bianco/white	40022/4000/BI

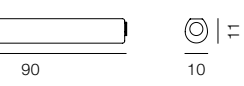
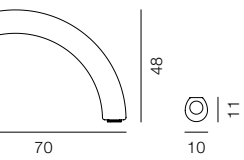
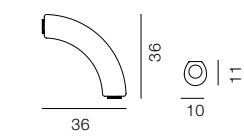
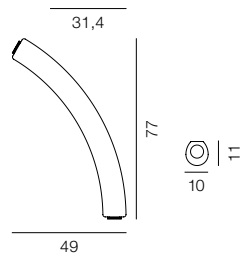
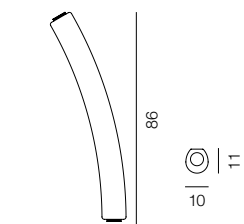



GIUNTI DI COLLEGAMENTO TRA MODULI / CONNECTION JOINTS BETWEEN MODULES

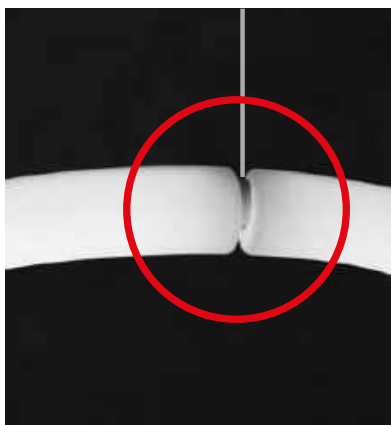

KIT DI SOSPENSIONE / SUSPENSION KIT

- A) giunto intermedio con cavo di sospensione / intermediate joint with hanging cable 40026/BI
- B) testata terminale con cavo di sospensione / terminal head with hanging cable 40027/BI
- connettore elettrico tra moduli / electronic connection for modules 40028/BI

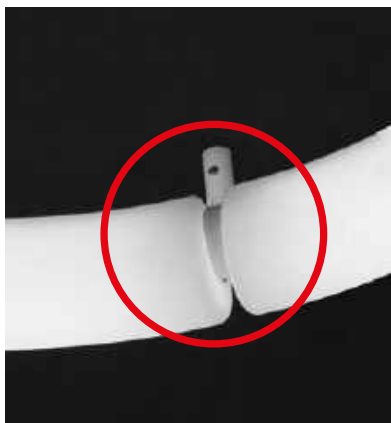
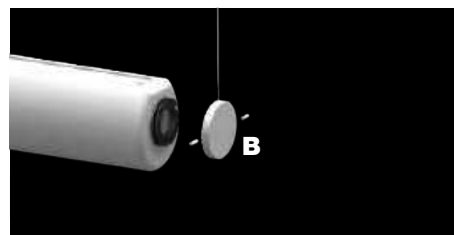
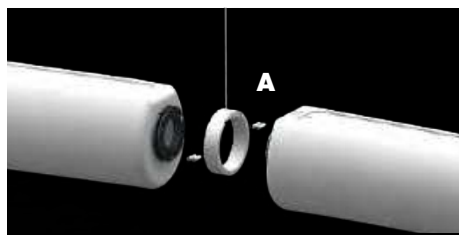

KIT SOFFITTO O PARETE / CEILING OR WALL KIT

- C) giunto intermedio con supporto / intermediate joint with support 40047/BI
- D) testata terminale con supporto / terminal head with support 40048/BI
- connettore elettrico tra moduli / electronic connection for modules 40028/BI

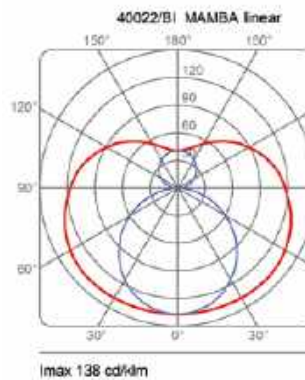
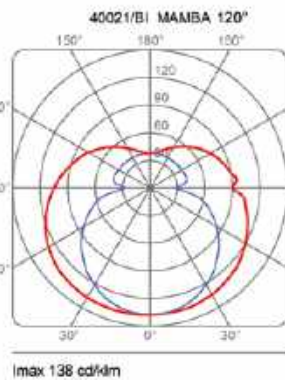
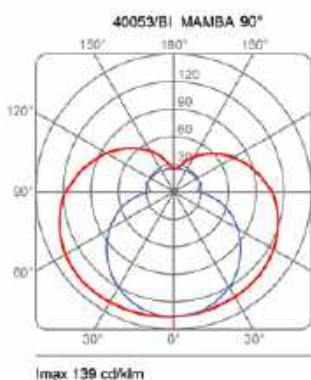
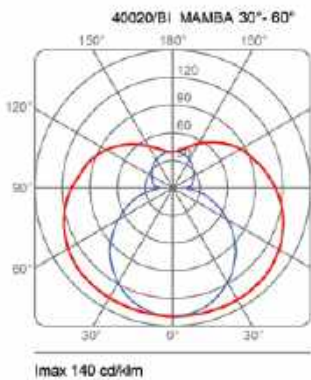
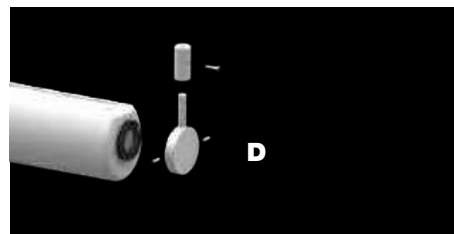
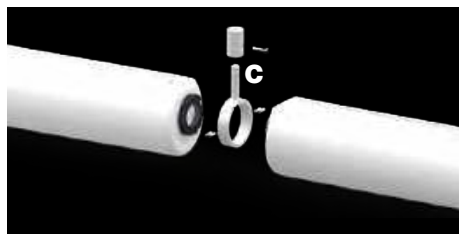

MAMBA

rosoni / ceiling roses

Rosoni completi di alimentatore elettronico da inserire nel controsoffitto, in remoto o da fissare al soffitto per le composizioni a sospensione. In alluminio verniciato nel colore bianco.

Ceiling roses complete with electronic driver to be placed in the false ceiling, to be used remotely or fixed to the ceiling for pendant compositions. In white-lacquered aluminium.



NON DIMMERABILE / NON DIMMABLE

DIMMERABILE / DIMMABLE

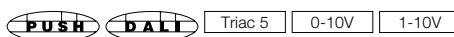

watt colore/colour codice/code

kit alimentatore remoto max 6 moduli
remote driver kit for linear and sinuous paths

150W 230/24V ○ bianco/white 40025/BI

rosone per anello / ceiling rose for ring Ø70

75W 230/24V ○ bianco/white 40124/BI

rosone per anello / ceiling rose for ring Ø95

75W 230/24V ○ bianco/white 40023/BI

rosone per anello / ceiling rose for ring Ø180

150W 230/24V ○ bianco/white 40024/BI

rosone per anello / ceiling rose for ring Ø352

300W 230/24V ○ bianco/white 40147/BI

rosoni per versione quadrata, ovale e lineare
ceiling roses for square, oval and linear versions

75W 230/24V ○ bianco/white 40023.1/BI

150W 230/24V ○ bianco/white 40024.1/BI

300W 230/24V ○ bianco/white 40147.1/BI

watt colore/colour codice/code

kit alimentatore remoto max 6 moduli
remote driver kit for linear and sinuous paths

150W 230/24V ○ bianco/white 40025/DIM/BI

rosone per anello / ceiling rose for ring Ø70

75W 230/24V ○ bianco/white 40124/DIM/BI

rosone per anello / ceiling rose for ring Ø95

75W 230/24V ○ bianco/white 40023/DIM/BI

rosone per anello / ceiling rose for ring Ø180

150W 230/24V ○ bianco/white 40024/DIM/BI

rosone per anello / ceiling rose for ring Ø352

300W 230/24V ○ bianco/white 40147/DIM/BI

rosoni per versione quadrata, ovale e lineare
ceiling roses for square, oval and linear versions

75W 230/24V ○ bianco/white 40023.1/DIM/BI

150W 230/24V ○ bianco/white 40024.1/DIM/BI

300W 230/24V ○ bianco/white 40147.1/DIM/BI

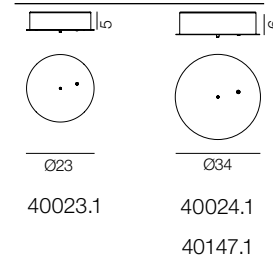
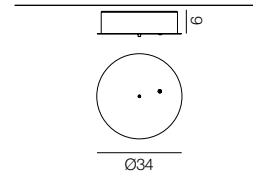
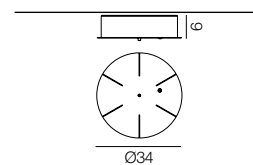
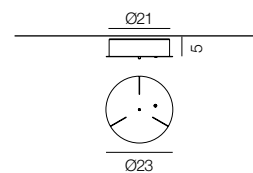
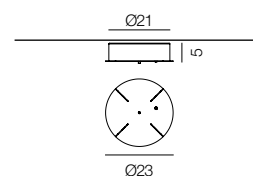
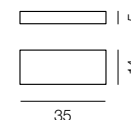

cavi di sospensione 350 cm
350 cm suspension cable

La scelta del codice del rosone nelle diverse composizioni è legato alla somma dei Watt dei singoli anelli ed al tipo di dimmerazione.

The choice of the ceiling rose in the different composition code is related to the sum of the watts of the different rings and the type of dimmeration.

MAMBA

esempi di composizione a sospensione / examples of suspension lamp compositions

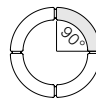

ANELLO / RING Ø70:
4 moduli/modules 90° 40053/BI
1 rosone/ceiling rose 40124/BI-40124/DIM/BI
4 giunti intermedi/intermediate joints 40026/BI
3 connettori elettr./ electr. connectors 40028/BI

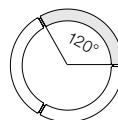

ANELLO / RING Ø95:
3 moduli/modules 120° 40021/BI
1 rosone/ceiling rose 40023/BI-40023/DIM/BI
3 giunti intermedi/intermediate joints 40026/BI
2 connettori elettr./ electr. connectors 40028/BI

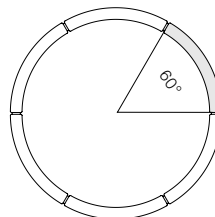
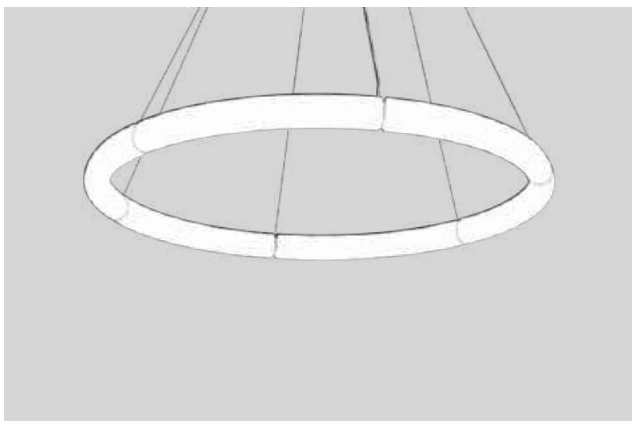

ANELLO / RING Ø180:
6 moduli/modules 60° 40020/BI
1 rosone/ceiling rose 40024/BI-40024/DIM/BI
6 giunti intermedi/intermediate joints 40026/BI
5 connettori elettr./ electr. connectors 40028/BI

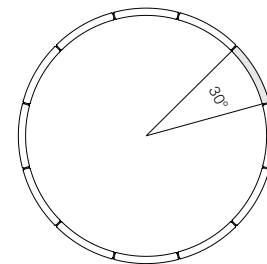
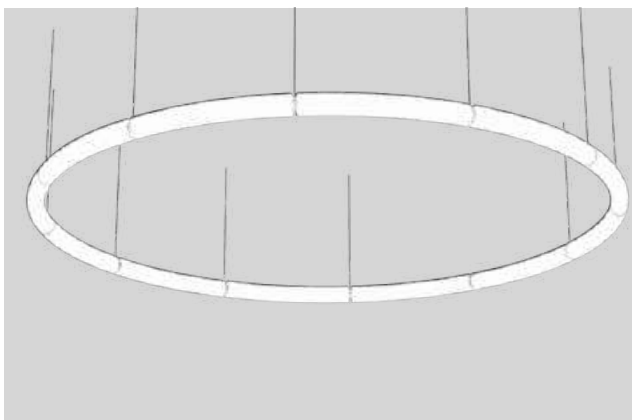

ANELLO / RING Ø352:
12 moduli/modules 30° 40135/BI
1 rosone/ceiling rose 40147/BI - 40147/DIM/BI
12 giunti intermedi/intermediate joints 40026/BI
11 connettori elettr./ electr. connectors 40028/BI

MAMBA

esempi di composizione a sospensione / examples of suspension lamp compositions

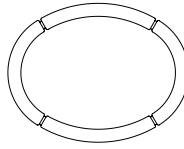
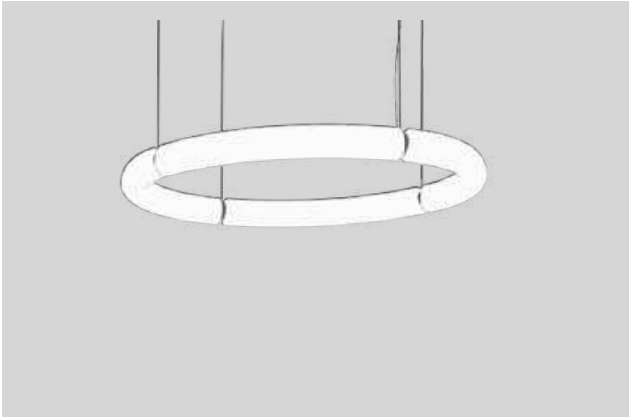

OVALE / OVAL 140x107
2 moduli/modules 60° 40020/BI
2 moduli/modules 120° 40021/BI
1 rosone/ceiling rose 40024.1/BI
4 giunti intermedi/intermediate joints 40026/BI
3 connettori elettr./ electr. connectors 40028/BI

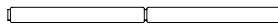
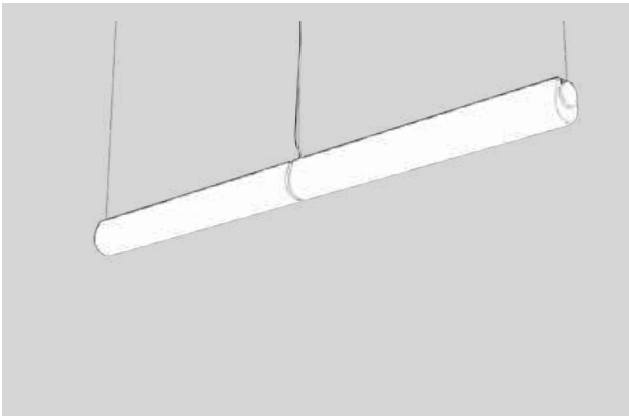

LINEARE / LINEAR
2 moduli/modules 40022/BI
1 rosone/ceiling rose 40124.1/BI
1 giunto intermedio/intermediate joint 40026/BI
2 giunti terminali/ terminal joints
1 connettori elettr./ electr. connectors 40028/BI

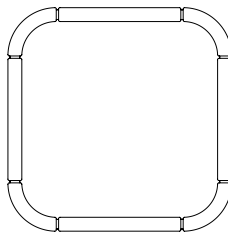
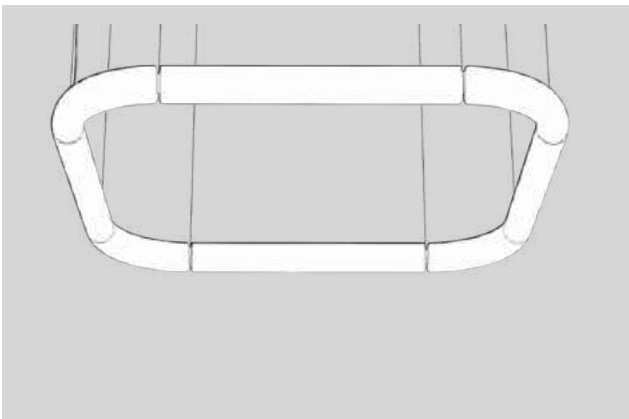

QUADRATO / SQUARE 161x161
4 moduli/modules 90° 40053/BI
4 moduli/modules 40022/BI
1 rosone/ceiling rose 40024.1/BI-40025
8 giunti intermedi/intermediate joints 40026/BI
7 connettori elettr./ electr. connectors 40028/BI

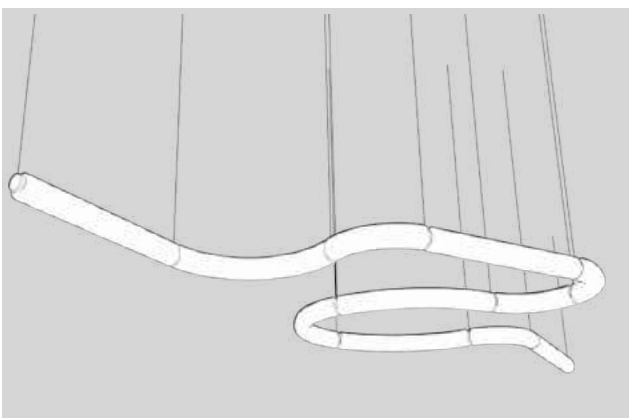

SINUOSO / SINUOUS
composizione libera/free composition



MAMBA

parete ad angolo / wall corner

Lampada da parete a luce diffusa, struttura in polietilene.
Formata dal modulo a 90° del sistema e da due attacchi laterali in alluminio verniciato, per il fissaggio all'angolo tra due pareti.
Sorgente di luce a LED integrata.
Alimentatore elettronico dimmerabile remoto.

Diffused light wall lamp, in polyethylene structure.
Composed of a 90° system module, with two side aluminium painted joints, suitable for corner placement.
Integrated LED light source.
Remote dimmable electronic driver.

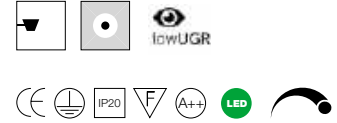

watt	flusso/flux	CCT	Kg	colore/colour	codice/code
------	-------------	-----	----	---------------	-------------

MODULO CURVO / CURVED MODULE 90°

12,5W 24V	1500lm	2700K	1,5	○ bianco/white	1439/2700/BI
		3000K		○ bianco/white	1439/BI
		4000K		○ bianco/white	1439/4000/BI

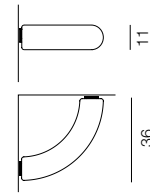

alimentatori elettronici dimmerabili remoti 230/24V / remote electronic dimmable drivers 230/24V

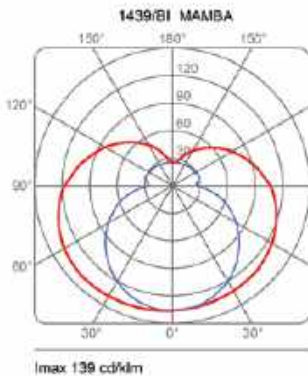
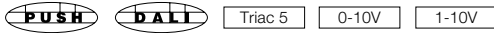





CIRCULAR POL



Una serie di anelli di luce di diverso diametro sospesi per illuminare ampi spazi architettonici. Con un grande foro centrale, in gruppo o solitari, definiscono un luogo senza interrompere la visuale.

A series of pendant multi-diameter rings of light to illuminate large architectural spaces. With a large central hole, whether in a group or alone, they define an environment without interrupting the view.





Centro Commerciale Jubilee Mall, Sud Africa

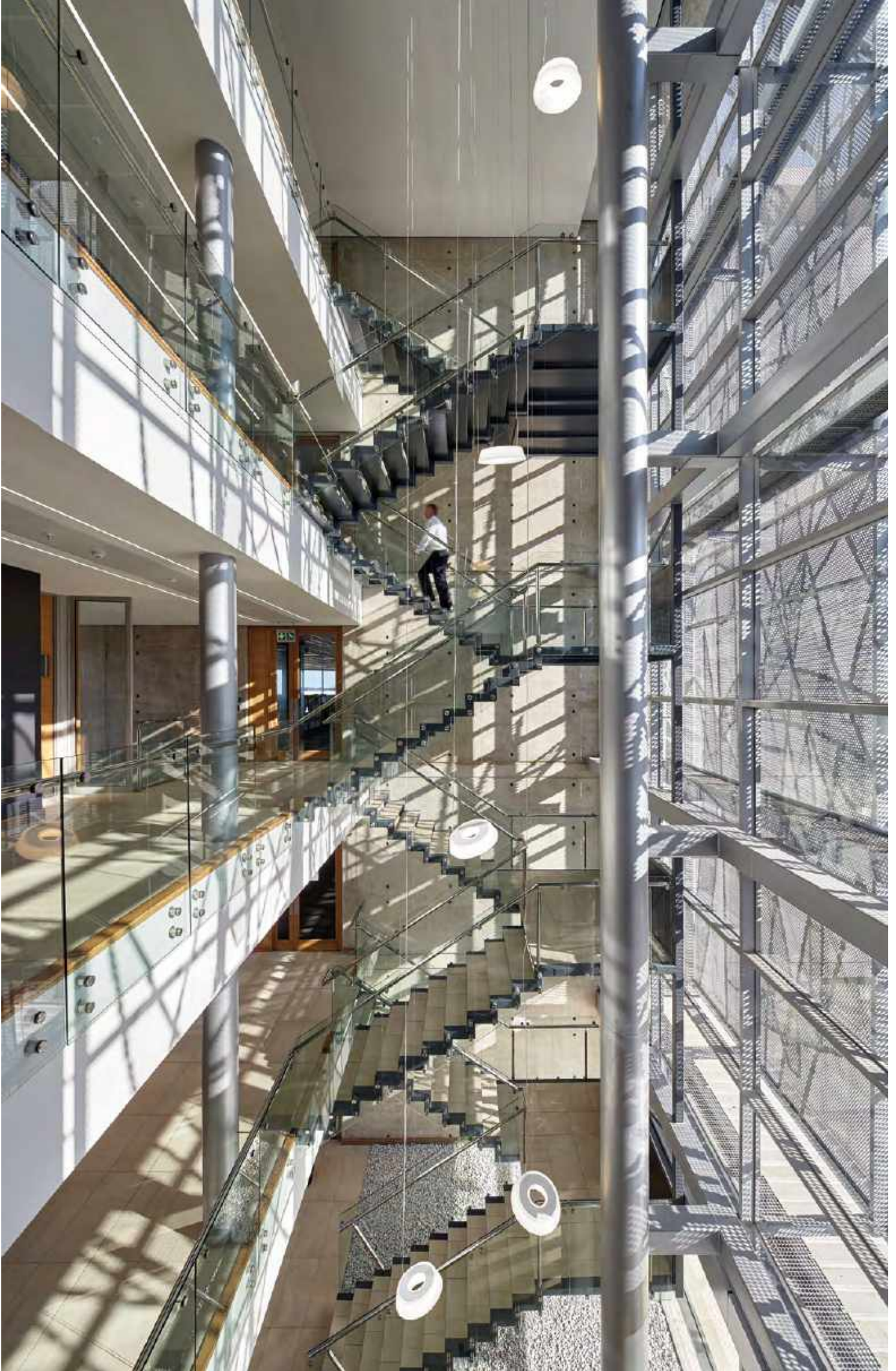



Centro Commerciale Coop, Orvieto – Studio Inres

CIRCULAR POL

sospensione / suspension lamp



Lampada a sospensione a luce diffusa.
Struttura in polietilene bianco stampato con la tecnologia rotazionale.
Sorgente di luce a LED integrata.
Completa di alimentatori elettronici dimmerabili fissati all'interno del rosone a soffitto.
Disponibile in tre diversi diametri.

Suspension lamp, diffused light.
White polyethylene structure printed with rotational molding technology.
Integrated LED light source.
Complete with electronic dimmable drivers placed inside the ceiling rose.
Available in three different diameters.



watt	flusso/flux	CCT	Kg	colore/colour	codice/code
------	-------------	-----	----	---------------	-------------

CIRCULAR POL Ø52

26W 230V	3200lm	3000K	3,5	○ bianco/white	2057/XS/DIM/L/1/BI
----------	--------	-------	-----	----------------	--------------------

rosone / ceiling rose Ø22 H 5

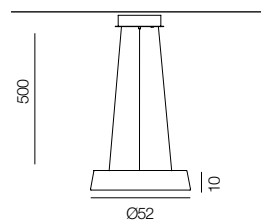

CIRCULAR POL Ø90

60W 230V	6750lm	3000K	8	○ bianco/white	2057/J/DIM/L/1/BI
----------	--------	-------	---	----------------	-------------------

rosone / ceiling rose Ø22 H 5

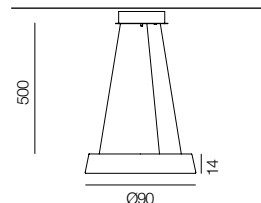

CIRCULAR POL Ø150

105W 230V	10000lm	3000K	20	○ bianco/white	2057/DIM/L/1/BI
-----------	---------	-------	----	----------------	-----------------

rosone / ceiling rose Ø26 H 5

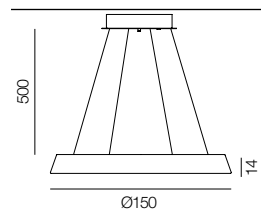

alimentatori elettronici dimmerabili integrati / integrated electronic dimmable drivers



Ø52

Ø90

Ø150



lmax 196 cd/klm α 133° β 133°



lmax 199 cd/klm α 137° β 137°

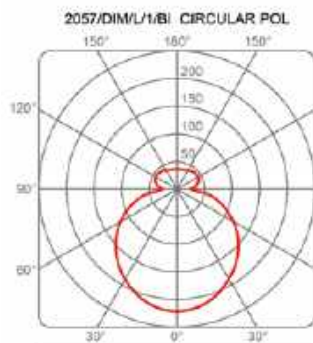

lmax 222 cd/klm α 126° β 126°



CIRCULAR POL

parete-soffitto / wall-ceiling

Lampada da soffitto/parete a luce diffusa.
Struttura in polietilene bianco stampato con la tecnologia rotazionale. Base in alluminio verniciato.
Sorgente di luce a LED integrata.
Completa di alimentatore elettronico dimmerabile all'interno del corpo lampada.

Ceiling/wall lamp, diffused light.
White polyethylene structure printed with rotational molding technology. Painted aluminium base.
Integrated LED light source.
Complete with electronic dimmable driver inside the body lamp.

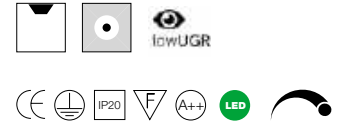

watt	flusso/flux	CCT	Kg	colore/colour	codice/code
CIRCULAR POL					
26W 230V	3200lm	3000K	3,5	○ bianco/white	2878/DIM/L/1/BI

alimentatori elettronici dimmerabili integrati / integrated electronic dimmable drivers

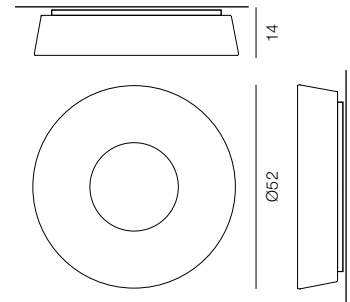

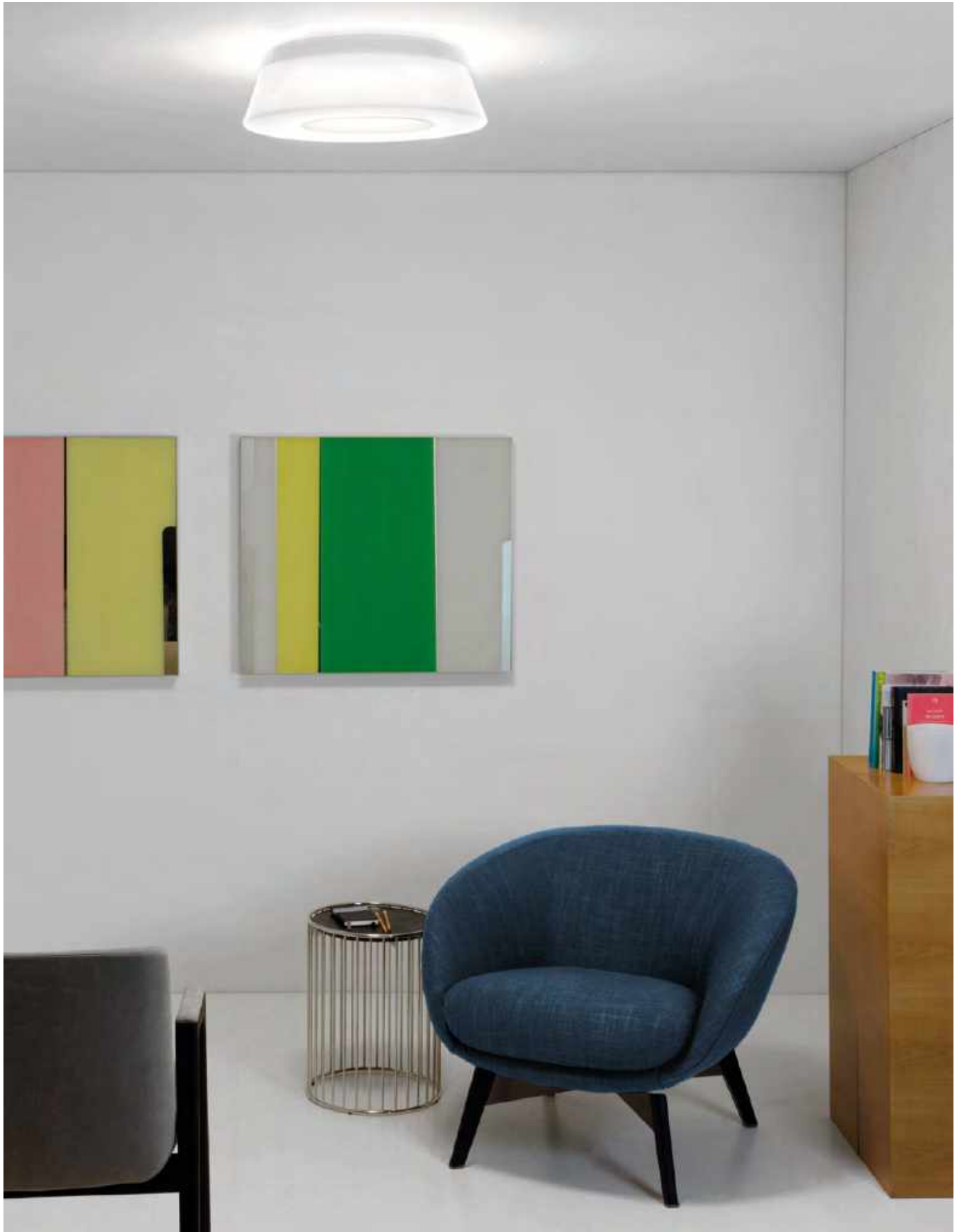



CIRCULAR POL XXL



Sistema di lampade a sospensione componibili a luce diffusa che comprende moduli lineari, curvi ed angolari. La combinazione dei moduli consente di creare percorsi sinuosi e lineari di varia lunghezza in modo da seguire l'andamento dell'architettura, o formare anelli di diverso diametro, descrivere quadrati o dare vita a configurazioni più complesse. I moduli, collegati e distanziati tra di loro da un particolare giunto in metallo completo di cavo in acciaio per la sospensione, evidenziano e caratterizzano la composizione che si viene a creare, in base ad ogni singolo progetto.

A system with fitted suspension lamps and diffused light which includes linear, curved and regular modules.

By combining the modules it is possible to create sinuous and linear paths with different lengths in order to follow the architecture trend or to set up rings with different diameters, to describe squares or to create more complex configurations.

The modules, connected and spaced out by a special metal joint equipped with steel cables for the suspension, emphasize and distinguish the composition that is created, depending on each project.





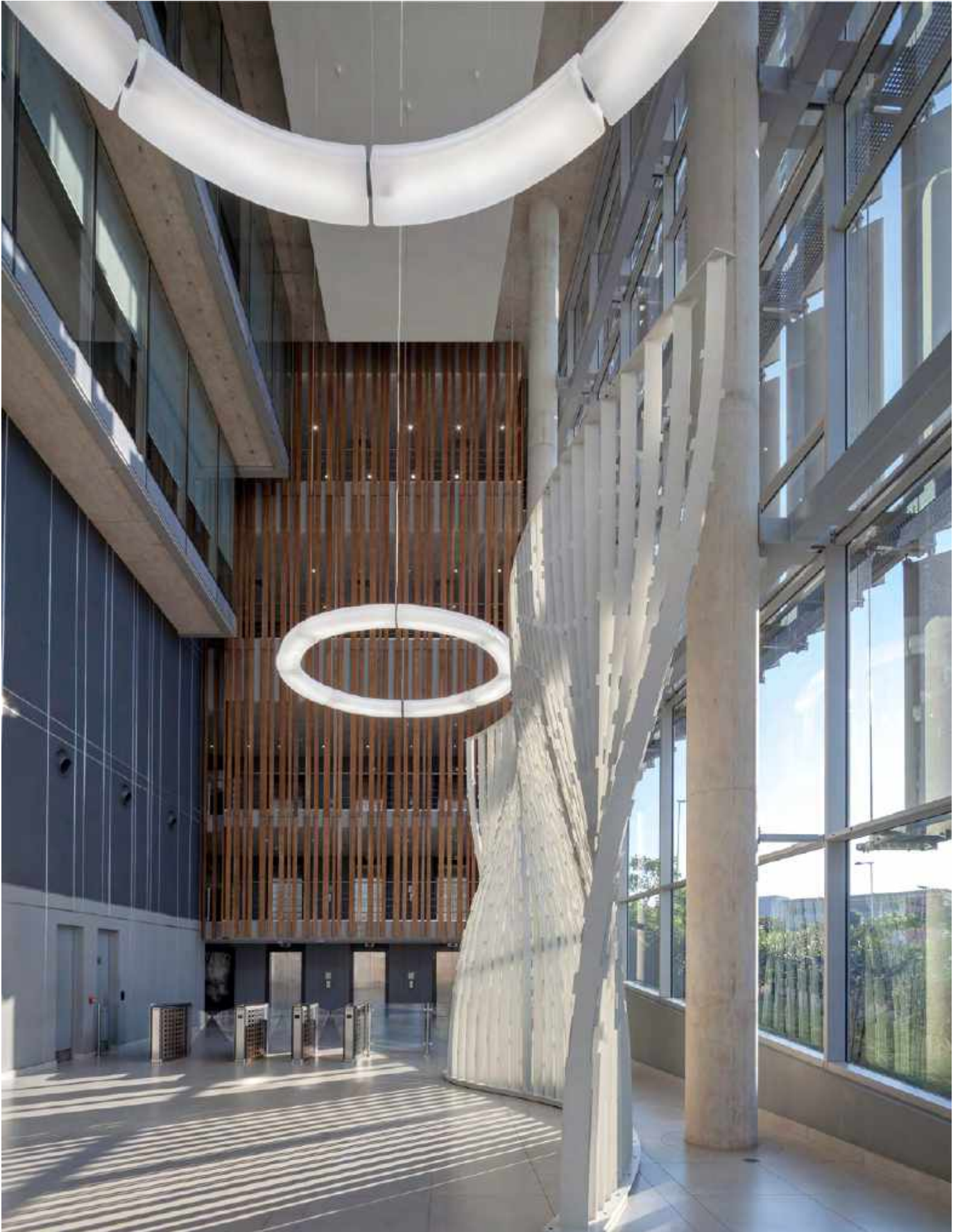

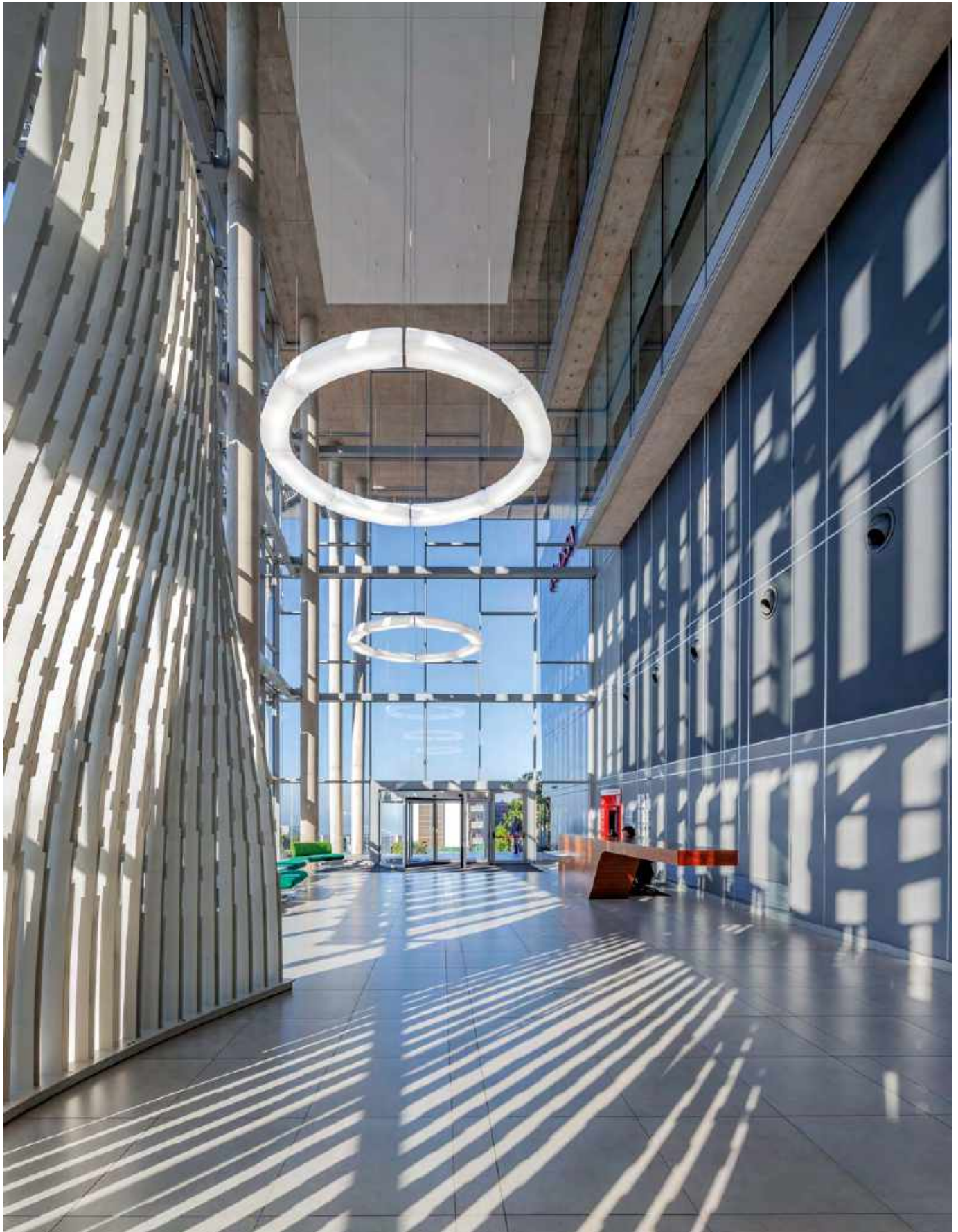





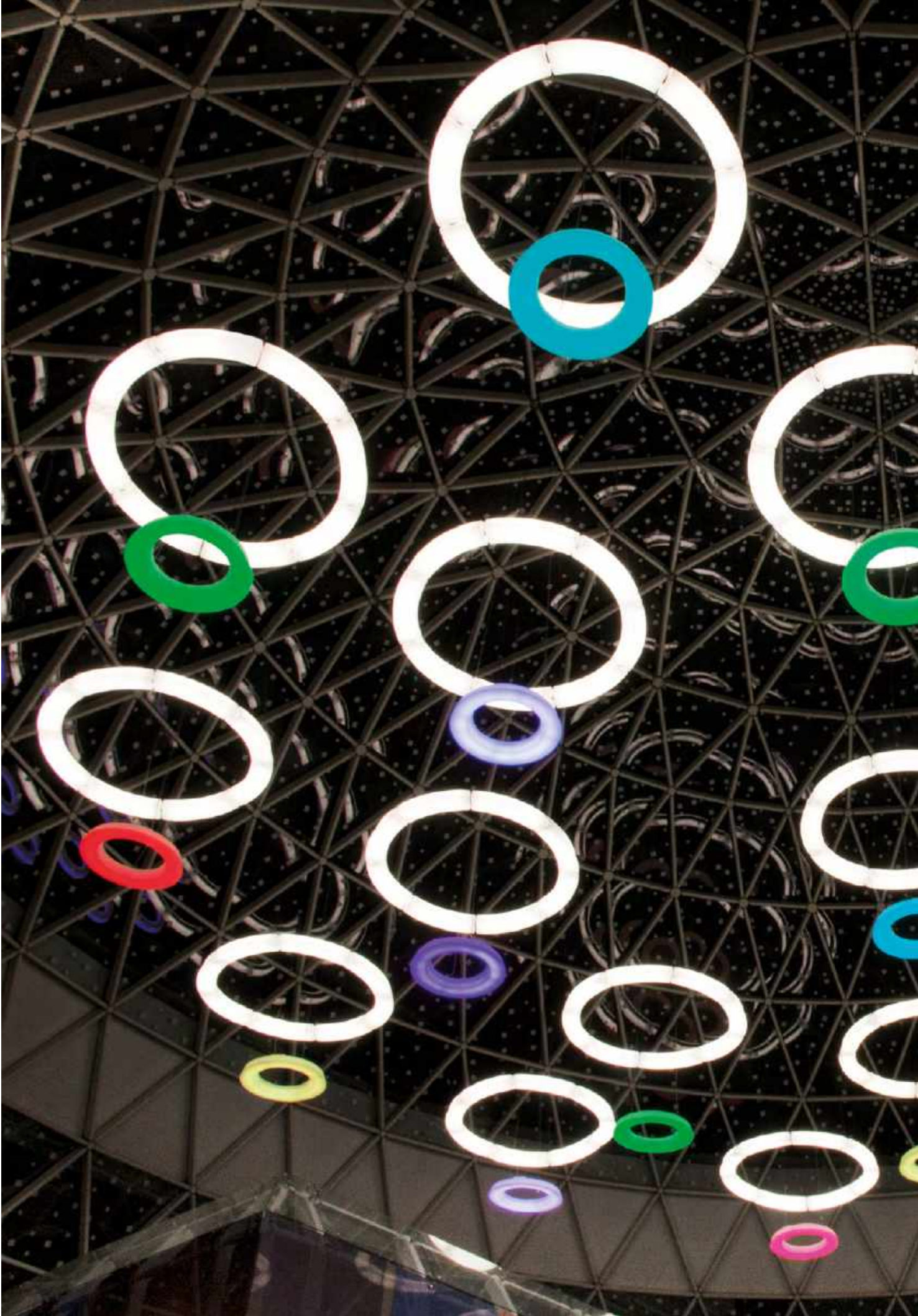

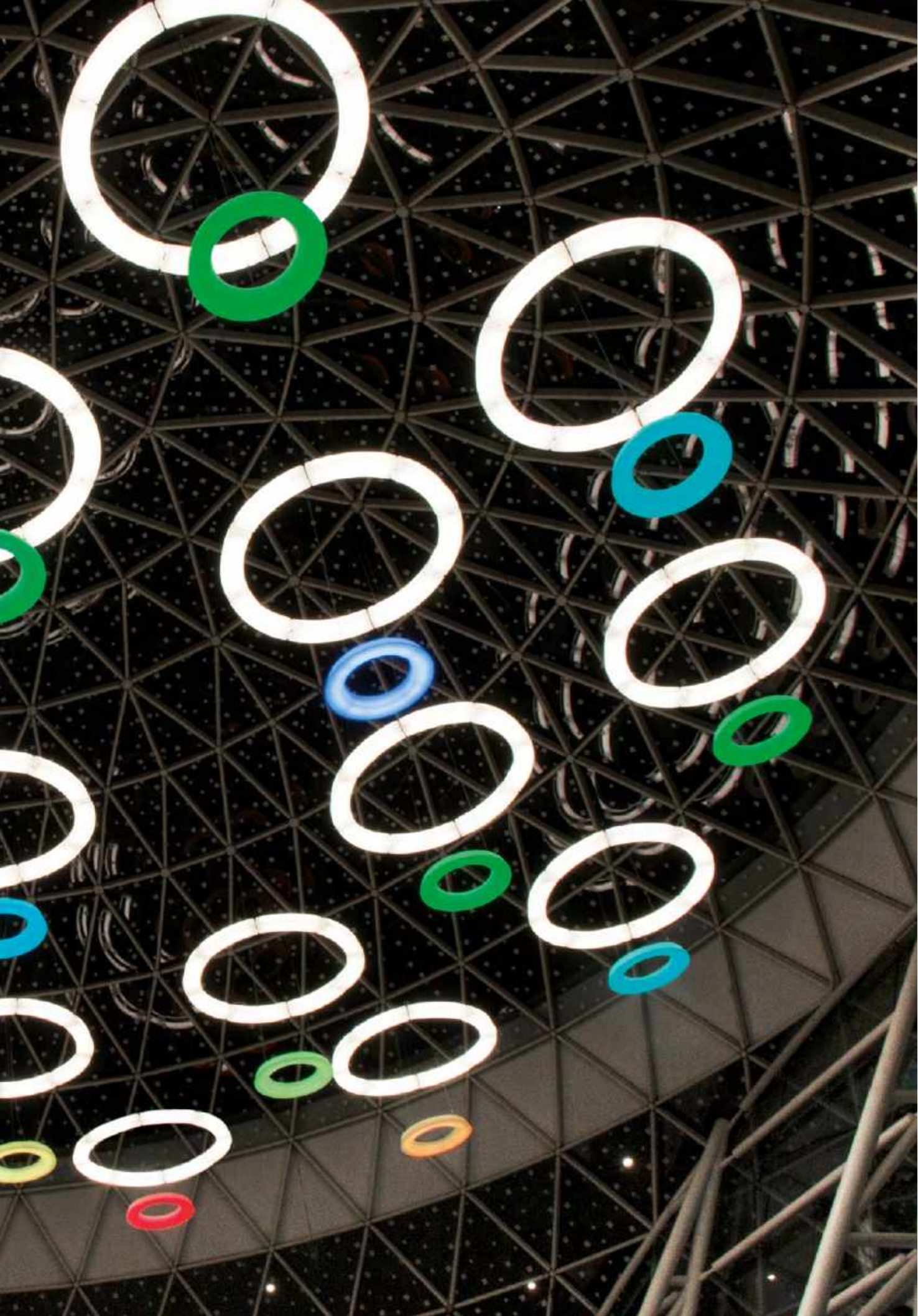





CIRCULAR POL XXL

moduli / modules

Sistema componibile a luce diffusa con moduli lineari, angolari e curvi da combinare per comporre varie configurazioni. Sospesi con cavi in acciaio, stampati in rotazionale, materiale polietilene e con giunti in alluminio per il collegamento dei moduli.

Sorgente di luce a LED integrata. Alimentatori elettronici dimmerabili all'interno dei moduli.

Modular system, diffused light: angular, linear, curved modular lighting device for different configurations. Suspended with steel cables, printed with rotational molding technology with polyethylene material, aluminium joints for connecting the modules.

Integrated LED light source. Dimmable electronic drivers inside the modules.



watt	flusso/flux	CCT	Kg	colore/colour	codice/code
------	-------------	-----	----	---------------	-------------

MODULO LINEARE / LINEAR MODULE

60W 230V	6750lm	3000K	8	○ bianco/white	40828/L/1/BI
----------	--------	-------	---	----------------	--------------

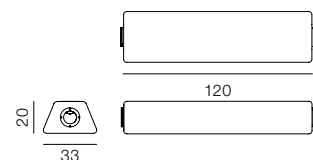

MODULO CURVO 45° / CURVED MODULE 45°

60W 230V	6750lm	3000K	8	○ bianco/white	40829/L/1/BI
----------	--------	-------	---	----------------	--------------

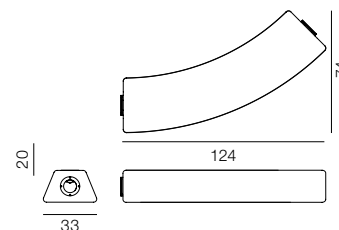

MODULO ANGOLARE 90° / ANGULAR MODULE 90°

20W 230V	2250lm	3000K	4	○ bianco/white	40854/L/1/BI
----------	--------	-------	---	----------------	--------------

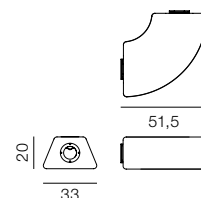

alimentatori elettronici dimmerabili integrati / integrated electronic dimmable drivers



LINEARE / LINEAR

40828/L/1/BI CIRCULAR POL XXL

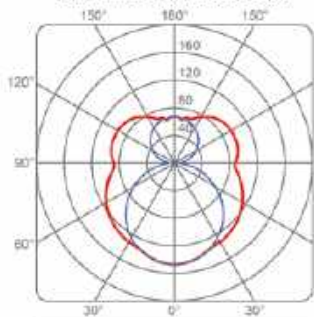

Imax 147 cd/m²

45°

40829/L/1/BI CIRCULAR POL XXL

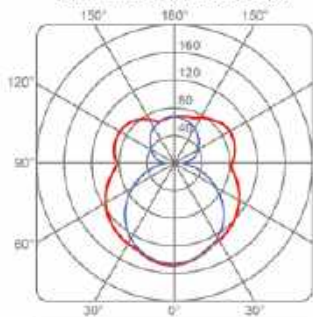

Imax 149 cd/m²

90°

40854/L/1/BI CIRCULAR POL XXL

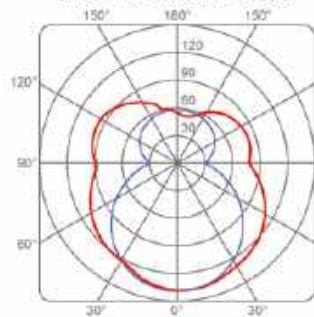

Imax 139 cd/m²



GIUNTI DI COLLEGAMENTO TRA MODULI / CONNECTION JOINTS BETWEEN MODULES

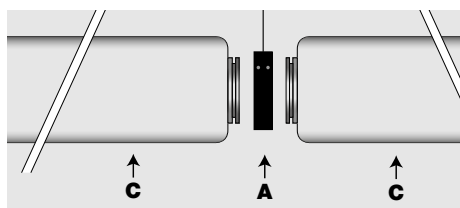

- A) giunto intermedio con cavo di sospensione in acciaio.
intermediate joint with suspension cable in steel.

40831/GR

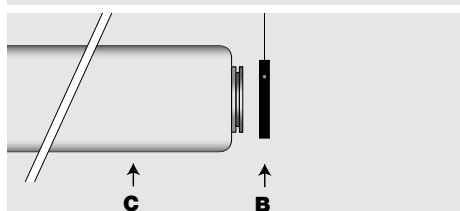

- B) testata terminale con cavo di sospensione in acciaio.
closing head cover with steel suspension cable.

40830/GR

- C) modulo diffusore lineare, curvo o angolare.
curved, linear or angular module diffuser.

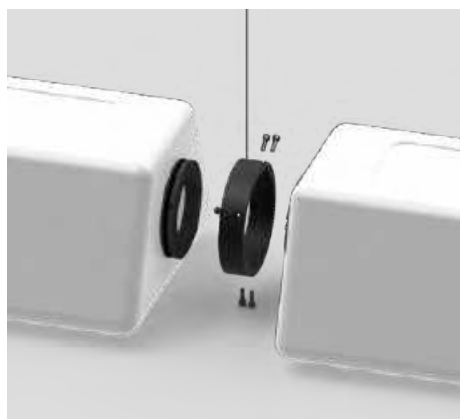

giunto elettrico 5 conduttori
all'interno dei moduli.
electrical joint with 5 conductors inside
the modules.

40834

rosone da fissare al soffitto Ø10 H 3
ceiling rose to be fixed to the ceiling.

40835/BI

cavi di sospensione 500cm
suspension cables

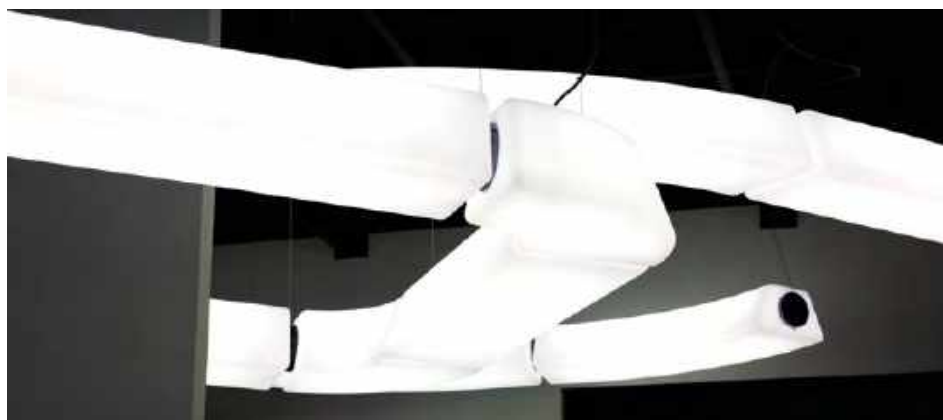

CIRCULAR POL XXL

esempi di composizione / examples of compositions



Esempi di composizione quadrata e circolare formati con l'impiego dei tre moduli base e dei giunti intermedi del sistema. Alimentatori elettronici dimmerabili all'interno dei moduli.

Examples of a square and circular compositions created using the three basic modules and the system intermediate joints. Dimmable electronic drivers inside the modules.



watt	flusso/flux	CCT	Kg	colore/colour	codice/code
------	-------------	-----	----	---------------	-------------

CIRCULAR POL XXL 226x226					
4x60W+4x20W 230V	36000lm	3000K	53	○ bianco/white	2057/XXL/Q/DIM/L/1/BI
4 moduli lineari e 4 moduli angolari 90° / 4 linear modules and 4 90° corner modules					

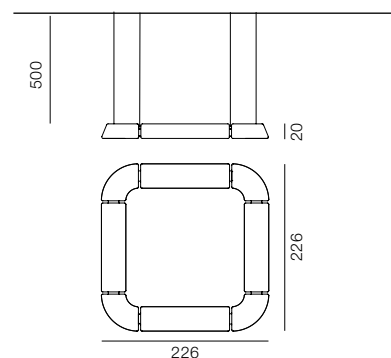

CIRCULAR POL XXL Ø350					
8x60W 230V	54000lm	3000K	69	○ bianco/white	2057/XXL/DIM/L/1/BI
8 moduli curvi 120° / 8 curve modules 120°					

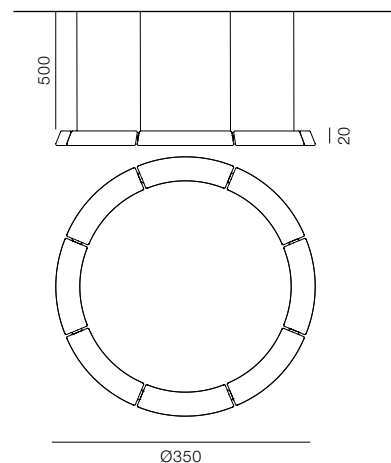

alimentatori elettronici dimmerabili integrati / integrated electronic dimmable drivers







PISTILLO



Un cilindro in metacrilato sospeso con cavi in acciaio emana una luce morbida e diffusa. Posizionato in orizzontale per illuminare un tavolo o verticale per sottolineare un'architettura od un percorso. Da solo o insieme ad altri Pistillo con inclinazioni diverse rende vivo e movimentata lo spazio con dei flash di luce. Sorgente di luce a LED.

A methacrylate cylinder suspended with steel cables that spreads a soft and diffused light. Placed horizontally in order to light up a table or vertically to emphasize an architecture or a pathway. Alone or together with other Pistillo with several inclines, it brings the space to life and livens it up with light flashes. LED light source.

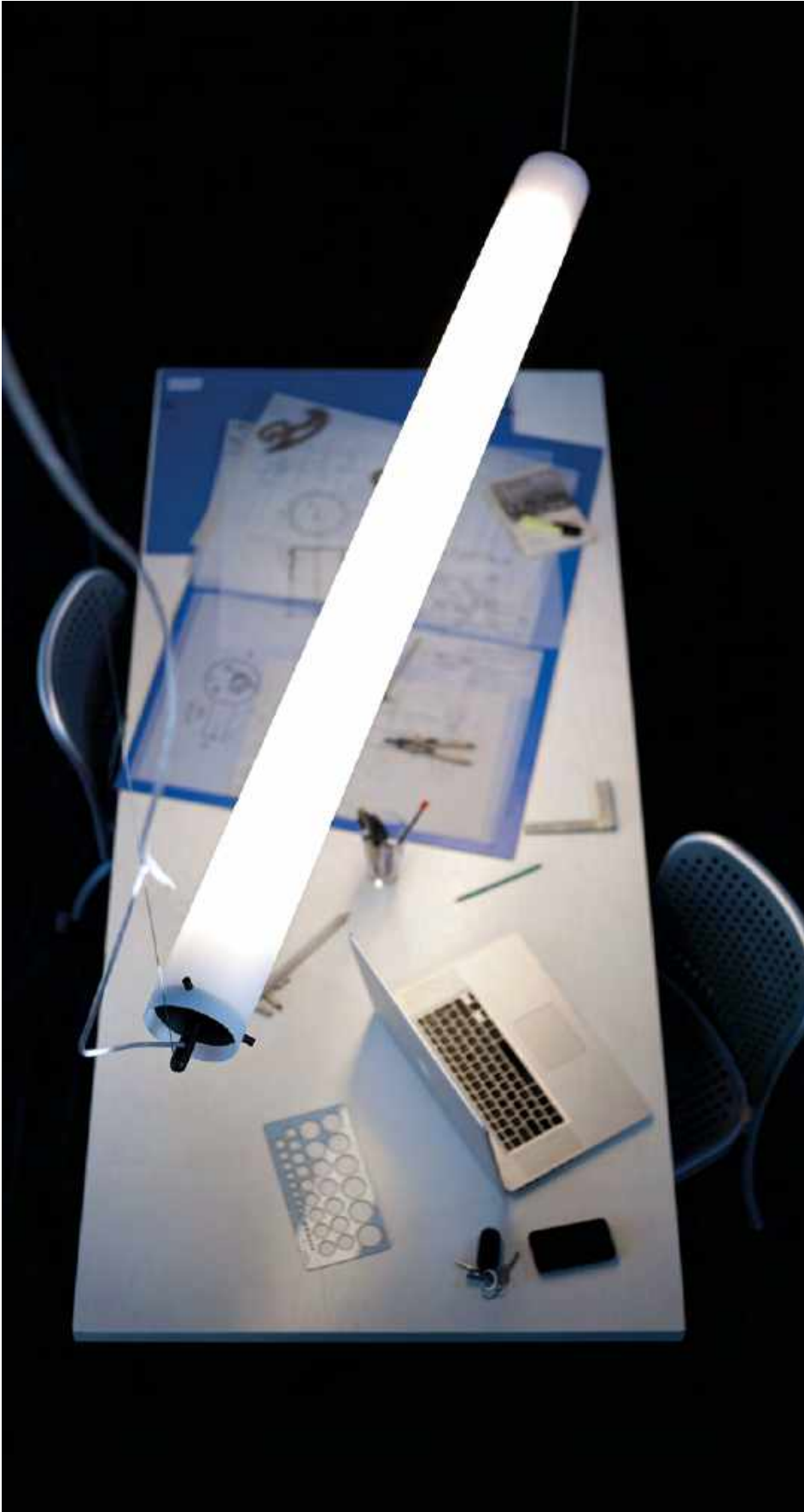

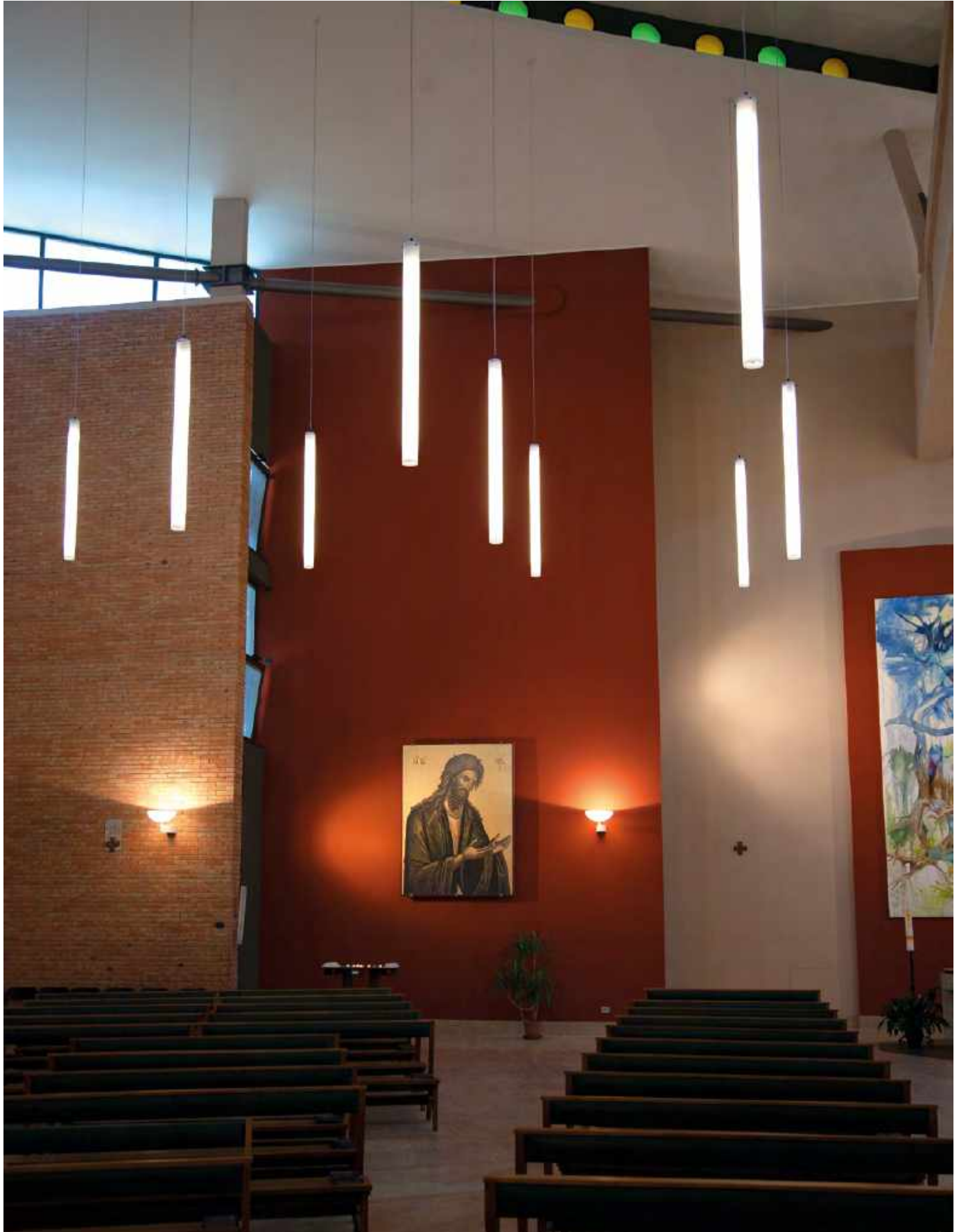

Chiesa Pio X, Modena – arch. Fabrizio Tavoni, ing. Soli



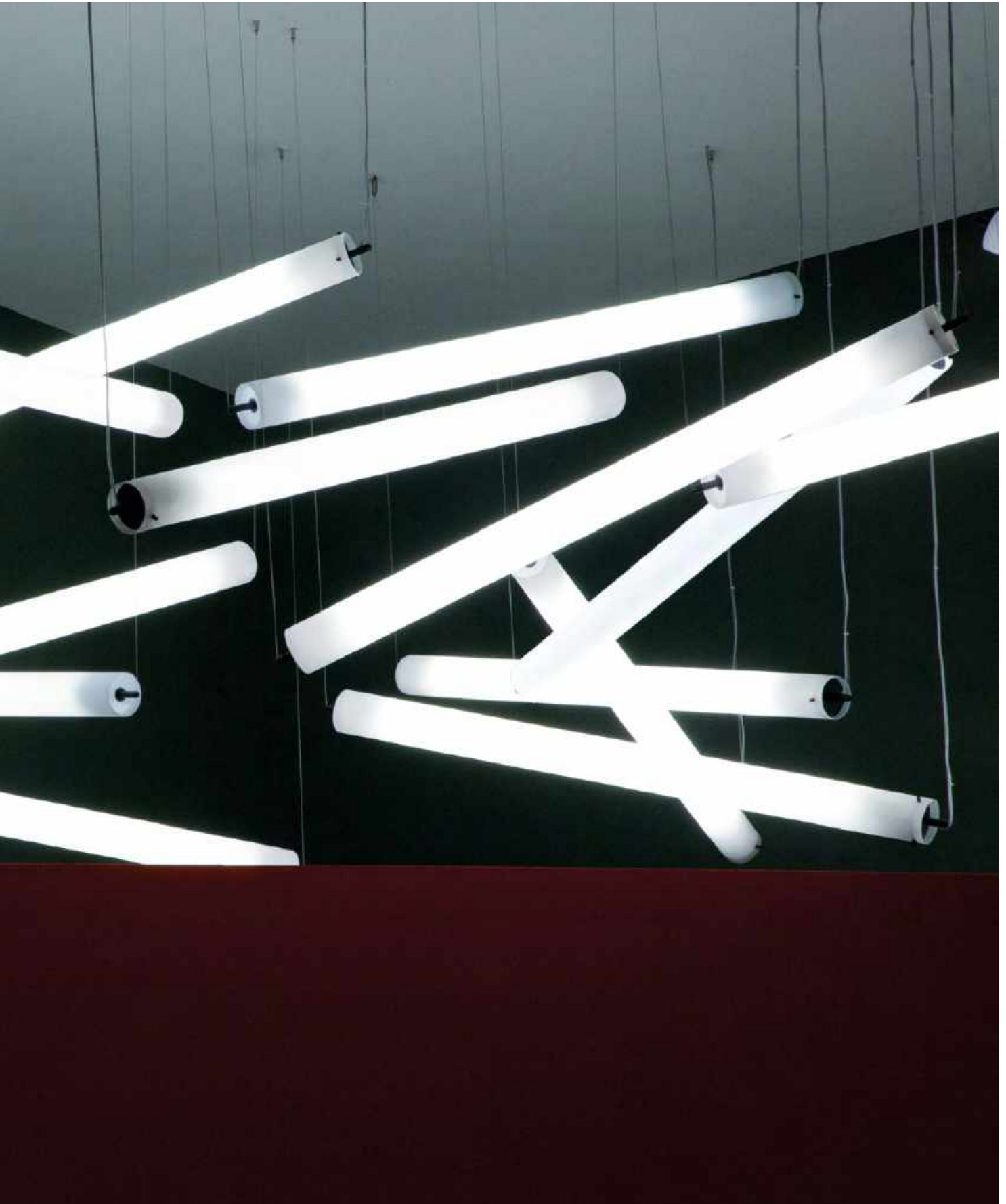

PISTILLO

Lampada a sospensione a luce diffusa, tubo in metacrilato opal bianco, sospeso con 2 cavi o 1 cavo in acciaio (posizione verticale). Completo di alimentatore dimmerabile elettronico integrato nel corpo lampada.

Suspension lamp, diffused light, opal white methacrylate tube, hanged with 2 steel cables or 1 steel cable (vertical position). Dimmable electronic driver included in the body lamp.

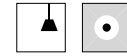

watt	flusso/flux	CCT	Kg	colore/colour	codice/code
PISTILLO LED					
60W 230V	4700lm	3000K	5	○ bianco/white	2063/L/1
non dimmerabile / non dimmable					
60W 230V	4700lm	3000K	5	○ bianco/white	2063/DIM/L/1
dimmerabile / dimmable					
PISTILLO LED RGB					
100W 230V	1000lm		5	○ bianco/white	2063/L
dimmerabile / dimmable					

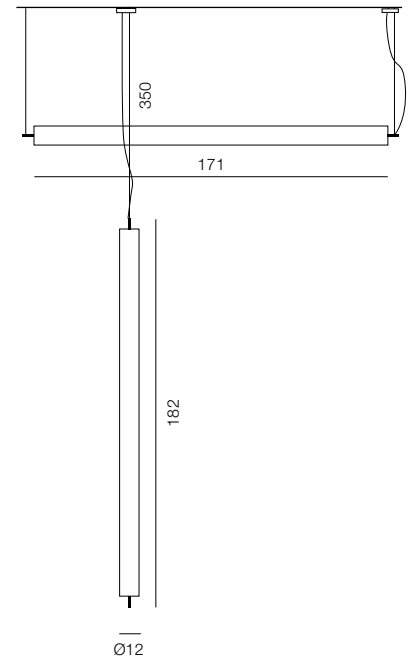

Disponibile a richiesta con dispositivo bluetooth per mod. 2063/L – 2063/DIM/L/1
 Available on request with bluetooth device for mod. 2063/L - 2063/DIM/L/1

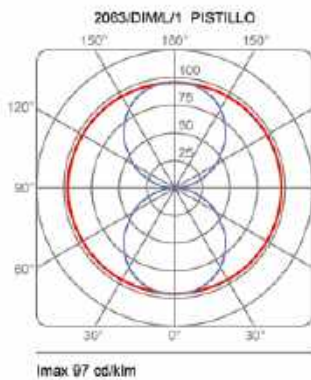



Ristorante il Regio Nero, Firenze



LENT



Una grande lampada sospesa sobria e importante, ma allo stesso tempo sottile ed elegante con i suoi tre colori. Grazie alla sua struttura in materiale fonoassorbente, Lent ti permette di sentire il suono più che il rumore e con la luce centrale di illuminare anche uno spazio.

A large suspended lamp, sober and important but at the same time thin and elegant with its three colours. Thanks to the insulating material it is made with, Lent allows you to hear sounds rather than noise and to illuminate a space with its central light.









LENT

Lampada a sospensione a luce diretta che sviluppa il tema del comfort acustico tramite un riflettore speciale stampato con materiale fonoassorbente e tessuto, in grado di assorbire le onde acustiche rallentandone il riverbero. Spot centrale con sorgente di luce a LED integrata con dissipatore, nella versione con diffusore in policarbonato o con schermo dark-light. Disponibile in tre colori: grigio, giallo senape e verde muschio.

Alimentatore elettronico dimmerabile inserito all'interno del rosone al soffitto.

Hanging lamp, direct light, that develops the theme of acoustic comfort thanks to a special reflector molded with soundproof material and fabric, capable of absorbing sound waves, slowing their reflection. Central spotlight with integrated LED light source and heatsink, in the version with diffuser in polycarbonate or dark-light screen.

Available in three colours: grey, mustard yellow and moss green.

Dimmable electronic driver integrated inside the ceiling rose.

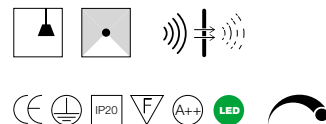

watt flusso/flux CCT Kg colore/colour codice/code

RIFLETTORE FONOASSORBENTE / SOUND-ABSORBING REFLECTOR
con diffusore in policarbonato / with polycarbonate diffuser (A)

27W 230V	3000lm	3000K	11	giallo/yellow	21001/DIM/GI
				grigio/grey	21001/DIM/GR
				verde/green	21001/DIM/VE

RIFLETTORE FONOASSORBENTE / SOUND-ABSORBING REFLECTOR
con schermo dark-light / with dark-light screen (B) UGR<19

27W 230V	3000lm	3000K	11	giallo/yellow	21001/DIM/DK/GI
				grigio/grey	21001/DIM/DK/GR
				verde/green	21001/DIM/DK/VE

rosone / ceiling rose Ø23 H 5,5
alimentatore elettronico dimmerabile / electronic dimmable driver



RIFLETTORE FONOASSORBENTE SOSPESO / SUSPENDED SOUND-ABSORBING REFLECTOR

	giallo/yellow	40133/GI
	grigio/grey	40133/GR
	verde/green	40133/VE

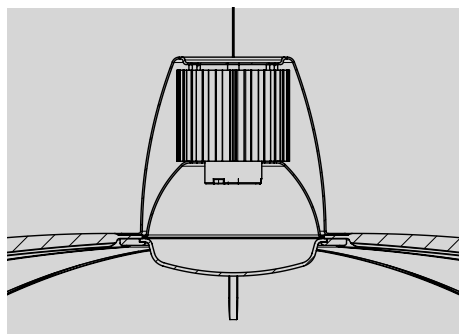
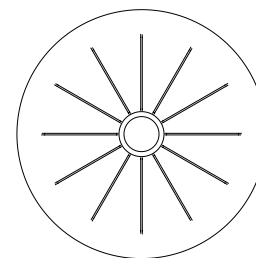
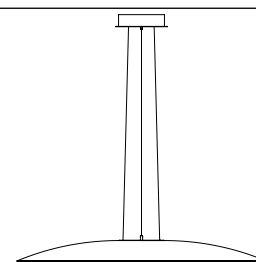
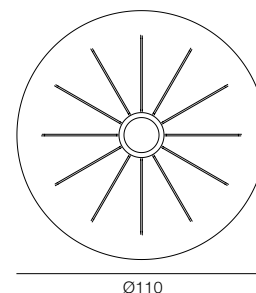
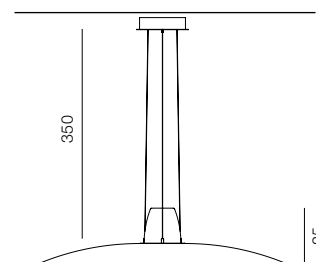

LAMPADA CON DIFFUSORE (A)
LAMP WITH DIFFUSER

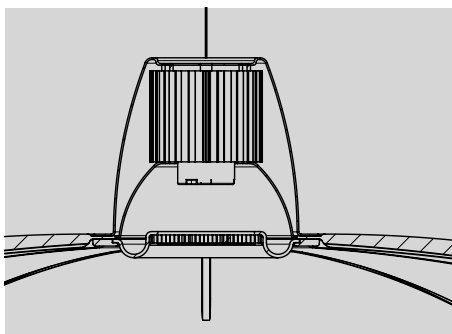

LAMPADA CON SCHERMO DARK-LIGHT (B)
LAMP WITH DARK-LIGHT SCREEN



Calcolo dell'assorbimento acustico in camera riverberante secondo la UNI EN ISO 354.
 Volume della camera riverberante: 161,3 m³

Sound absorption calculation in a reverberation room based on the UNI EN ISO 354 norm.
 Reverberation chamber volume: 161,3 m³

f [Hz]	Aobj [m ²]
<i>Frequenze</i>	
100	0,12
125	0,26
160	0,19
200	0,56
250	0,65
315	0,81
400	0,98
500	1,03
630	0,98
800	1,12
1000	1,19
1250	1,36
1600	1,43
2000	1,56
2500	1,64
3150	1,71
4000	1,79
5000	1,79

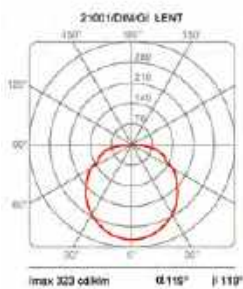
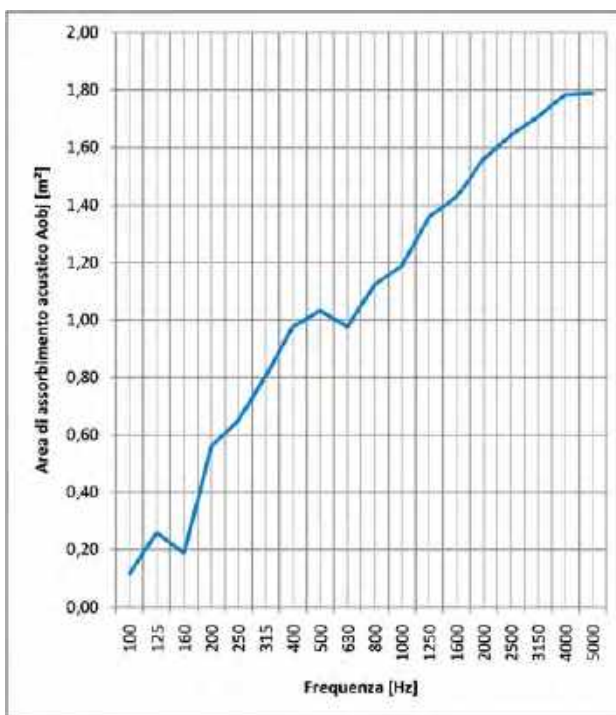



HUSH

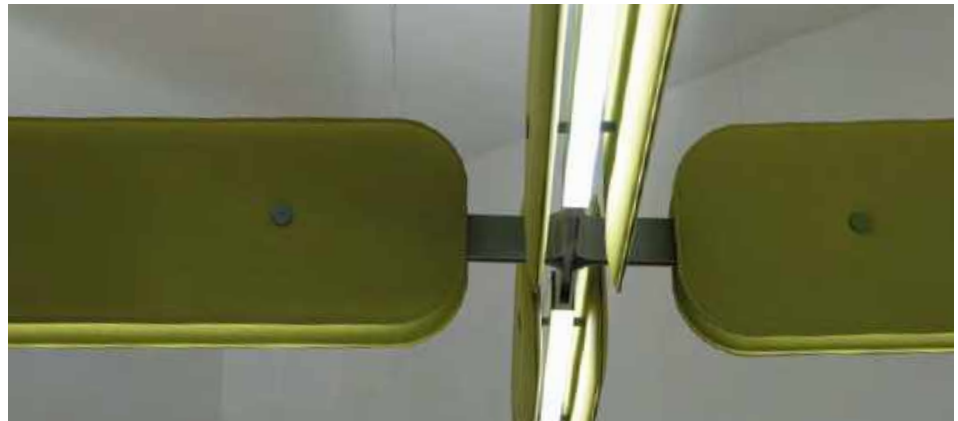

Hush è il nuovo sistema light&sound progettato per la qualità della vita negli ambienti di lavoro e negli spazi condivisi. Hush unisce funzionalità e design in un sistema componibile di moduli a sospensione integrati con pannelli fonoassorbenti realizzati con tecnologia SNOWSOUND© (Caimi Brevetti) in vari colori, che rendono Hush perfetto per arredare ogni ambiente.

I pannelli fonoassorbenti permettono di ottenere un assorbimento selettivo alle diverse frequenze (alte, medie, basse) e quindi di ottimizzare l'acustica dell'ambiente.

Hush is the new light&sound system designed to improve the quality of life in working environments and shared spaces in general. Hush combines functionality and design in a suspended modular system integrated with sound-absorbing panels featuring SNOWSOUND© technology (Caimi Brevetti) and available in various colours, making it a perfect decorating choice for any space.

The sound-absorbing panels allow to obtain a selective absorption at different frequencies (high, middle and low) and thus to optimize the acoustics of the space.



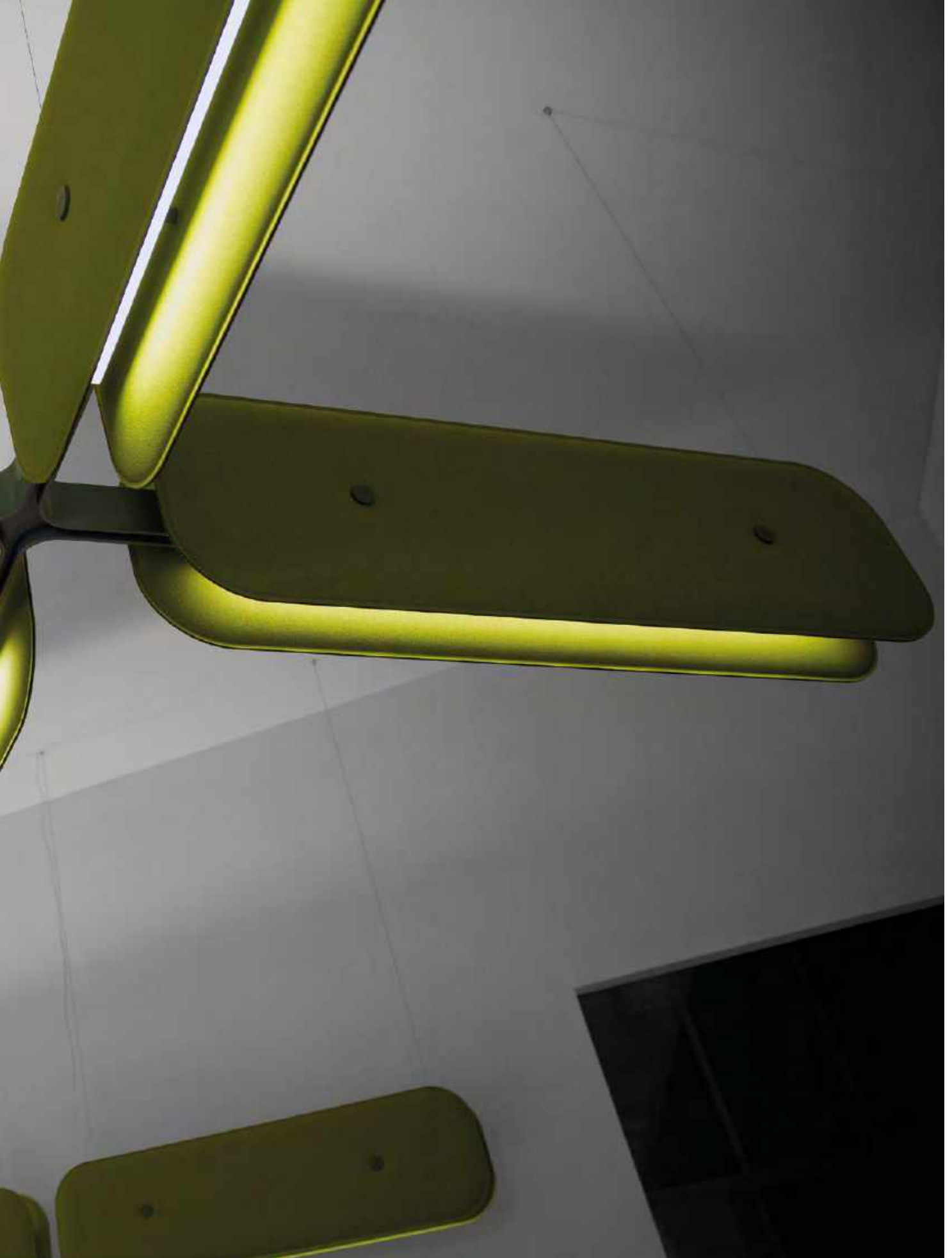









HUSH

pannelli fonoassorbenti / sound-absorbing panels

I suoni sono formati da onde che tendono ad essere riflesse dalle superfici rigide con limitato potere assorbente, quali per esempio il cemento, il marmo o il vetro. In ambienti realizzati con queste tipologie di materiali si possono generare echi e riverberi, spesso molto fastidiosi, che non consentono di ascoltare e dialogare in maniera confortevole. I materiali fonoassorbenti nascono dall'esigenza di migliorare l'acustica in questi ambienti. Le caratteristiche dei prodotti fonoassorbenti tradizionali tendono a manifestare la capacità di assorbire meno le basse frequenze (sotto i 500 Hz), progressivamente di più le medie frequenze (tra i 500 e i 2000 Hz) ed in misura maggiore le alte (sopra i 2000 Hz).

Le tecnologie SNOWSOUND® consentono di ottenere una correzione acustica in modo semplice e rapido, sia in nuovi ambienti che in quelli esistenti. L'esigenza di vivere e lavorare in ambienti meno rumorosi, riducendo il fastidioso riverbero acustico, trova finalmente una risposta in prodotti innovativi adatti a risolvere svariate esigenze.

I pannelli fonoassorbenti realizzati con la pluripremiata tecnologia SNOWSOUND® sono composti da materiale a densità variabile, che permette di ottenere un assorbimento selettivo alle diverse frequenze (alte, medie e basse) e quindi di ottimizzare l'acustica dell'ambiente nonostante lo spessore molto contenuto dei pannelli. I pannelli Snowsound® sono realizzati interamente in poliestere, quindi monomaterici e riciclabili al 100% senza necessità di dover separare il tessuto esterno dal materiale fonoassorbente interno. L'utilizzo di materiali e lavorazioni di alta qualità permettono inoltre di allungare la vita del prodotto con conseguente minor consumo di materiali ed energia. I pannelli non contengono feltri o altri materiali di origine organica difficilmente riciclabili. L'assenza di intercapedini tra tessuto e materiale fonoassorbente e l'assenza di cavità riducono notevolmente la possibilità di accumulare polveri, pollini o di ospitare insetti. Il pannello monomaterico Snowsound nel suo insieme tessuto esterno e materiale fonoassorbente interno, ha Classe 1 Italia di reazione al fuoco ed Euroclass B-s2, d0. I pannelli Snowsound hanno contenuto di formaldeide non rilevabile, test eseguito secondo la norma UNI EN 717-2.

Sounds are formed by waves that tend to be reflected from solid surfaces having limited absorption capacity such as, for example, concrete, marble or glass. In locations made with these types of materials, often very annoying echoes can be created, making it difficult to listen and converse in comfort. Sound absorbing materials are created from the need to improve acoustics in these environments. The sound absorbing characteristics of traditional products tend to demonstrate less capacity to absorb low frequencies (below 500 Hz), progressively more with regard to the midrange (between 500 and 2,000 Hz) and to a greater extent with regard to the high frequencies (above 2,000 Hz).

SNOWSOUND® technologies attain acoustic correction easily and quickly, in new areas as well as in existing spaces. The need to live and work in quiet spaces, reducing the annoying acoustic reverberation, is finally met with these innovative products ideal for resolving a variety of needs.

The sound-absorbing panels created using the multi-award-winning SNOWSOUND® technology are comprised of variable-density material that affords selective absorption of the different frequencies (high, medium, low) and hence allows optimizing the acoustics of the environment despite the panels being very thin. The Snowsound® panels are made in polyester – hence mono-component – and are 100% recyclable without the need to separate the external fabric from the internal sound-absorbing material.

The use of high quality elements also allows extending the life of the product with a consequent lower consumption of materials and energy. The panels do not contain felt or other components of organic origin that are difficult to recycle. The absence of space between the fabric and the sound-absorbing material and the absence of cavities substantially reduce the possibility of the accumulation of dust, pollens or insects. Overall, considering its external fabric and internal sound-absorbing element, the mono-material Snowsound panel is Italian Class 1 as far as reaction to fire, and Euroclass B-s2, d0. Snowsound panels have a negligible formaldehyde content (test carried out pursuant to UNI EN 717-2 standard).



A) 2 Pannelli fonoassorbenti fissati al profilo interno con luce diretta e indiretta.
 A) 2 Sound-absorbing panels fixed to the inner structure with direct and indirect light.

B) Pannello fonoassorbente singolo con attacchi di sospensione.
 B) Single sound-absorbing panel with attachments for hanging cables.

SOUND QUALITY

Il grafico mostra come i pannelli Snowsound incidono sull'acustica di un ambiente:
 The graphic shows how the Snowsound panels affect the acoustics of a room:



L'assenza di cornici rende le superfici dei pannelli Snowsound completamente fonoassorbenti.

The absence of frames makes the surfaces of the Snowsound panels completely soundproof.

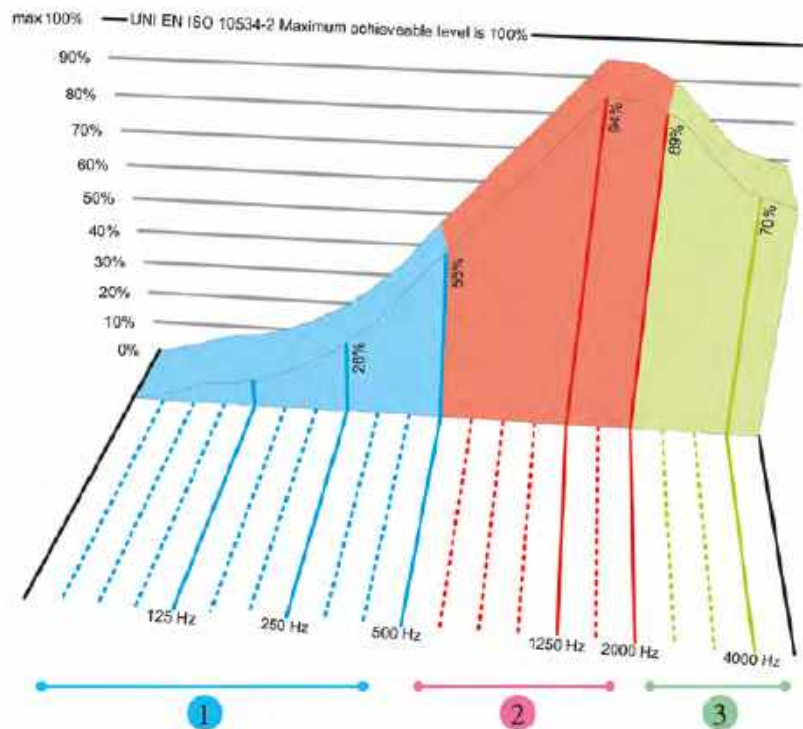

HUSH

sospensione luce diretta-indiretta / suspension direct-indirect light



Un sistema formato da moduli componibili fonoassorbenti.

Hush è composto da: un profilo interno in alluminio con sorgente di luce LED diretta e indiretta a cui vengono fissati lateralmente i 2 pannelli fonoassorbenti rivestiti in tessuto di vari colori.

Alimentatore dimmerabile remoto o da inserire all'interno del rosone al soffitto.

Disponibile come modulo singolo a sospensione o unito ad altri moduli tramite giunti e con particolari attacchi nella versione a parete.

UGR<19

A system made up of sound-absorbing modular components.

Hush is composed of: an inner aluminium element for direct and indirect light with LED light source, to which two sound-absorbing side panels covered in different colour fabric are fixed.

Remote dimmable driver or to be placed inside the ceiling rose.

Available as a single hanging module or joined together with other modules through joints and with particular brackets in the wall version.

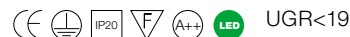

watt	flusso/flux	CCT	Kg	colore/colour	codice/code
------	-------------	-----	----	---------------	-------------

PROFILO INTERNO / INNER PROFILE (A)

profilo interno (A) a luce diretta e indiretta predisposto per fissare i pannelli fonoassorbenti (B)
inner profile (A) with direct and indirect light arranged to fix sound-absorbing panels (B)

luce diretta / direct light

47W 24V	4620lm	3000K	2,5	● grigio/grey	40074/GR
---------	--------	-------	-----	---------------	----------

+

luce indiretta / indirect light

28W 24V	1944lm	3000K			
---------	--------	-------	--	--	--

testata terminale / terminal head (C)

● grigio/grey	40076
---------------	-------

testata intermedia / intermediate head (E)

● grigio/grey	40075
---------------	-------

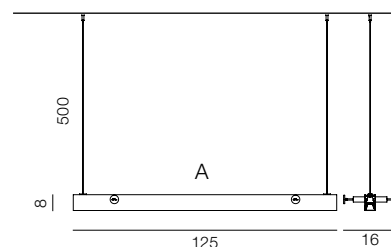

GIUNTI / JOINTS (D)

giunto lineare / linear joint

1	● grigio/grey	40078
---	---------------	-------

giunto 90° / joint 90°

1	● grigio/grey	40077
---	---------------	-------

giunto a T / T-joint

1,5	● grigio/grey	40079
-----	---------------	-------

giunto a croce / cross joint

2	● grigio/grey	40080
---	---------------	-------

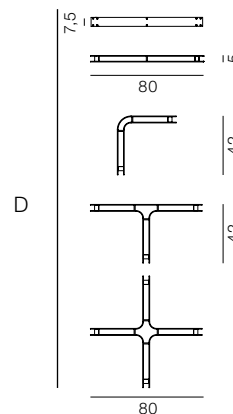

PANNELLO FONOASSORBENTE / SOUND-ABSORBING PANEL (B)

pannello da fissare al profilo interno / panel to be fixed to the inner profile (B)

2,3	○ bianco/white	40112/BI
-----	----------------	----------

	● verde/green	40112/VE
--	---------------	----------



SNOWSOUND© (Caimi Brevetti)

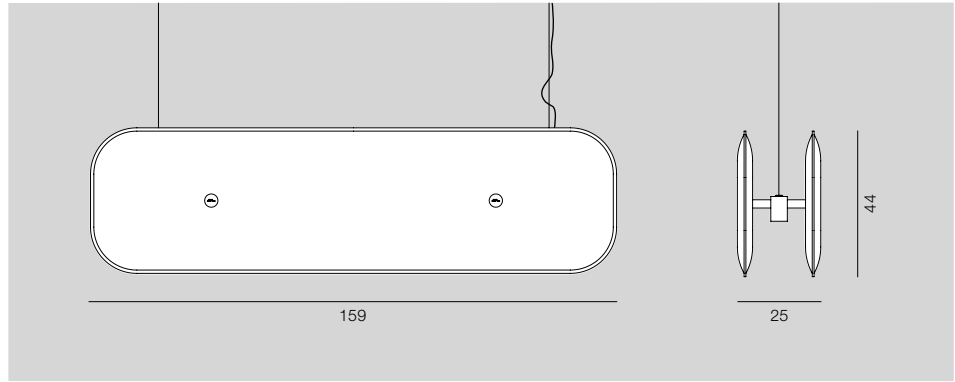

ESEMPI DI COMPOSIZIONE / EXAMPLES OF COMPOSITION

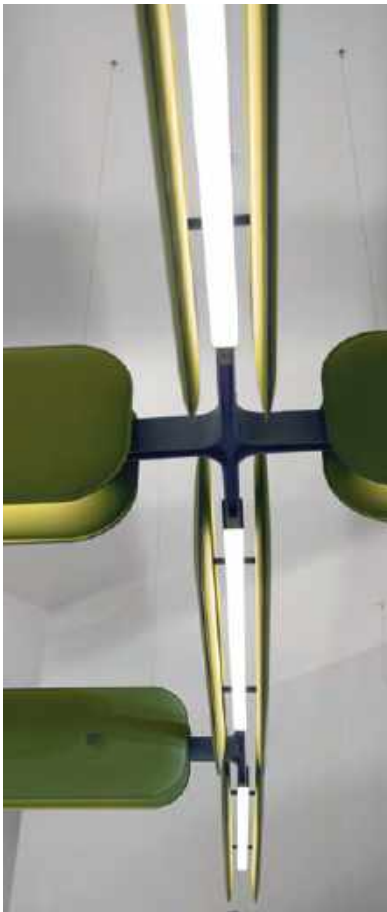

MODULO SINGOLO / SINGLE MODULE:

- (A) 1 profilo interno
1 inner profile
- (B) 2 pannelli fonoassorbenti
2 sound-absorbing panels
- (C) 2 testate terminali
2 terminal heads

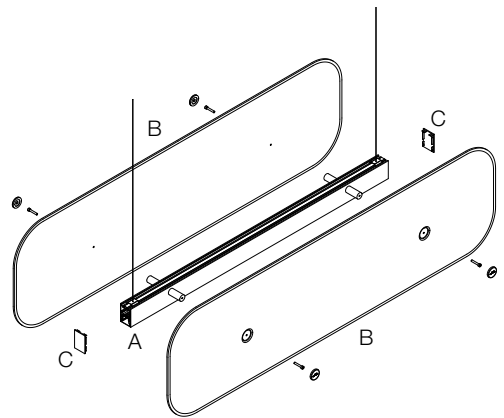

DUE MODULI / TWO MODULES:

- (A) 2 profil interni
2 inner profiles
- (C) 2 testate terminali
2 terminal heads
- (E) 2 testate intermedie
2 intermediate heads
- (D) 1 giunto lineare
1 linear joint
- (B) 4 pannelli fonoassorbenti
4 sound-absorbing panels

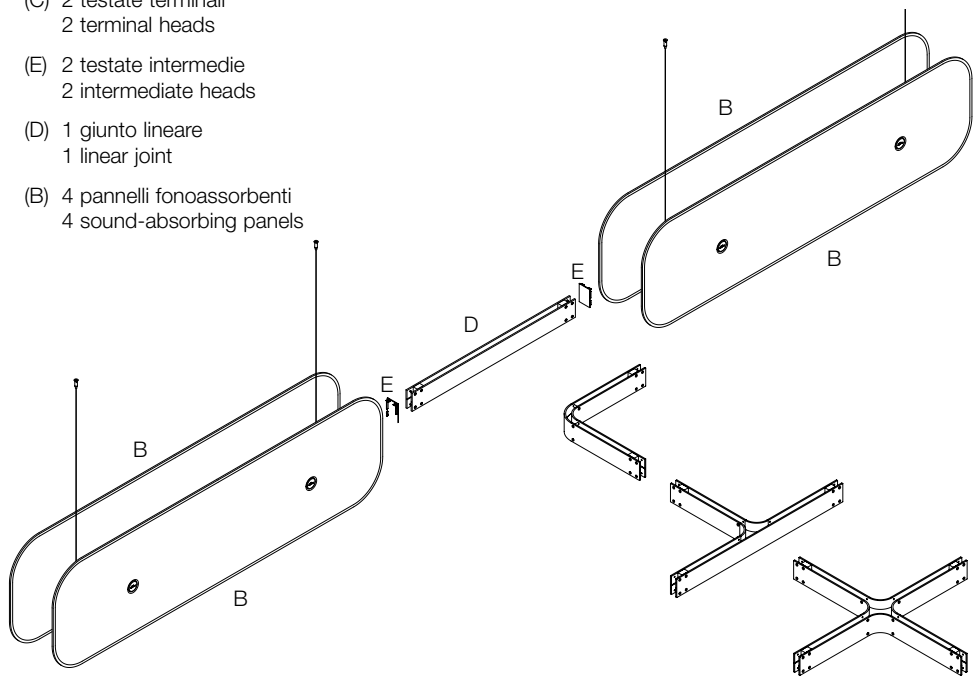

HUSH

rosone /ceiling rose

Rosone completo di alimentatore elettronico dimmerabile e non dimmerabile per la versione a sospensione per singolo modulo o per massimo quattro moduli uniti con i diversi giunti.

Complete ceiling rose with dimmable and non-dimmable electronic driver for the suspension for the single module or for up to four modules connected together through joints.



watt	Kg	codice/code
rosone con alimentatore per 1 modulo singolo non dimmerabile - 35x8 H 5 cm ceiling rose with driver for 1 single non-dimmable module		
75W 230/24V	1,5	40119
rosone con alimentatore per 1 modulo dimmerabile - 35x8 H 5 cm ceiling rose with driver for 1 single dimmable module		
75W 230/24V	1,5	40120
<input type="checkbox"/> 0-10V <input type="checkbox"/> 1-10V <input type="checkbox"/> Triac 5		

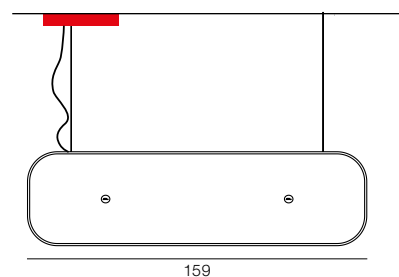

rosone con alimentatore per max 4 moduli non dimmerabili - 60x8 H 5 cm ceiling rose with driver for up to 4 non-dimmable modules		
300W 230/24V	2	40121
rosone con alimentatore per max 4 moduli dimmerabili - 60x8 H 5 cm ceiling rose with driver for up to 4 dimmable modules		
300W 230/24V	2	40122
<input type="checkbox"/> 0-10V <input type="checkbox"/> 1-10V <input type="checkbox"/> Triac 5		

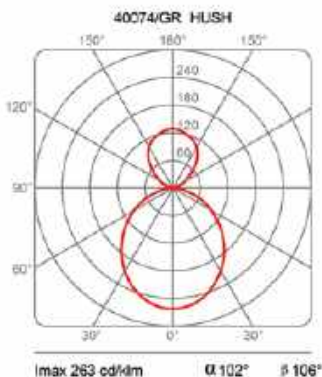
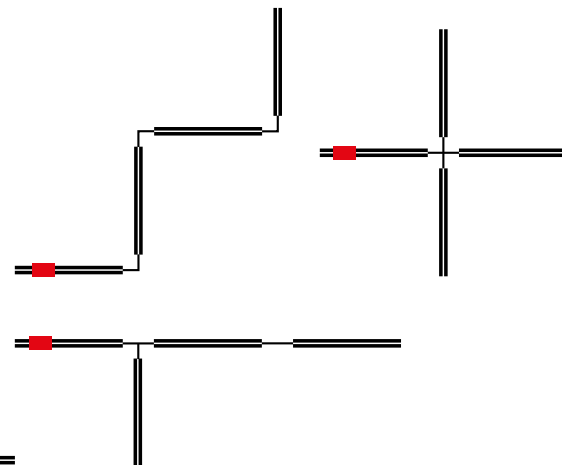

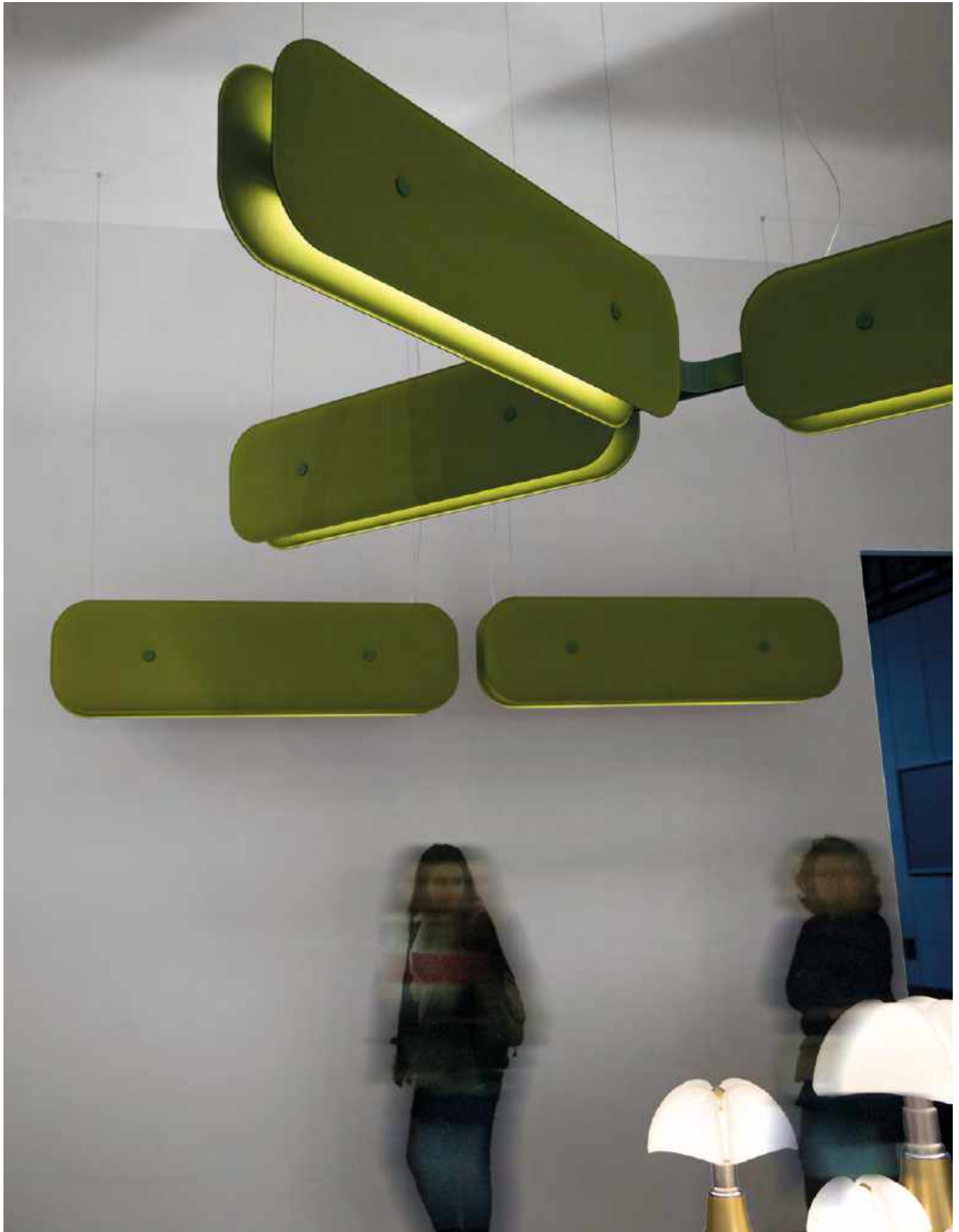

HUSH

parete luce diretta-indiretta / wall direct-indirect light

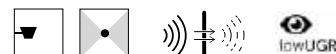

I moduli oltre che a sospensione possono essere fissati con particolari supporti a parete. Il sistema a parete è formato da: un profilo interno in alluminio a luce diretta e indiretta con sorgente di luce LED a cui viene fissato lateralmente 1 pannello fonoassorbente e supporti per attacco a parete. Alimentatore integrato.

UGR compatibile

In addition to the suspension version, the modules can be fixed to the wall using special supports. The wall system is made of: an inner aluminium structure with direct and indirect light with LED light source to which 1 sound-absorbing panel is fixed laterally, and supports for wall mounting. Integrated driver.

compatible UGR

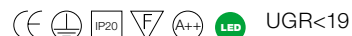

watt	flusso/flux	CCT	Kg	colore/colour	codice/code
------	-------------	-----	----	---------------	-------------

PROFILO INTERNO / INNER PROFILE (A)

profilo interno a luce diretta e indiretta con supporto per fissare il pannello fonoassorbente
inner profile with direct and indirect light arranged to fix sound-absorbing panels

luce diretta / direct light

47W 230V 4620lm 3000K

+

luce indiretta / indirect light

28W 230V 1944lm 3000K 2,5 ● grigio/grey 40074.2/GR

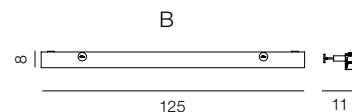

alimentatore elettronico integrato / integrated driver

ATTACCO A PARETE / WALL MOUNTING

testata per supporto parete / head for wall support (E)

0,2 ● grigio/grey 40075



kit 2 supporti a parete / 2 wall supports kit (F)

0,2 ● grigio/grey 40132/GR



PANNELLO FONOASSORBENTE / SOUND ABSORBING PANEL (B)

pannello da fissare al profilo interno / panel to be fixed to the inner profile

2,3 ○ bianco/white 40112/BI

● verde/green 40112/VE



SNOWSOUND© (Caimi Brevetti)

Lampada da parete composta da:
1 profilo interno (A), 1 pannello fonoassorbente (B),
2 attacchi a parete (F) e due testate (E).

Wall lamp composed of:
1 inner-profile (A), 1 sound-absorbing panel (B),
2 wall connections (F) and 2 head (E).

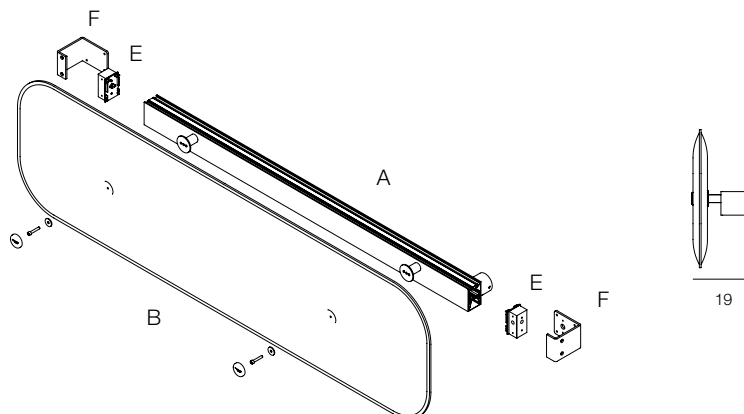

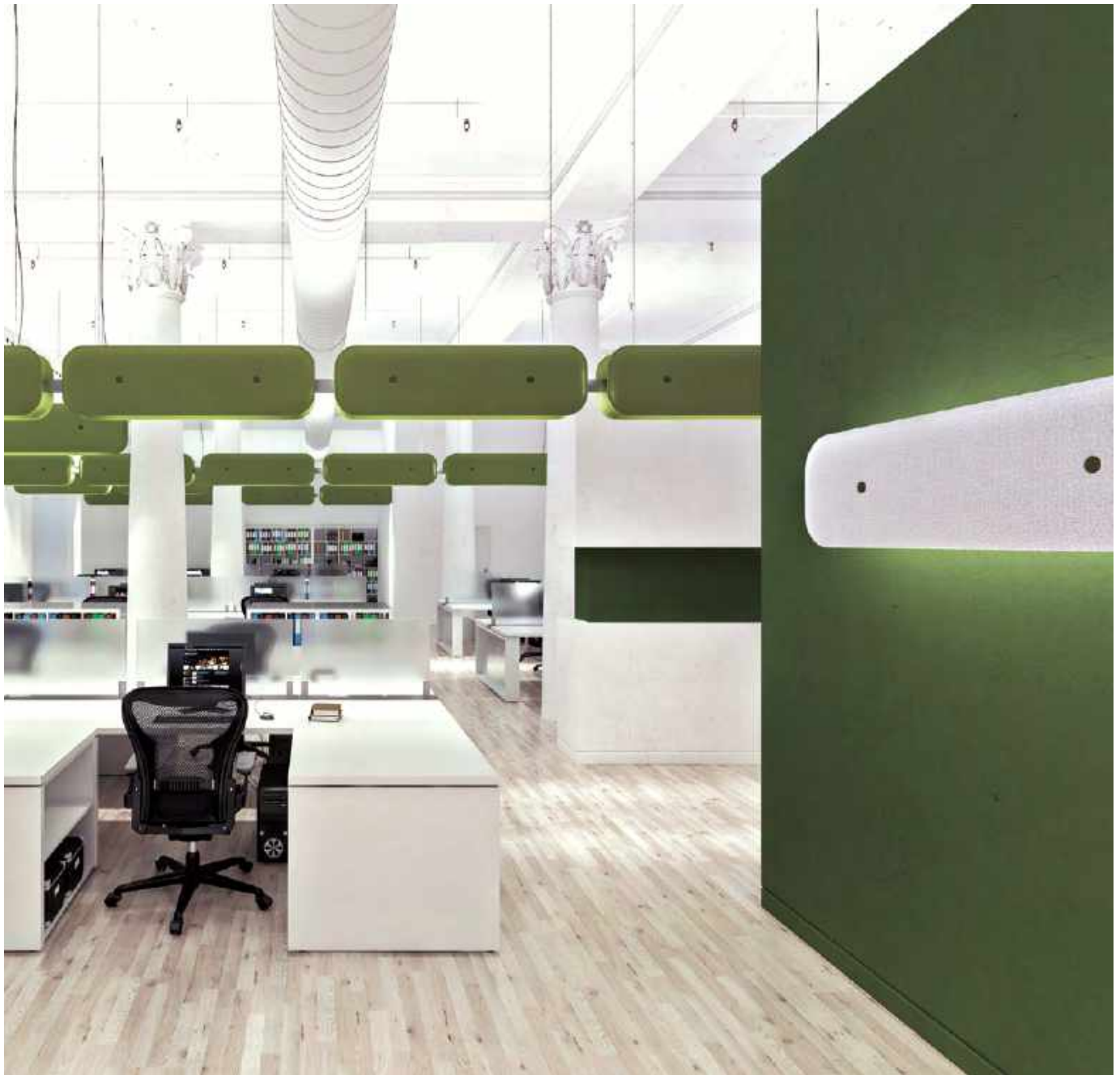

HUSH

pannelli singoli fonoassorbenti / individual sound-absorbing panels



I pannelli fonoassorbenti possono essere sospesi con cavi in acciaio o fissati a parete come moduli singoli tramite supporti.

The sound-absorbing panels can be either suspended with steel cables or fixed to the wall as individual modules with supports.

	Kg	colore/colour	codice/code
PANNELLO A SOSPENSIONE / SUSPENSION PANEL			
pannello singolo con attacchi di sospensione / single panel with suspension supports			
2,5	○ bianco/white	40112.1/BI	
	● verde/green	40112.1/VE	

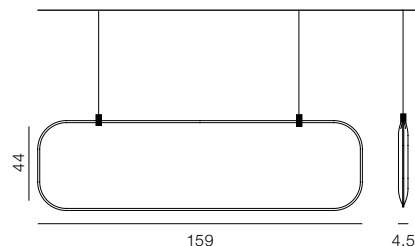

PANNELLO DA PARETE / WALL PANEL			
pannello singolo con attacchi per parete / single panel with wall supports			
2,5	○ bianco/white	40112/BI	
	● verde/green	40112/VE	
kit attacco a parete / wall support kit Ø5 H 5	● grigio/grey	40134/GR	

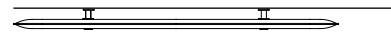
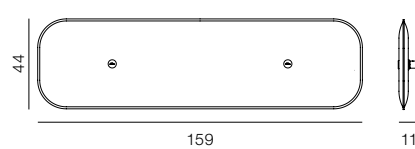

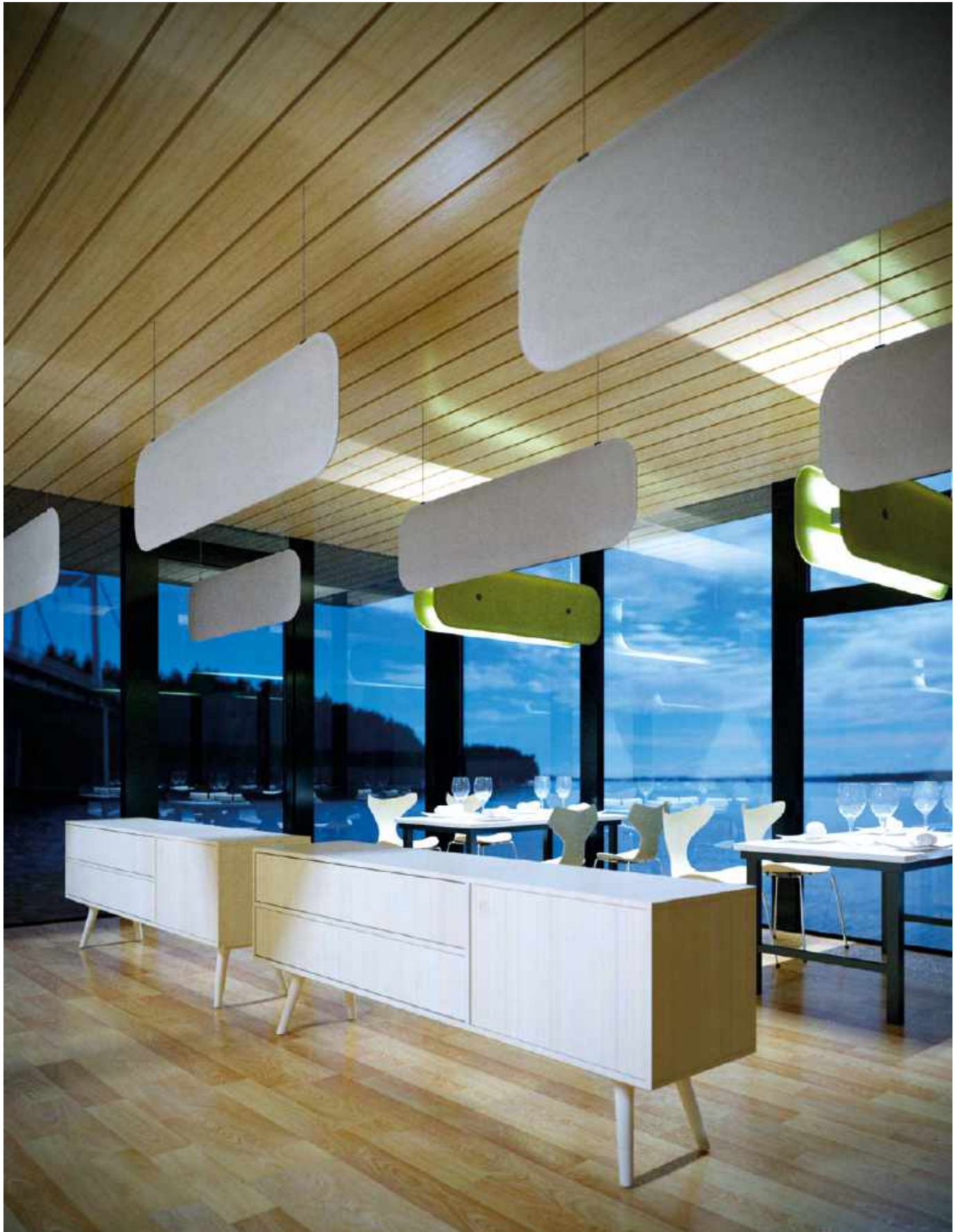

HUSH

profilo sospeso a luce diretta-indiretta / direct-indirect light suspension profile



Solo profilo interno a luce diretta e indiretta a sospensione (senza pannelli fonoassorbenti) da usare dove è necessaria più luce nell'ambiente. Struttura in alluminio estruso verniciato nel colore grigio. Sorgente di luce a LED. Alimentatore dimmerabile remoto o da inserire all'interno del rosone al soffitto. Per il rosone da utilizzare vedi pagina dedicata

Hanging inner profile with direct and indirect light (without sound-absorbing panels) convenient where more light is needed in the room. Extruded aluminium structure painted in grey colour. LED light source. Remote dimmable driver or to be placed inside the ceiling rose. For the ceiling rose to be used, see the dedicated page

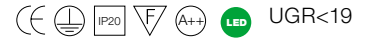

Per collegare in linea profilo con profilo o profilo con modulo di collegamento, occorre utilizzare il giunto meccanico 40159.

To connect profile to profile or profile to connection module, both in line, the mechanical joint 40159 must always be used.

watt	flusso/flux	CCT	Kg	colore/colour	codice/code
------	-------------	-----	----	---------------	-------------

PROFILO INTERNO CON LUCE / INNER PROFILE WITH LIGHT

solo profilo da sospendere, senza pannelli fonoassorbenti
hanging profile without sound-absorbing panels

luce diretta / direct light 47W 24V	4620lm	3000K	2,5	● grigio/grey	40074.1/GR
+ luce indiretta / indirect light 28W 24V	1944lm	3000K			

UGR compatibile / UGR compatible

testata terminale / terminal head	● grigio/grey	40076
giunto meccanico / mechanical joint		40159

GIUNTI CON LUCE DIRETTA-INDIRETTA / JOINTS WITH DIRECT-INDIRECT LIGHT

giunto lineare / linear joint

12+7,2W	1170+500lm	3000K	● grigio/grey	40078.1
---------	------------	-------	---------------	---------

giunto 90° / 90° joint

13+8W	1270+560lm	3000K	● grigio/grey	40077.1
-------	------------	-------	---------------	---------

giunto a T / T-joint

17,5+10,8W	1710+750lm	3000K	● grigio/grey	40079.1
------------	------------	-------	---------------	---------

giunto a croce / cross joint

23,5+14,5W	2300+1010lm	3000K	● grigio/grey	40080.1
------------	-------------	-------	---------------	---------

rosone vedi pagina dedicata / ceiling roses see dedicated page 170

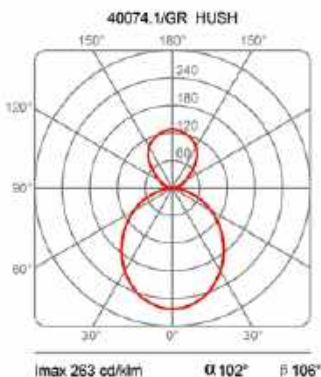
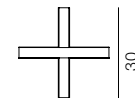
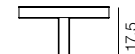
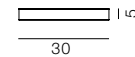
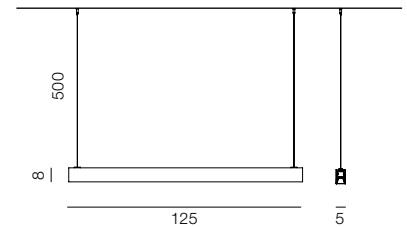



HUSH

profilo interno a parete a luce diretta-indiretta / direct-indirect wall inner profile



Solo profilo interno a luce diretta e indiretta con attacchi per parete (senza pannelli fonoassorbenti) da usare dove è necessaria più luce nell'ambiente. Struttura in alluminio estruso verniciato nel colore grigio. Sorgente di luce a LED. Alimentatore integrato.

Wall inner profile with direct and indirect light (without sound-absorbing panels) convenient where more light is needed in the room. Extruded aluminium structure painted in grey colour. LED light source. Integrated driver.

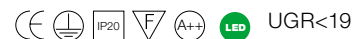

watt	flusso/flux	CCT	Kg	colore/colour	codice/code
------	-------------	-----	----	---------------	-------------

PROFILO INTERNO CON LUCE / INNER PROFILE WITH LIGHT (H)

solo profilo da parete, senza pannelli fonoassorbenti
wall profile without sound-absorbing panels

luce diretta / direct light 47W 230V	4620lm	3000K	2,5	● grigio/grey	40074.3/GR
+ luce indiretta / indirect light 28W 230V	1944lm	3000K			

alimentatore elettronico integrato / integrated driver

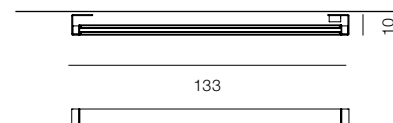

ATTACCO A PARETE / WALL MOUNTING

testata per supporto parete / head for wall support (E)	0,2	● grigio/grey	40075
kit 2 supporti a parete / 2 wall supports kit (F)	0,2	● grigio/grey	40132/GR

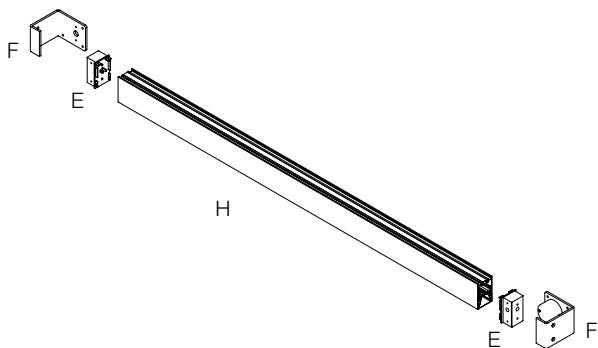



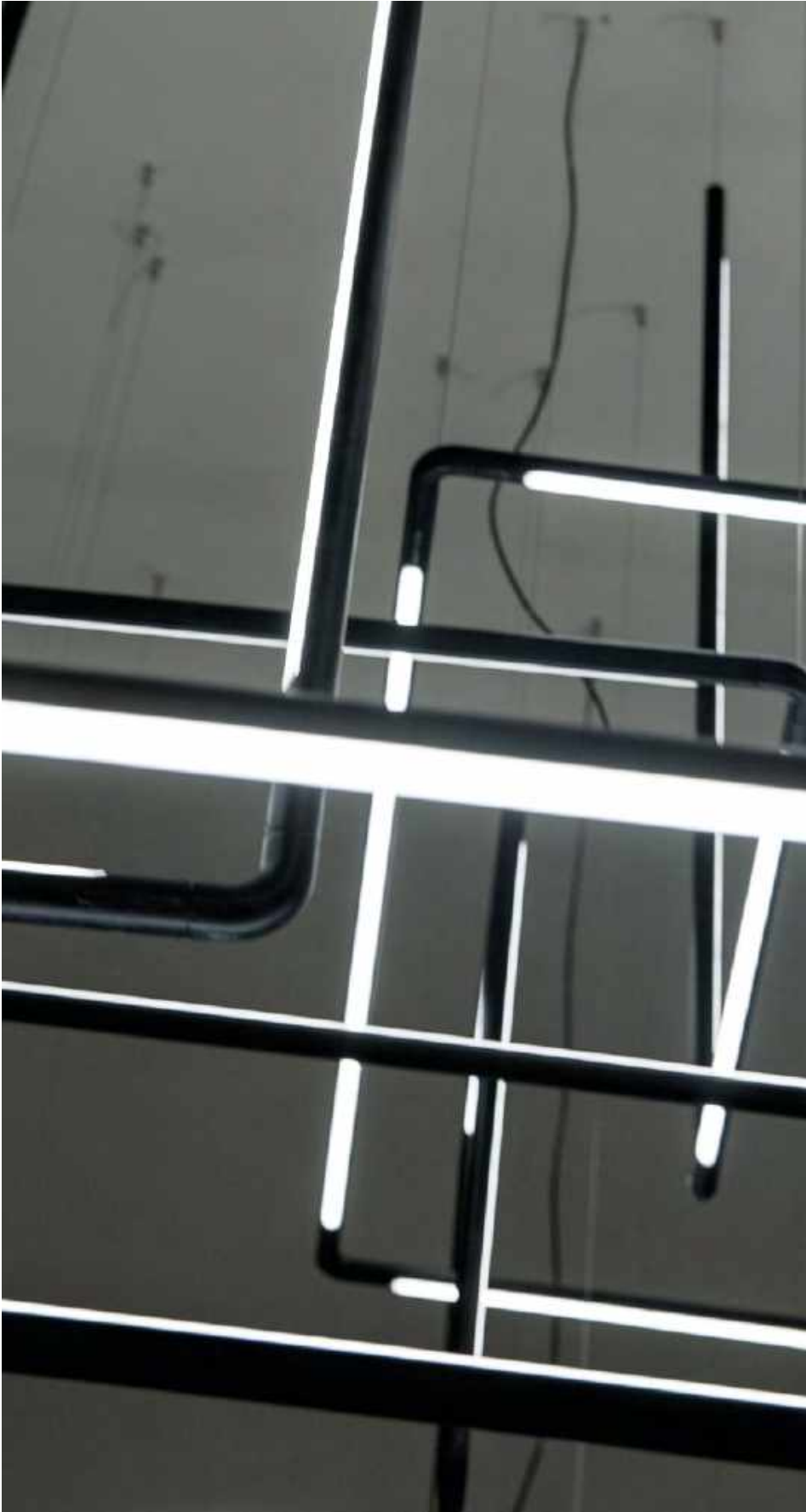

COLIBRÌ

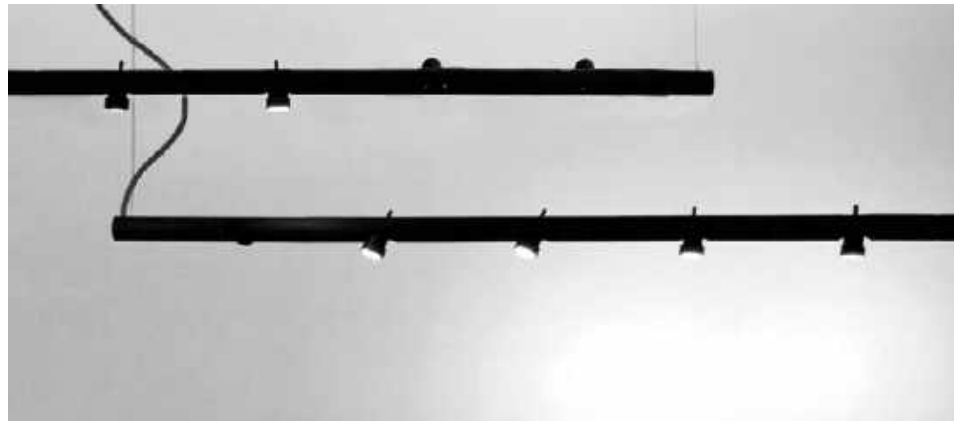

Una famiglia che comprende lampade a sospensione, parete e da terra orientabili, a luce diffusa o con spot direzionabili per una luce d'accento.

I diversi giunti di connessione, a magnete, lineare e ad angolo retto, permettono una versatilità a Colibrì, così da poter rispondere alle varie esigenze di illuminazione di ambienti, sia residenziali che professionali.

Le versioni da terra e da tavolo sono presenti nel catalogo lampade.

A family that includes suspension lamps, wall and floor adjustable lamps, with diffused light or with adjustable spotlights for accent lighting.

The different connection joints, with magnet, linear and at right angles, afford Colibrì versatility, allowing it to respond to the lighting demands for different environments, both residential and professional.

Floor and table versions can be found in the lamp catalogue.

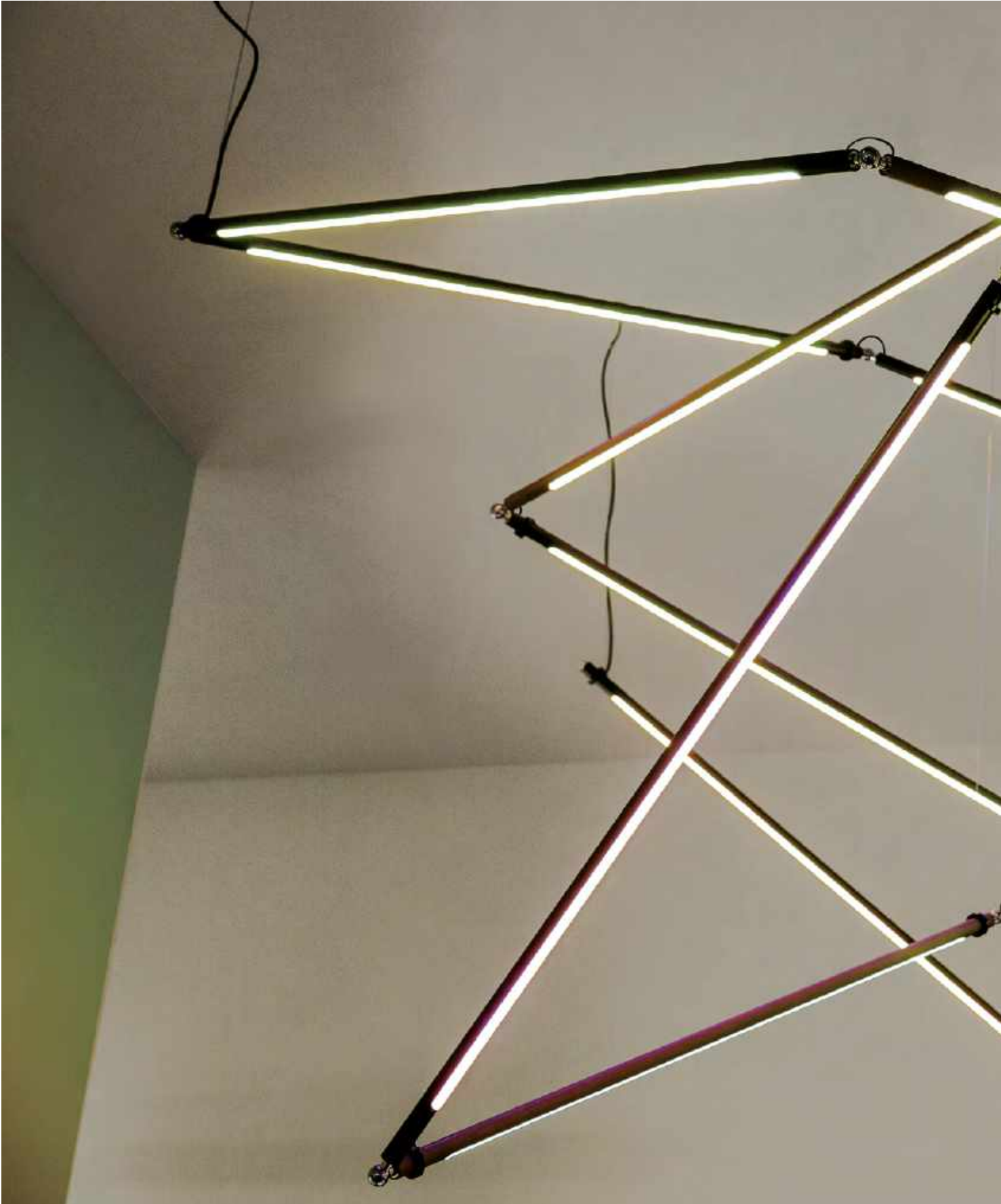

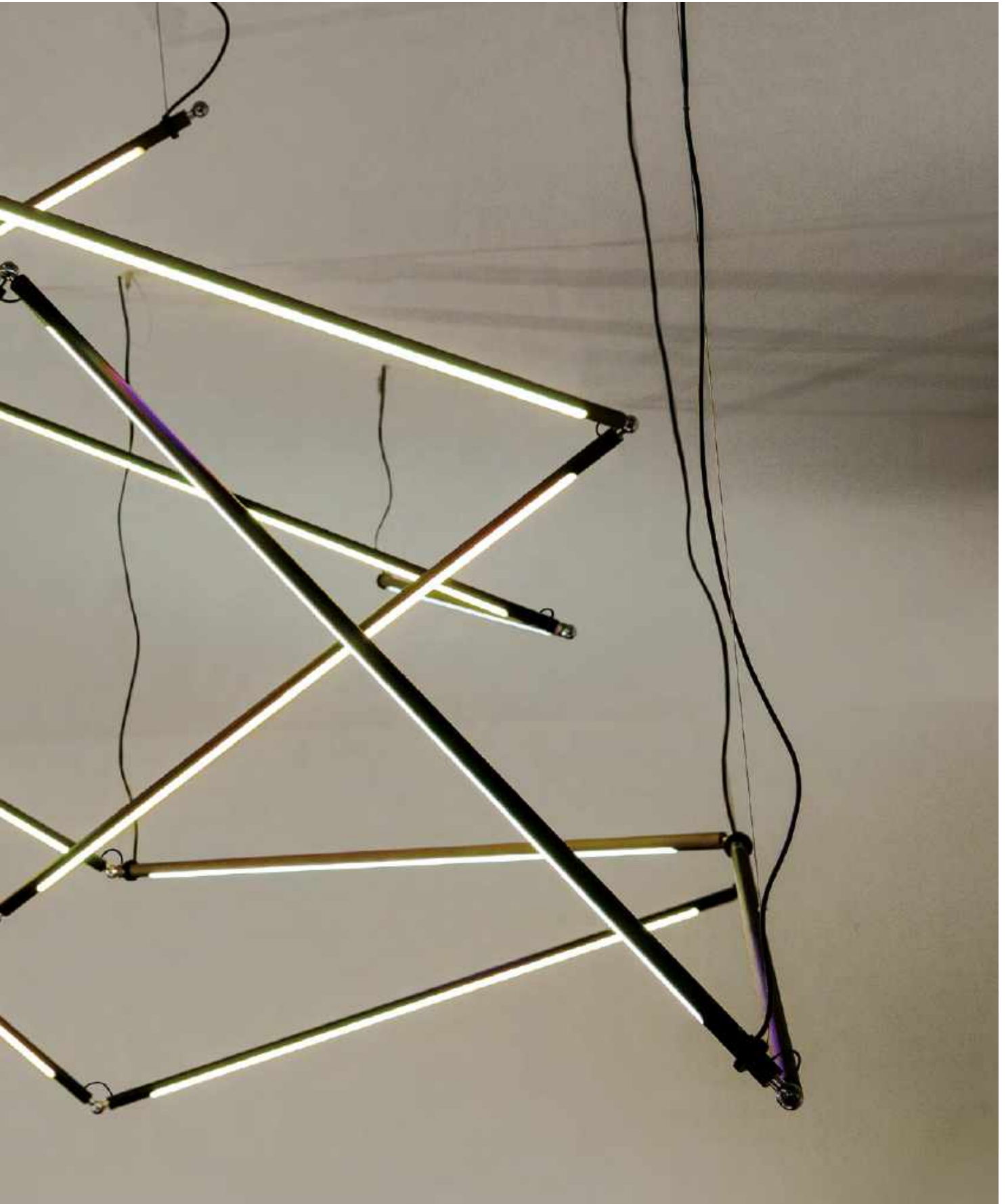









Showroom Nike – Dubai











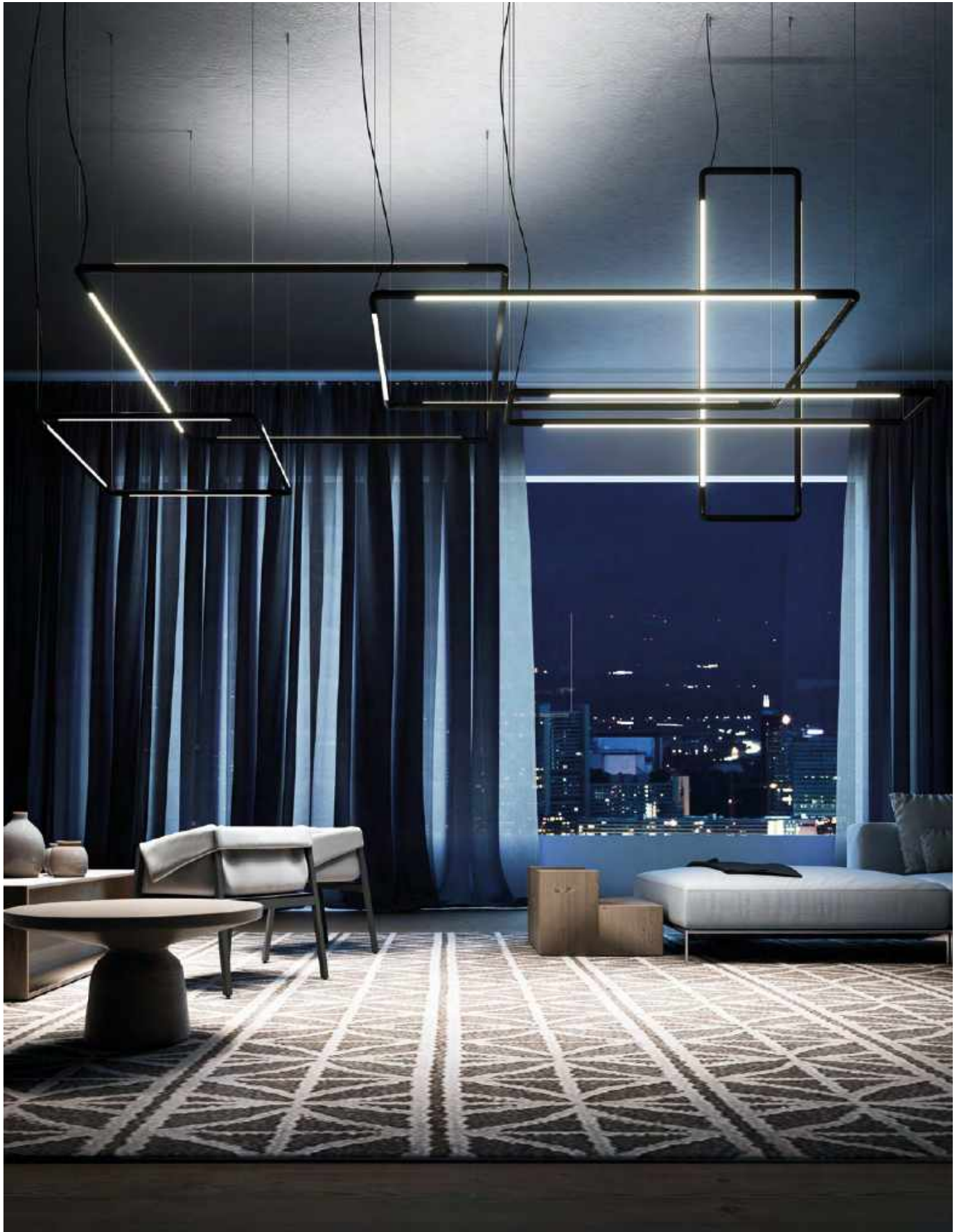





Hotel Kenso Psarou, Mykonos, Grecia – arch. Alexandros Kolovos













COLIBRÌ

magnetico a sospensione e parete / magnetic suspension-wall



Sistema a moduli tubolari componibili e orientabili per sorgente di luce a LED 24V. Un giunto sferico a magnete permette al Colibrì di assumere diverse angolazioni, in modo da creare varie configurazioni nello spazio e sulla parete. I colibrì sono sospesi o fissati a parete/soffitto come modulo singolo o uniti tra loro con il cavo di alimentazione a 1/2/3 moduli continui, da collegare poi all'alimentatore remoto o inserito all'interno del rosone.

Modular system with adjustable tubular modules, for 24V LED light source. A spherical magnetic joint allows Colibrì to be tilted at different angles, creating various configurations in the space it is placed in and on the wall. Colibrì can be suspended or fixed to the wall/ceiling as single module or joined through a power cable having 1/2/3 continuous modules. These can then be connected to the remote driver or placed inside the ceiling rose.



watt	flusso/flux	CCT	Kg	colore/colour	codice/code
1 MODULO / MODULE					
1x14W 24V	1x2300lm	3000K	1,5	● nero/black ● bronzo/bronze	2080/1/NE 2080/1/BZ
2 MODULI / MODULES					
2x14W 24V	2x2300lm	3000K	3,1	● nero/black ● bronzo/bronze	2080/2/NE 2080/2/BZ
3 MODULI / MODULES					
3x14W 24V	3x2300lm	3000K	4,6	● nero/black ● bronzo/bronze	2080/3/NE 2080/3/BZ

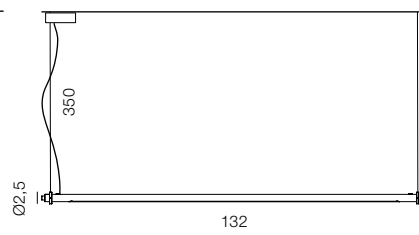

magnete sferico / spherical magnet Ø2,6	0,07				30836
pellicola radiant / radiant film	0,1			● multicolor	40072

attacco a parete / wall support Ø2,5 L4				● nero/black ● bronzo/bronze	40123/NE 40123/BZ
attacco a parete / wall support Ø2,5 L8				● nero/black ● bronzo/bronze	40123.1/NE 40123.1/BZ



ROSONE con alimentatore max 3 moduli / CEILING ROSE with driver up to 3 modules

75W 230/24V	1			● nero/black ● bronzo/bronze	40114/NE 40114/BZ
su richiesta con alimentatore dimmerabile dimmbale driver available on request.					

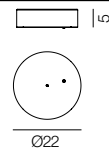

kit alimentatore a spina / driver and plug kit					40167/NE
--	--	--	--	--	----------

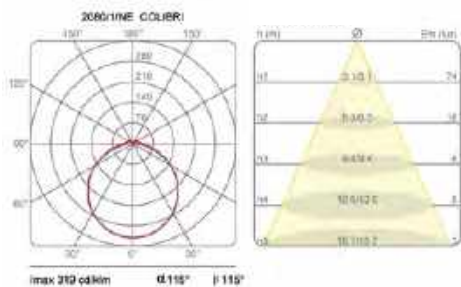

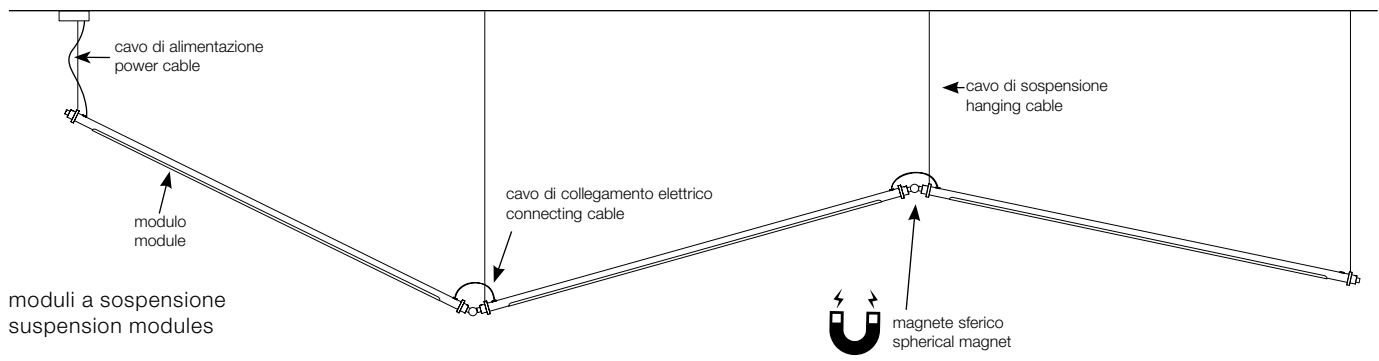

Esempio di composizione mista con cavo di sospensione e con attacchi a parete.

Example of mixed composition with suspension cable and with wall connections.

COLIBRÌ

sospensione 90° / 90° suspension

Sistema componibile a sospensione, composto da moduli lineari, orientabili, di diverse lunghezze. Luce diretta, indiretta e orientabile. Moduli in tubolare di alluminio verniciato, sorgente di luce a LED. Diffusore in policarbonato opal bianco. Il giunto angolare a 90° permette di creare configurazioni di forma quadrata e rettangolare, oltre a poter creare soluzioni libere bidimensionali e tridimensionali. Alimentatore dimmerabile inserito nel rosone da fissare al soffitto o remoto.

Modular suspension light system composed of linear adjustable modules having different lengths. Direct, indirect and adjustable light. Modules in tubular painted aluminium. LED light source, white opal polycarbonate diffuser. The 90° corner joint allows to create square or rectangular configurations, as well as creative two-dimensional and three-dimensional solutions. Dimmable driver placed in the ceiling rose or remotely.

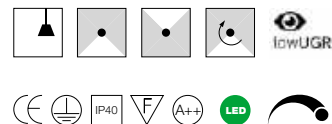

watt	flusso/flux	CCT	Kg	colore/colour	codice/code
------	-------------	-----	----	---------------	-------------

MODULI / MODULES

modulo / module 30

3,5W 24V 580lm 3000K 0,3 ● nero/black 40083/NE

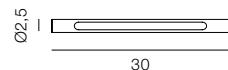

modulo / module 65

7W 24V 1150lm 3000K 0,5 ● nero/black 40082/NE

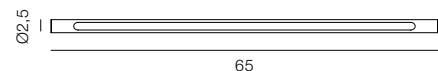

modulo / module 130

14W 24V 2300lm 3000K 1 ● nero/black 40081/NE



MODULI CIECHI DI COLLEGAMENTO / BLIND CONNECTION MODULES

modulo / module 15

modulo senza luce / module without light 0,08 ● nero/black 40115/NE



modulo / module 30

modulo senza luce / module without light 0,15 ● nero/black 40116/NE

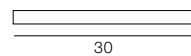

ROSONI / CEILING ROSES

120W 230/24V 1,5 ● nero/black 40085/NE

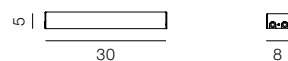

240W 230/24V 2,5 ● nero/black 40102/NE

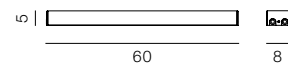

passacavo a membrana per il passaggio di più cavi di alimentazione.
membrane cable gland for multiple power cables.

alimentatori elettronici dimmerabili remoti / remote dimmable electronic drivers

75W 230/24V 1,5 40163

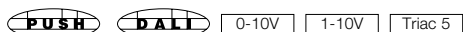

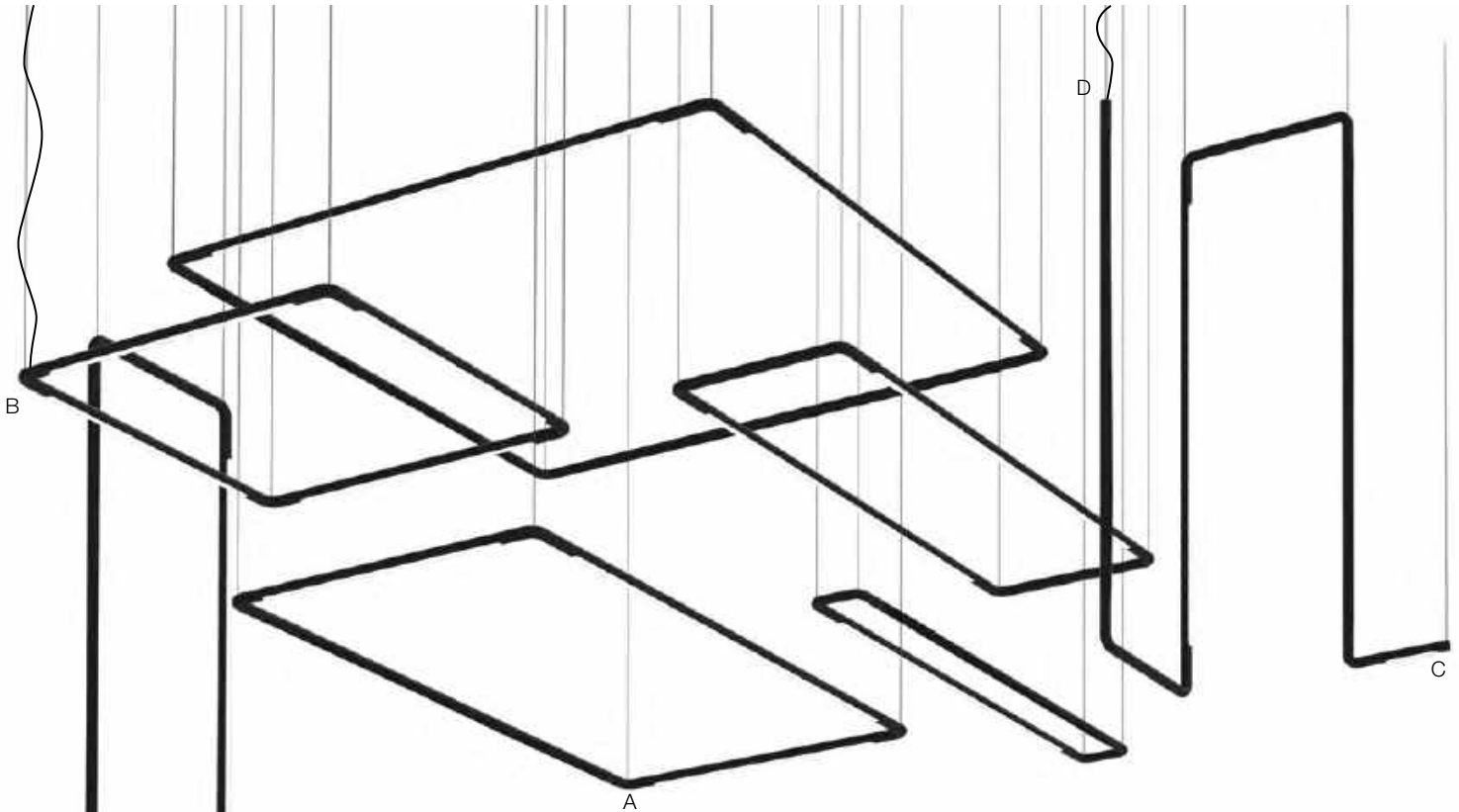

GIUNTI / JOINTS



A) giunto 90° / 90° joint



B) giunto 90° con cavo di alimentazione
90° joint with electrical cable

giunto lineare senza cavo / linear joint without cable
giunto lineare con cavo di alimentazione
linear joint with electrical cable



C) testata terminale / terminal joint

D) testata terminale con cavo di alimentazione
terminal joint with electrical cable



nero/black

40084/NE



nero/black

40117/NE



nero/black

40130/NE



nero/black

40129/NE



nero/black

40101/NE



nero/black

40118/NE

cavo di alimentazione / power cable H 350

MODULO / MODULE 130



MODULO / MODULE 65

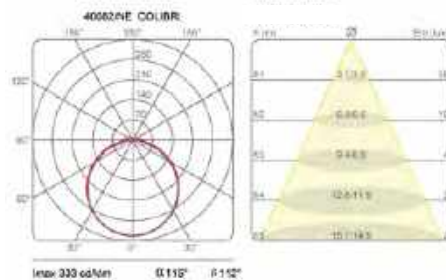

MODULO / MODULE 30

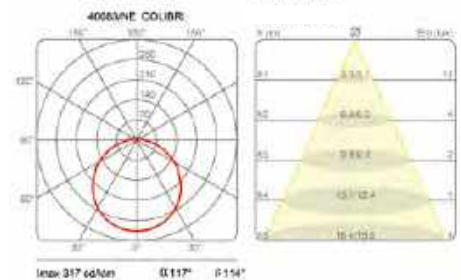

COLIBRI

parete-soffitto 90° / 90° wall-ceiling

Sistema componibile a parete, composto da moduli lineari, orientabili, di diverse lunghezze. Luce diretta, indiretta e orientabile. Moduli in tubolare di alluminio verniciato, sorgente di luce a LED. Diffusore in policarbonato opal bianco. Il giunto angolare a 90° permette di creare configurazioni di forma quadrata e rettangolare, oltre a poter creare soluzioni libere bidimensionali e tridimensionali. Alimentatore dimmerabile remoto.

Modular suspension light system composed of linear adjustable modules having different lengths. Direct, indirect and adjustable light. Modules in tubular painted aluminium. LED light source, white opal polycarbonate diffuser. The 90° corner joint allows to create square or rectangular configurations, as well as creative two-dimensional and three-dimensional solutions. Remote dimmable driver.

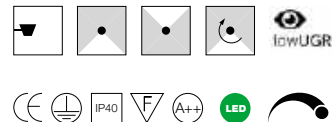

watt	flusso/flux	CCT	Kg	colore/colour	codice/code
------	-------------	-----	----	---------------	-------------

MODULI / MODULES

modulo / module 30

3,5W 24V	580lm	3000K	0,3	● nero/black	40083/NE
----------	-------	-------	-----	--------------	----------

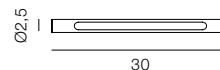

modulo / module 65

7W 24V	1150lm	3000K	0,5	● nero/black	40082/NE
--------	--------	-------	-----	--------------	----------

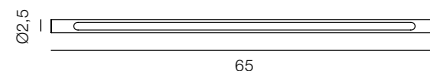

modulo / module 130

14W 24V	2300lm	3000K	1	● nero/black	40081/NE
---------	--------	-------	---	--------------	----------



GIUNTI / JOINTS

giunto 90° / 90° joint	● nero/black	40084/NE
------------------------	--------------	----------



giunto 90° con cavo di alimentazione / 90° joint with electrical cable	● nero/black	40117/NE
--	--------------	----------

attacco a parete / wall support Ø3,5 L7	● nero/black	40161/NE
---	--------------	----------



attacco a parete / wall support Ø3,5 L11	● nero/black	40162/NE
--	--------------	----------



ROSONI / CEILING ROSES

120W 230/24V	1,5	● nero/black	40085/NE
--------------	-----	--------------	----------

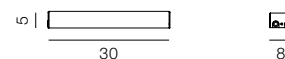

240W 230/24V	2,5	● nero/black	40102/NE
--------------	-----	--------------	----------

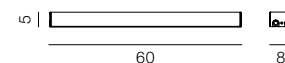

passacavo a membrana per il passaggio di più cavi di alimentazione.
membrane cable gland for multiple power cables.

alimentatori elettronici dimmerabili remoti / remote dimmable electronic drivers

75W 230/24V	1,5	40163
-------------	-----	-------



COLIBRÌ

sospensione con alimentatore integrato / suspension with integrated driver



Lampada a sospensione a luce diretta/indiretta orientabile. Struttura in alluminio anodizzato nel colore nero. Sorgente di luce a LED integrata. Alimentatore elettronico integrato nel corpo cilindrico fissato alla estremità della lampada.

Adjustable hanging lamp, direct/indirect light. Black anodized aluminium structure. Integrated LED light source. Electronic driver integrated in the cylindrical body fixed to the end of the lamp.

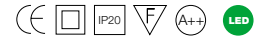

watt	flusso/flux	CCT	Kg	colore/colour	codice/code
14W 230V	2300lm	3000K	1,8	● nero/black	2087/NE

alimentatore elettronico integrato / integrated electronic driver integrated

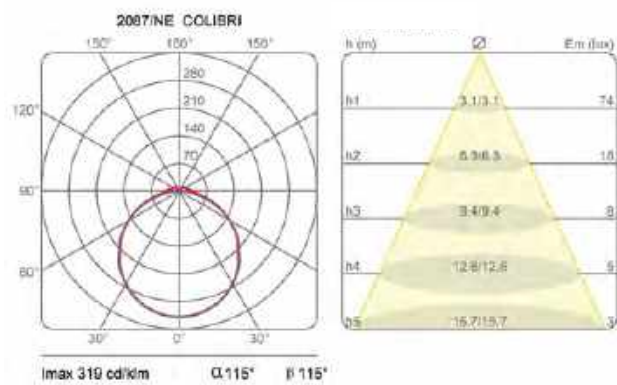
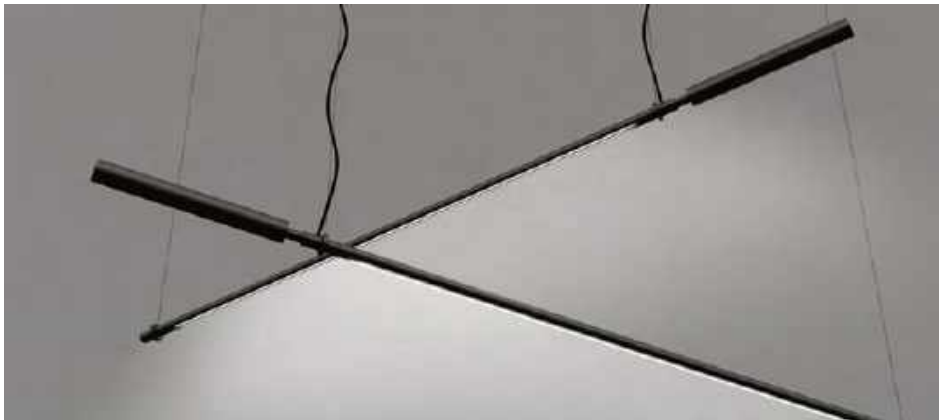
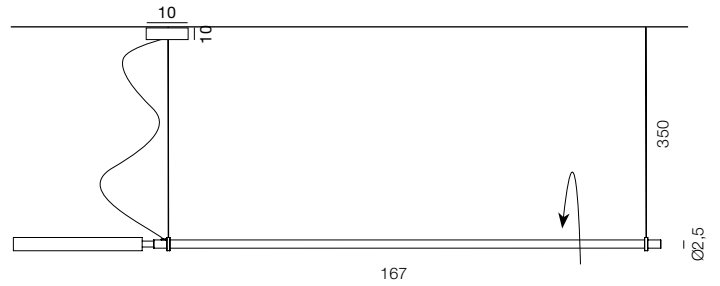



COLIBRÌ

parete con alimentatore integrato / wall with integrated driver



Lampada da parete a luce diretta/indiretta orientabile. Struttura in alluminio anodizzato nel colore nero.

Sorgente di luce a LED integrata. Alimentatore elettronico integrato nel corpo cilindrico alla estremità della lampada. Attacco diretto alla rete elettrica.

Wall lamp, adjustable direct/indirect light. Black anodized aluminium structure. Integrated LED light source.

Electronic driver integrated in the cylindrical body fixed to the end of the lamp. Direct connection to the power grid.



watt	flusso/flux	CCT	Kg	colore/colour	codice/code
14W 230V	2300lm	3000K	1,2	● nero/black	1421/NE

alimentatore elettronico integrato / integrated electronic driver integrated

disponibile su richiesta anche con cavo e spina / also available on request with cable and plug.

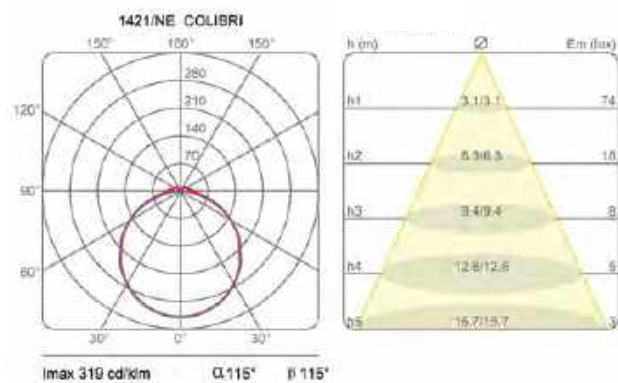
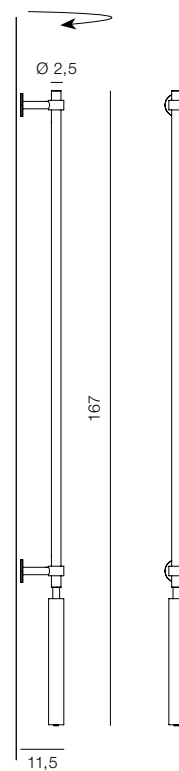



COLIBRÌ

spot sospensione / suspension spot

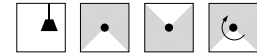

Apparecchio a sospensione a luce diretta/indiretta. Struttura in tubolare in alluminio, composto da moduli girevoli, con spots orientabili e direzionabili indipendentemente. Sorgente di luce a LED integrata, alimentatore incluso nel rosone a soffitto.

Hanging device with direct/indirect light, aluminium tubular structure, composed of rotating modules, with small independently adjustable and directable spots. Integrated LED light source, driver included in the ceiling rose.

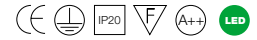

watt	fascio/beam	flusso/flux	CCT	Kg	colore/colour	codice/code
6x3W 230V	narrow	1500lm	3000K	1,2	● nero/black	2070/NE

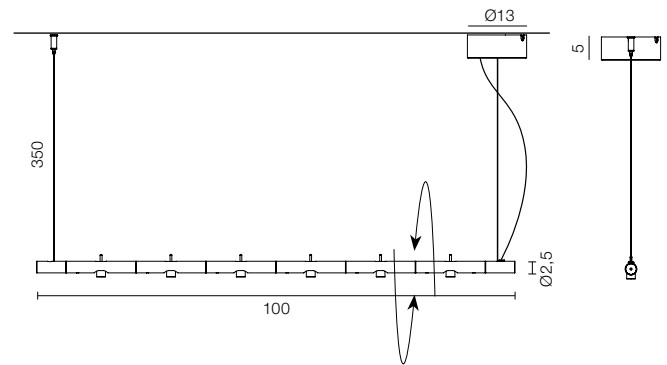

curva relativa a un singolo spot / single spot lighting curve

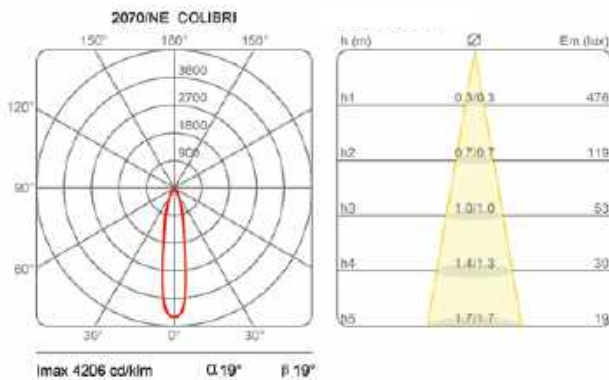



COLIBRÌ

spot a parete-soffitto / wall-ceiling spot

Apparecchio da parete girevole, a luce diretta/indiretta, con testa orientabile, struttura in tubolare di alluminio. Sorgente di luce a LED integrata. Alimentatore elettronico remoto escluso.

Adjustable wall lamp, direct/indirect light, rotating head, tubular aluminium structure. Integrated LED light source. Remote electronic driver not included.

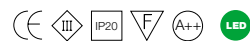

watt	fascio/beam	flusso/flux	CCT	Kg	colore/colour	codice/code
3W 500mA	narrow	250lm	3000K	0,2	● nero/black	1406/NE
alimentatore elettronico remoto / remote electronic driver 25W 230V/500mA						30811.1

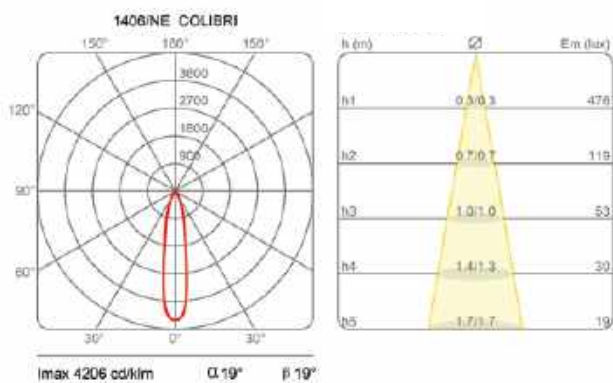
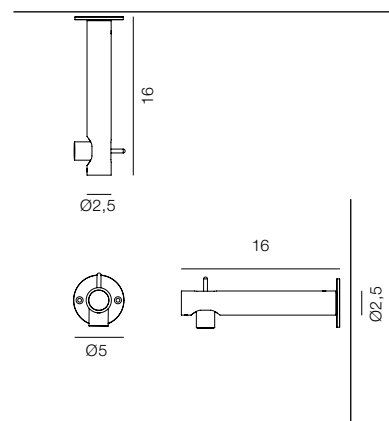



Mostra Hermès, Mito e Bellezza, Palazzo Ducale, Lucca – Napoleone ed Emile Maurice Hermès

COLIBRÌ

parete a doppia luce / double light wall

Apparecchio da parete a luce diretta/indiretta, orientabile e girevole, con base completa di alimentatore elettronico.
Struttura in tubolare di alluminio.
Sorgenti di luce a LED integrate.
Colibri senza base e con alimentatore remoto, su richiesta.

Wall device, direct/indirect adjustable and adjustable light, with base complete of electronic driver.
Tubular aluminium structure.
Integrated LED light sources.
Colibri without base and with remote driver, on request.

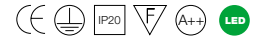

watt	flusso/flux	CCT	Kg	colore/colour	codice/code
2x10W 230V	2480lm	3000K	1,2	● nero/black	1410/B/NE
				● oro p./p. gold	1410/B/AU

alimentatore elettronico 25W integrato nella base / 25W electronic driver integrated in the base

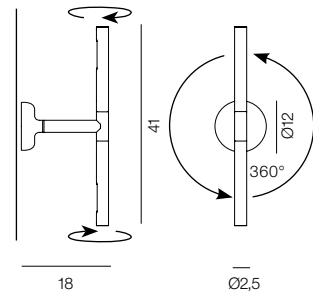

curva relativa a un singolo spot / single spot lighting curve

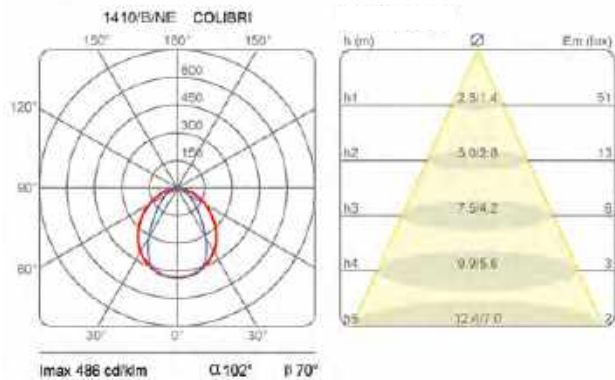





CALABRONE



Una serie di apparecchi disponibili nelle versioni a sospensione, da parete, soffitto e da terra. Un profilo in tubolare di alluminio con spots direzionabili per una luce d'accento o per una luce orientabile diffusa. Lenti intercambiabili, per ottenere diverse angolazioni del fascio di luce.

A series of light fixtures available in the suspension, wall, ceiling and floor versions. An aluminium tubular structure with adjustable spotlights, for an accentuated light or for diffused light. Interchangeable lenses, in order to obtain different angles of the light beam.

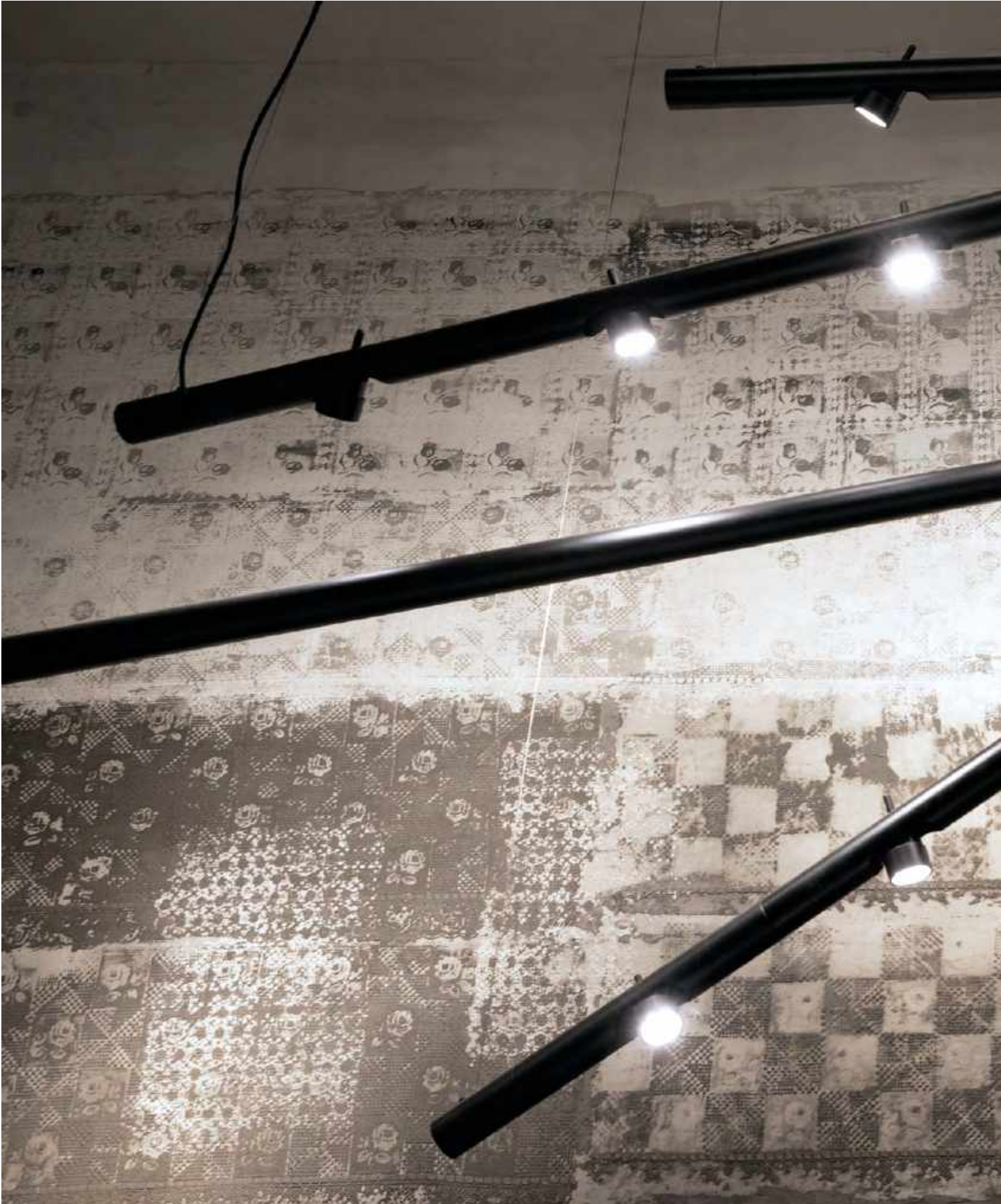

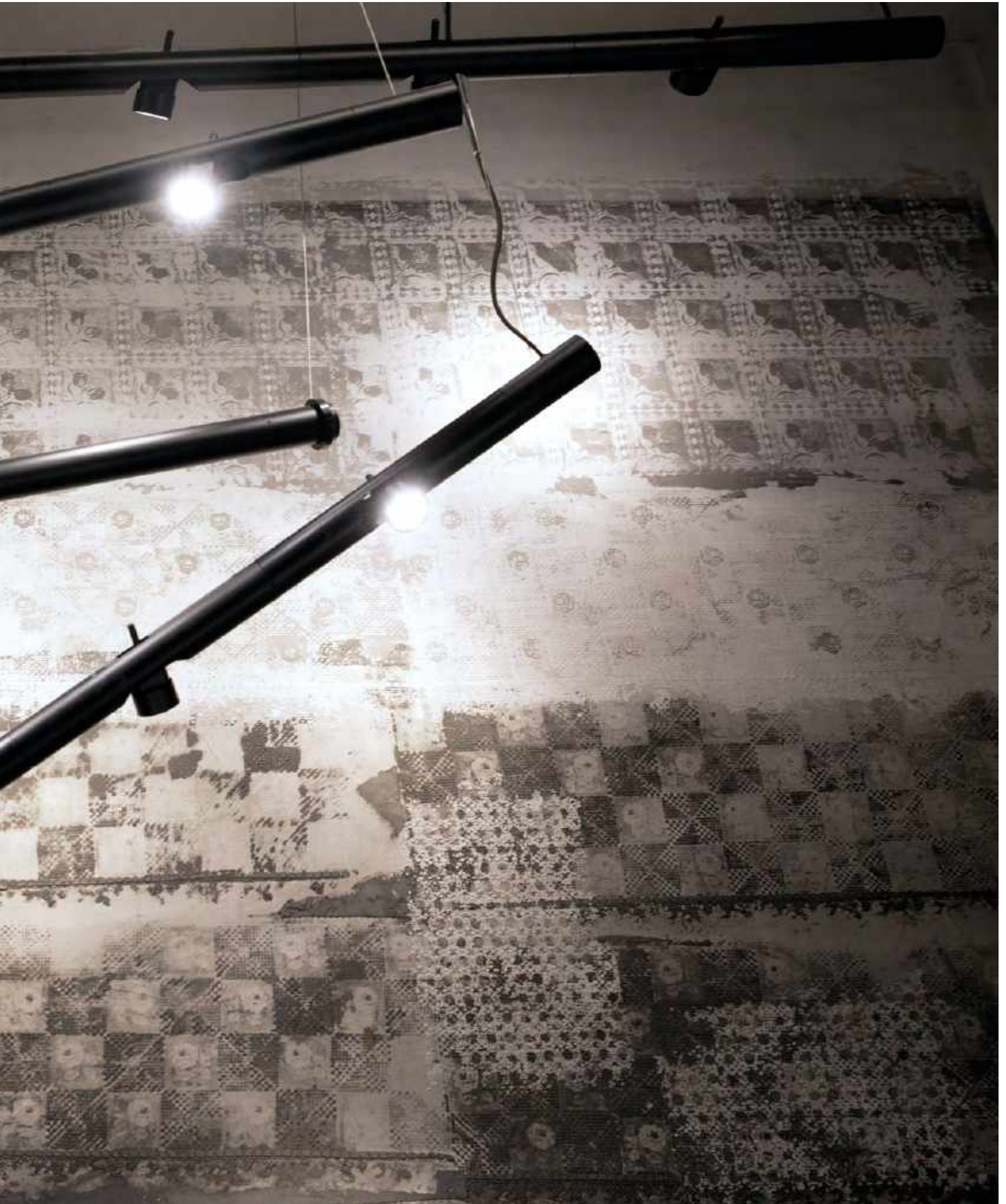



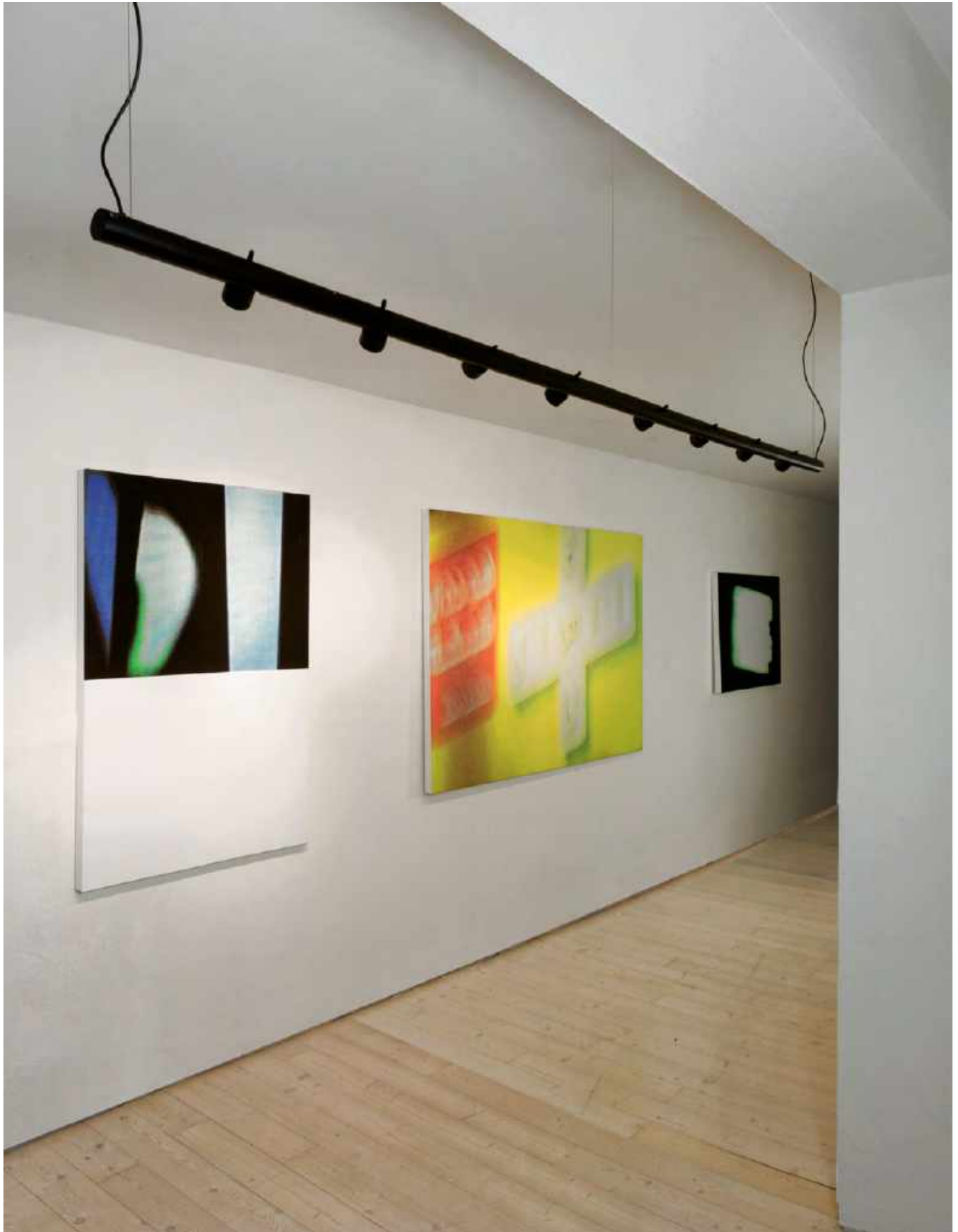









versione speciale con 6 spots / special version with 6 spots





CALABRONE

spot sospensione / suspension spot

Lampada a sospensione a luce diretta, indiretta e orientabile, formata da moduli in tubolare di alluminio girevoli, con 4/8 spots direzionabili e indipendenti, per sorgente di luce a LED. Disponibili lenti con diverse angolazioni del fascio di luce.
Struttura in alluminio verniciato nero. Disponibile un giunto lineare che consente di unire insieme due Calabrone.
Alimentatori elettronici dimmerabili inseriti nel rosone al soffitto.

Suspension lamp, direct, indirect and adjustable light, comprised of rotating tubular aluminium modules, with 4/8 adjustable and independent spotlights for LED light source. Available lenses with different angles of the light beam.
Black painted aluminium structure. A linear joint is available to join two Calabrone lamps together.
Electronic dimmable drivers placed inside the ceiling rose.

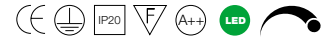
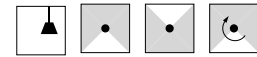

watt	fascio/beam	flusso/flux	CCT	Kg	colore/colour	codice/code
------	-------------	-------------	-----	----	---------------	-------------

CALABRONE 4 spot						
4x9W 230V	narrow	5336lm	3000K	3,5	● nero/black	2090/DIM/NE
a richiesta fascio medio e largo / medium and wide beam on request						

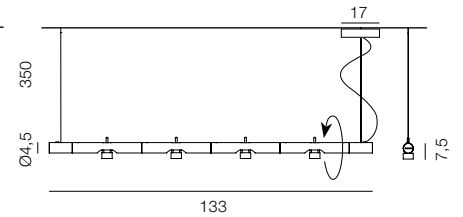

CALABRONE 8 spot						
8x9W 230V	narrow	10672lm	3000K	7	● nero/black	2090/G/DIM/NE
a richiesta fascio medio e largo / medium and wide beam on request						

a richiesta con un solo rosone centrale Ø31
on request with a single central ceiling rose Ø31

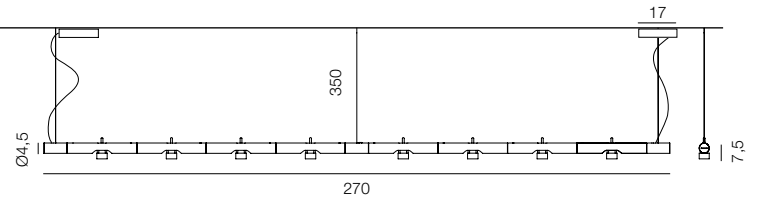

alimentatori elettronici dimmerabili nel rosone / electronic dimmable drivers

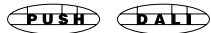

giunto meccanico / mechanical joint	● nero/black	30869/NE
-------------------------------------	--------------	----------

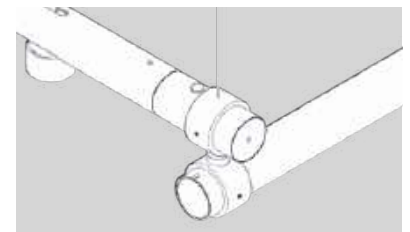
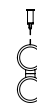

curva relativa a un singolo spot / single spot lighting curve

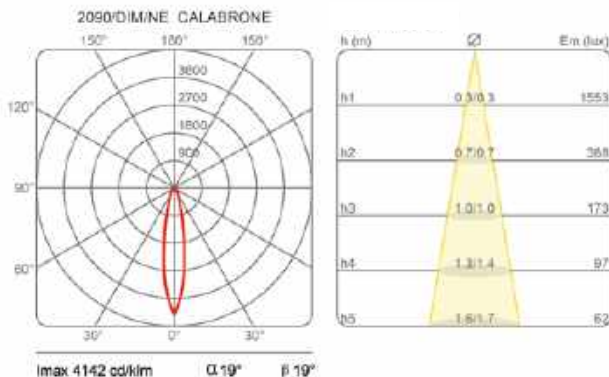



CALABRONE

sospensione / suspension

Lampada a sospensione orientabile a luce diffusa. Struttura in tubolare di alluminio verniciato nel colore nero, con asola per diffusore in policarbonato opal bianco. Giunto intermedio per unire i moduli. Sorgente di luce LED integrata.

Suspension lamp with adjustable diffused light. Black painted aluminium tubular structure. With the opal methacrylate diffuser. Intermediate joints to connect modules. Integrated LED light source.

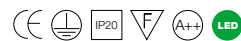

watt	CCT	Kg	colore/colour	codice/code
20W 230V	3000K	3	● nero/black	2097/NE

rosone / ceiling rose Ø23 H 3

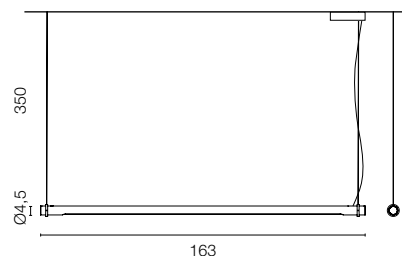

giunto meccanico / mechanical joint	● nero/black	30869/NE
-------------------------------------	--------------	----------

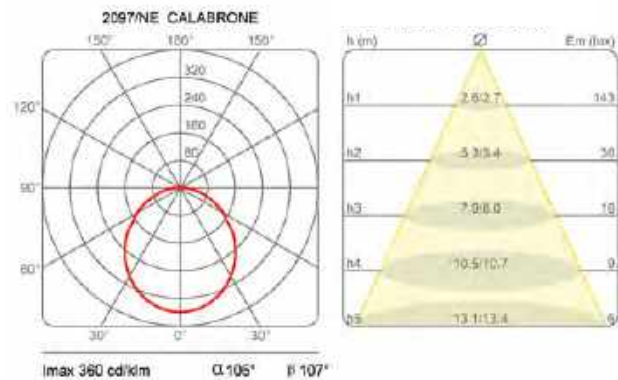
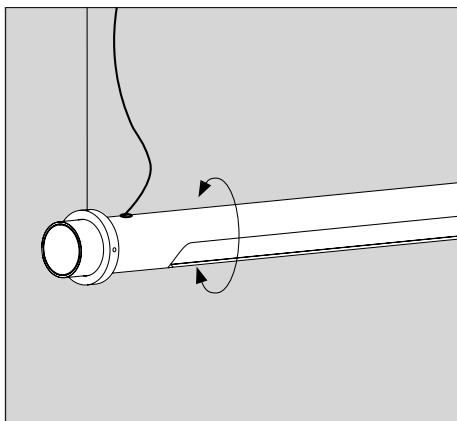
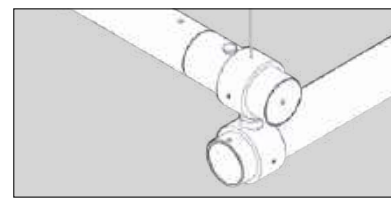
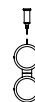

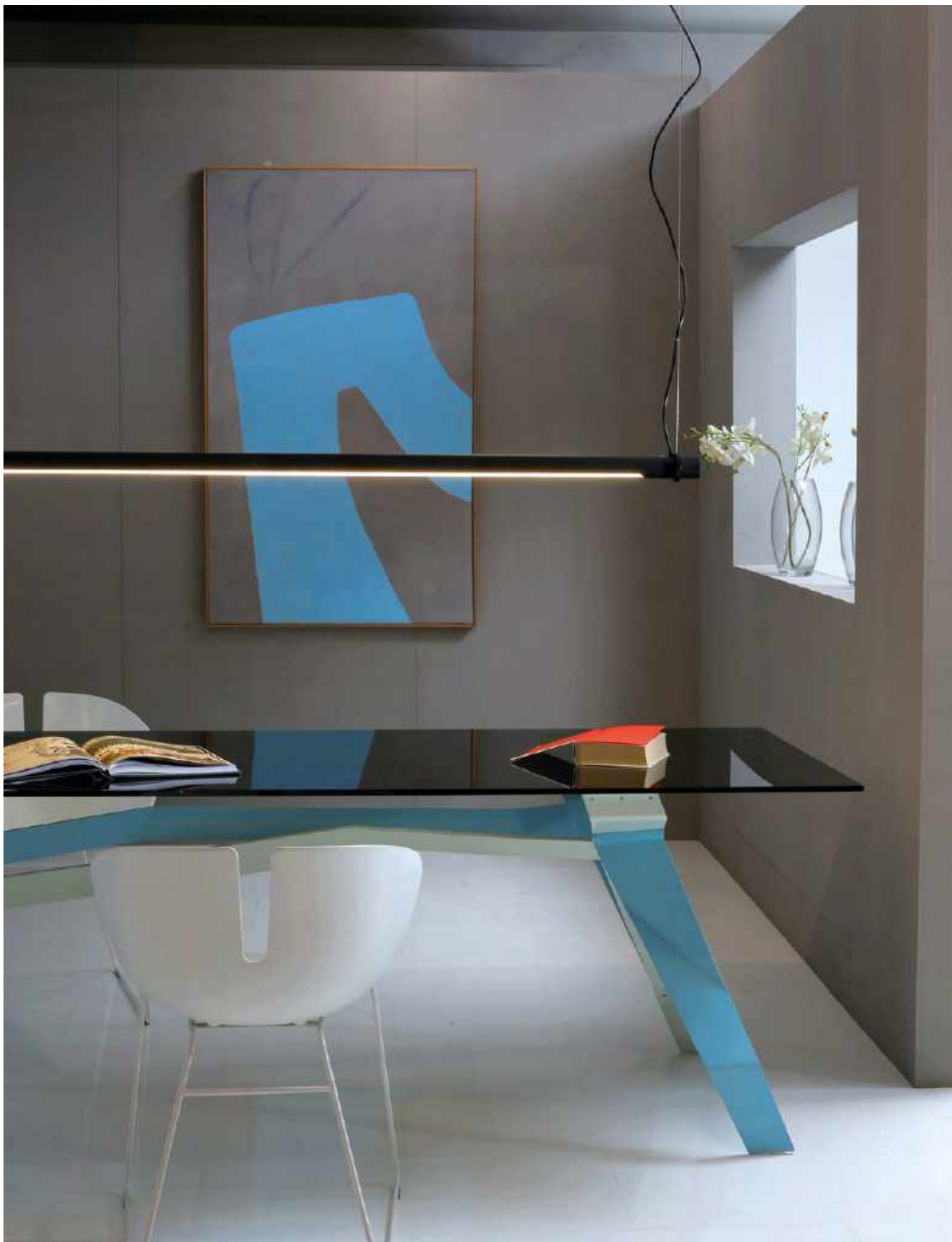

CALABRONE

spot parete-soffitto / wall-ceiling spot

Lampada da soffitto e parete a luce diretta orientabile. Struttura in tubolare di alluminio nel colore nero con spot direzionabile. Sorgente di luce a LED integrata. Disponibili lenti con diverse angolazioni del fascio di luce. Disponibile in due versioni: con alimentatore integrato o remoto.

Wall or ceiling lamp with swivel direct light. Black tubular aluminium structure with adjustable spots. Integrated LED light source. Available lenses with different angles of the light beam. Available in two versions: with integrated or remote electronic driver.

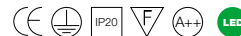

watt	fascio/beam	flusso/flux	CCT	Kg	colore/colour	codice/code
------	-------------	-------------	-----	----	---------------	-------------

1x9W 230V	medium	1334lm	3000K	2,5	● nero/black	1433/NE
-----------	--------	--------	-------	-----	--------------	---------

a richiesta fascio stretto e largo / narrow and wide beam on request

alimentatore elettronico integrato / integrated electronic driver

1x9W 230V	medium	1334lm	3000K	2,5	● nero/black	1433/J/NE
-----------	--------	--------	-------	-----	--------------	-----------

a richiesta fascio stretto e largo / narrow and wide beam on request

alimentatore elettronico remoto / remote electronic driver

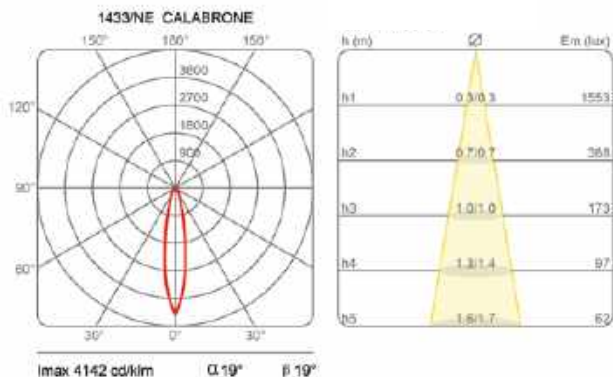
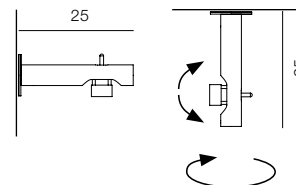
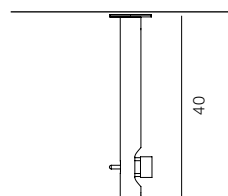



CALABRONE

terra / floor



Lampada da terra a luce diretta orientabile.
 Struttura in alluminio verniciato nel colore nero, composta da moduli girevoli, con 3 spots direzionabili e indipendenti.
 Sorgente di luce a LED integrata.
 Disponibili lenti con diverse angolazioni del fascio di luce.
 Alimentatore elettronico integrato.

Standing lamp with swivel direct light.
 Black aluminium structure, composed of rotating modules with 3 adjustable and independent spots.
 Integrated LED light source.
 Available lenses with different angles of the light beam.
 Integrated electronic driver.

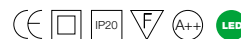

watt	fascio/beam	flusso/flux	CCT	Kg	colore/colour	codice/code
3x9W 230V	medium	3x1334lm	3000K	10	● nero/black	2293/3/NE
a richiesta fascio stretto e largo / narrow and wide beam on request						

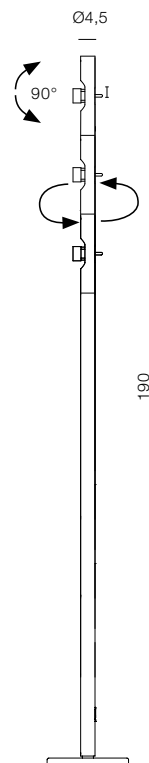
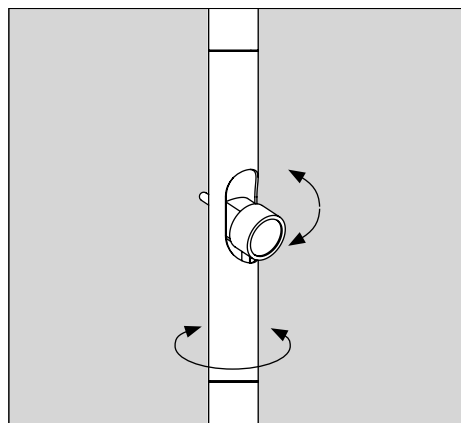

curva relativa a un singolo spot / single spot lighting curve

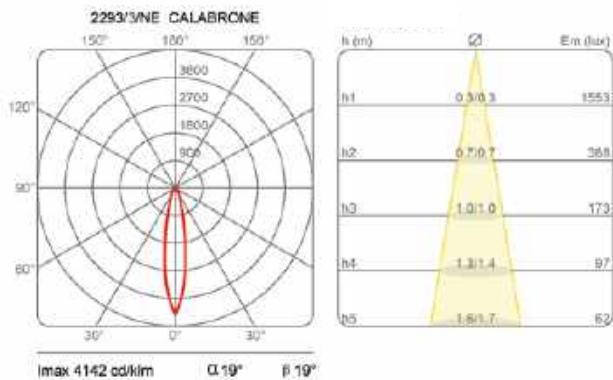

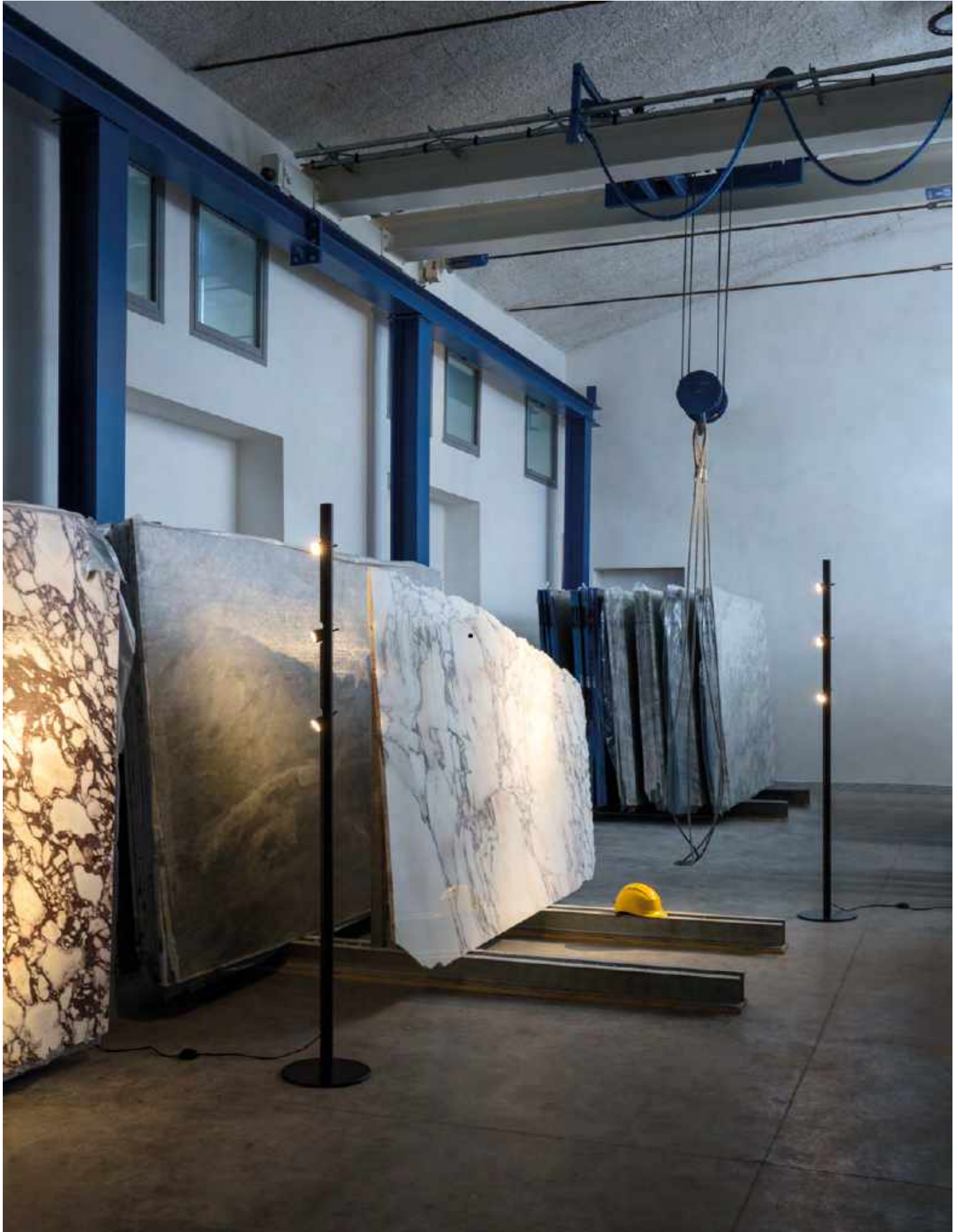



CALABRONET



Un sistema che fa della componibilità la sua specificità. Calabronet è composto da profili tubolari con spots orientabili per una luce d'accento e da profili con asola e diffusore in metacrilato per una luce diffusa. Dei giunti permettono il loro collegamento e la possibilità di ottenere varie composizioni, figure esagonali e percorsi lineari e reticolari.

A lighting system that makes modularity its characteristic trait. Calabronet consist of tubular profiles with swivel spotlights for an accent light, and elements featuring a slit and a methacrylate diffuser for a diffused light. Joints allow to connect them together, giving rise to several different compositions, hexagonal shapes and linear and lattices patterns.

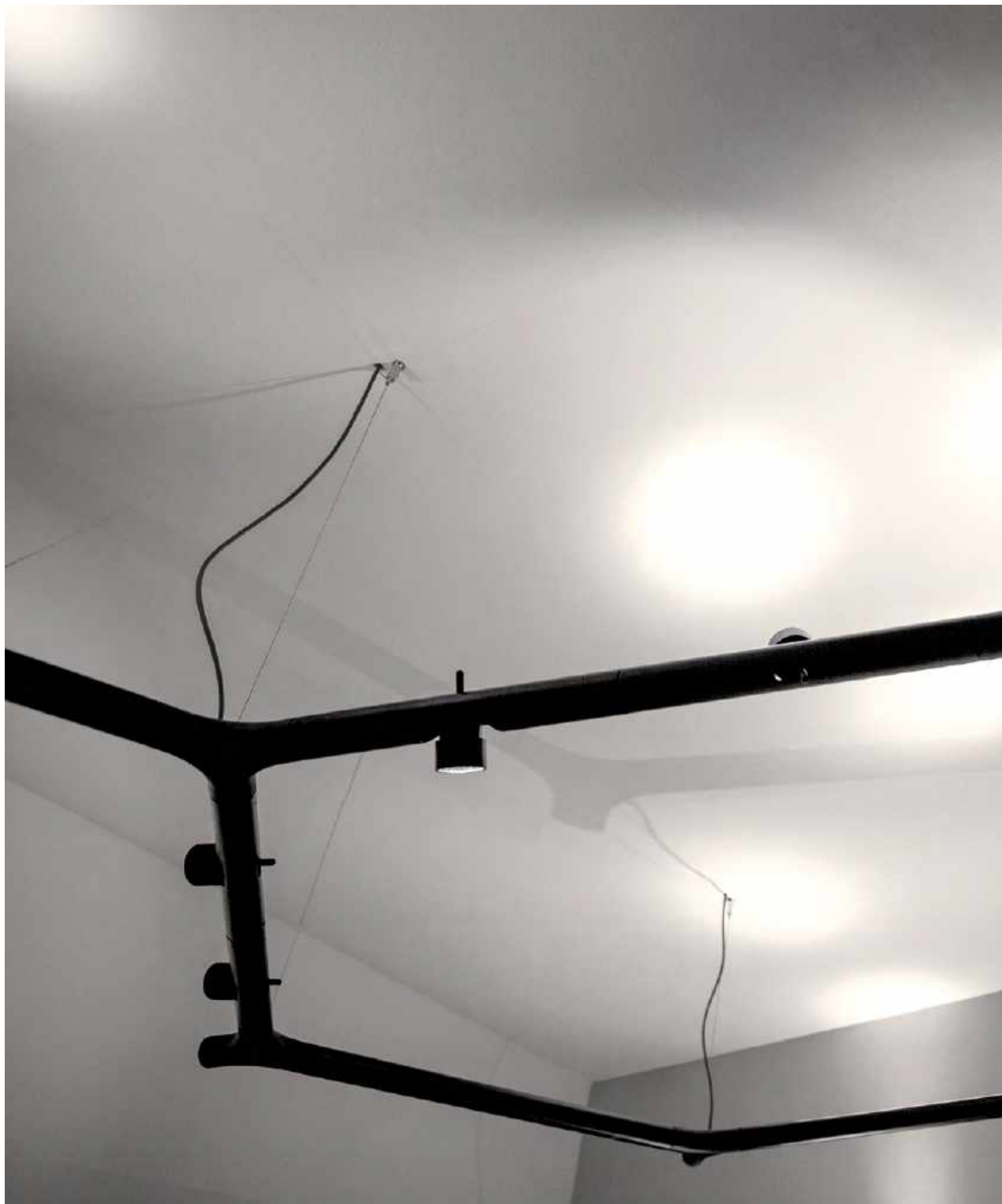











CALABRONET



Sistema componibile a luce diretta/indiretta, diffusa e orientabile. Composto da moduli tubolari in alluminio in due lunghezze, uniti tra loro con particolari giunti.

Disponibile in due versioni: per LED 8W/20W (40030/NE – 40031/NE) per una luce diffusa, o nella variante (40033/NE) con spots orientabili e indipendenti, per sorgente di luce a LED integrata. Disponibili lenti con diverse angolazioni del fascio di luce. Alimentatore elettronico all'interno del rosone a soffitto, o da inserire nel controsoffitto.

Combinable swivel system with direct/indirect diffused light. Composed of two lengths of aluminium tubular profiles connected together with a particular joints.

Available in two versions: for 8W/20W LED (40030/NE – 40031/NE) for a diffused light, or in the version (40033/NE) with adjustable and independent spots for integrated LED light source. Available lenses with different angles of the light beam and an electronic driver placed inside the ceiling rose, to be fixed to the ceiling or placed inside a false ceiling.

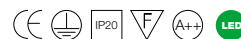

watt	fascio/beam	flusso/flux	CCT	Kg	colore/colour	codice/code
------	-------------	-------------	-----	----	---------------	-------------

MODULO A LUCE DIFFUSA / DIFFUSED LIGHT MODULE 70

8W 24V		1100 lm	3000K	1,3	● nero/black	40030/NE
--------	--	---------	-------	-----	--------------	----------

MODULO A LUCE DIFFUSA / DIFFUSED LIGHT MODULE 160

20W 24V		2900 lm	3000K	1,5	● nero/black	40031/NE
---------	--	---------	-------	-----	--------------	----------

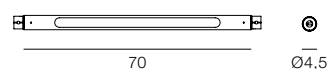
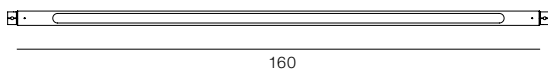

MODULO SPOT / SPOT MODULE 70

2x9W 24V	medium	2668lm	3000K	1,3	● nero/black	40033/NE
----------	--------	--------	-------	-----	--------------	----------

MODULO SPOT / SPOT MODULE 160

4x9W 24V	medium	5336lm	3000K	2,5	● nero/black	40137/NE
----------	--------	--------	-------	-----	--------------	----------

a richiesta fascio stretto e largo/ narrow and wide beam on request

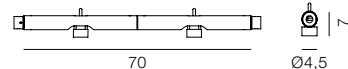
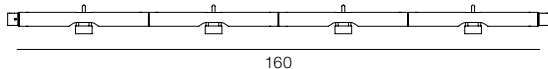

COMPONENTI / COMPONENTS

giunto 120° / 120° joint (A) con cavo di alimentazione / with power cable	0,2	● nero/black	40032/NE
--	-----	--------------	----------



giunto 90° / 90° joint (B)	0,2	● nero/black	40052/NE
----------------------------	-----	--------------	----------



giunto intermedio / intermediate joint (C)	0,2	● nero/black	40049/NE
--	-----	--------------	----------



testata di chiusura / closed head		● nero/black	40034/NE
-----------------------------------	--	--------------	----------



terminale con testata di chiusura e cavo di sospensione terminal with closed head and hanging cable		● nero/black	40037/NE
--	--	--------------	----------



cavo di alimentazione / power cable 350cm

Esempio di composizione libera con l'utilizzo dei moduli LED a luce diffusa orientabile e con spot direzionabili per una luce d'accento, uniti con il particolare giunto a 120°- 40032/NE.

Free composition example with the use of LED modules with swivel diffused light and adjustable spotlights for an accent light, connected with a special 120° joint – 40032/NE.

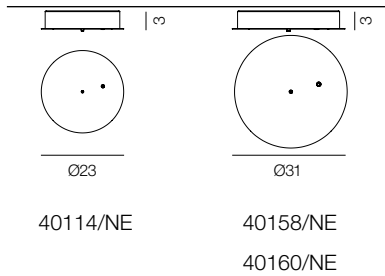
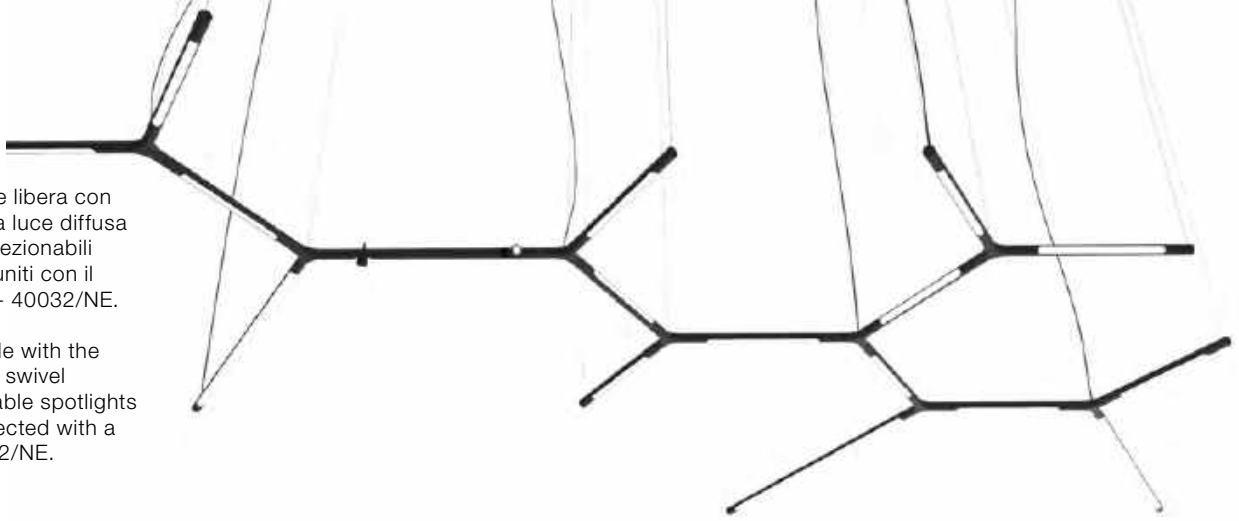

watt colore/colour codice/code

ROSONI / CEILING ROSES

rosone con alimentatore non dimmerabile / ceiling rose with non dimmable driver

50W 230/24V	● nero/black	40036/NE
75W 230/24V	● nero/black	40114/NE
150W 230/24V	● nero/black	40158/NE
240W 230/24V	● nero/black	40160/NE

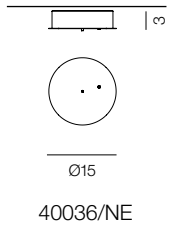

cavo di alimentazione / power cable L 350cm

La scelta del codice del rosone nelle diverse composizioni è legato alla somma dei Watt dei singoli moduli, a luce diffusa e a spot.

The choice of the ceiling rose code in the different compositions is related to the sum of the watts of the different spot modules with diffused light.

Esempio di composizione libera con l'utilizzo dei moduli LED a luce diffusa orientabile e con spot direzionabili, uniti con i diversi giunti (A,B,C).

Free composition examples with the use of LED modules with swivel diffused light and adjustable spotlights connected with a different joints (A,B,C).



alimentatori elettronici dimmerabili a richiesta / electronic dimmable drivers on request

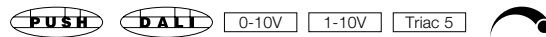

curva relativa a un singolo spot
single spot lighting curve

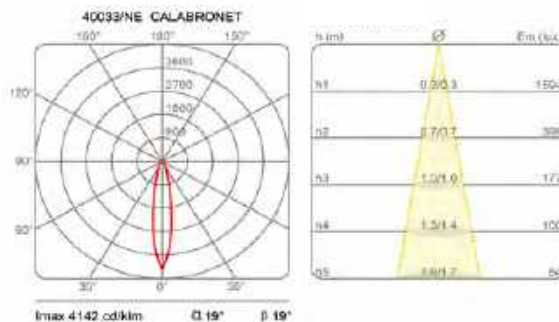



SHANGHAI

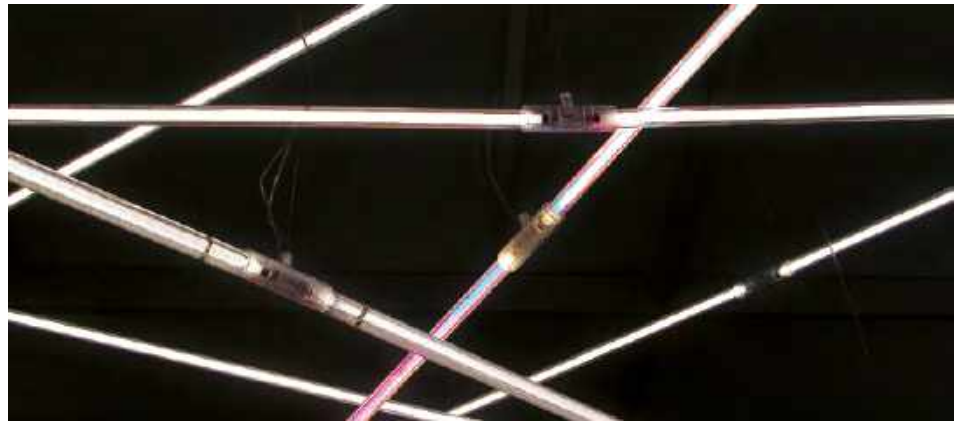

Il sistema Shanghai nasce dal desiderio di giocare con la luce nello spazio. Con pochi e semplici elementi realizzati in policarbonato, per la versione a sospensione o a parete, e un tubo fluorescente o a led, è possibile comporre molteplici combinazioni luminose all'interno dei diversi spazi architettonici. La semplicità del sistema e la sua informalità trasmettono freschezza e dinamicità.

The Shanghai lighting system comes from the desire to play with light in space. With just a few simple elements in polycarbonate for the suspension or wall version, and a fluorescent or LED tube, it is possible to create many light combinations within different architectural environments. The simplicity of the system and its informality transmit freshness and dynamism.

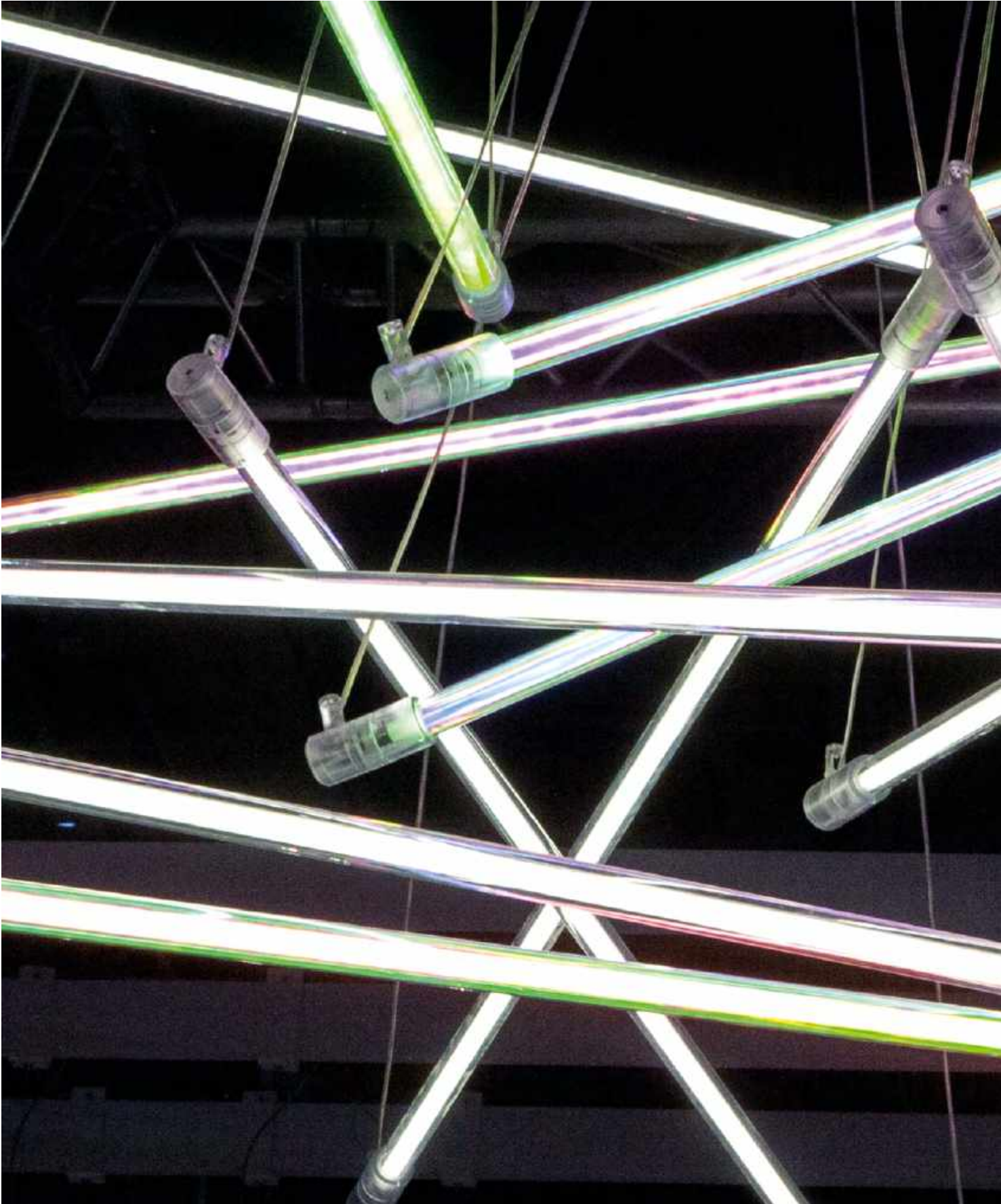

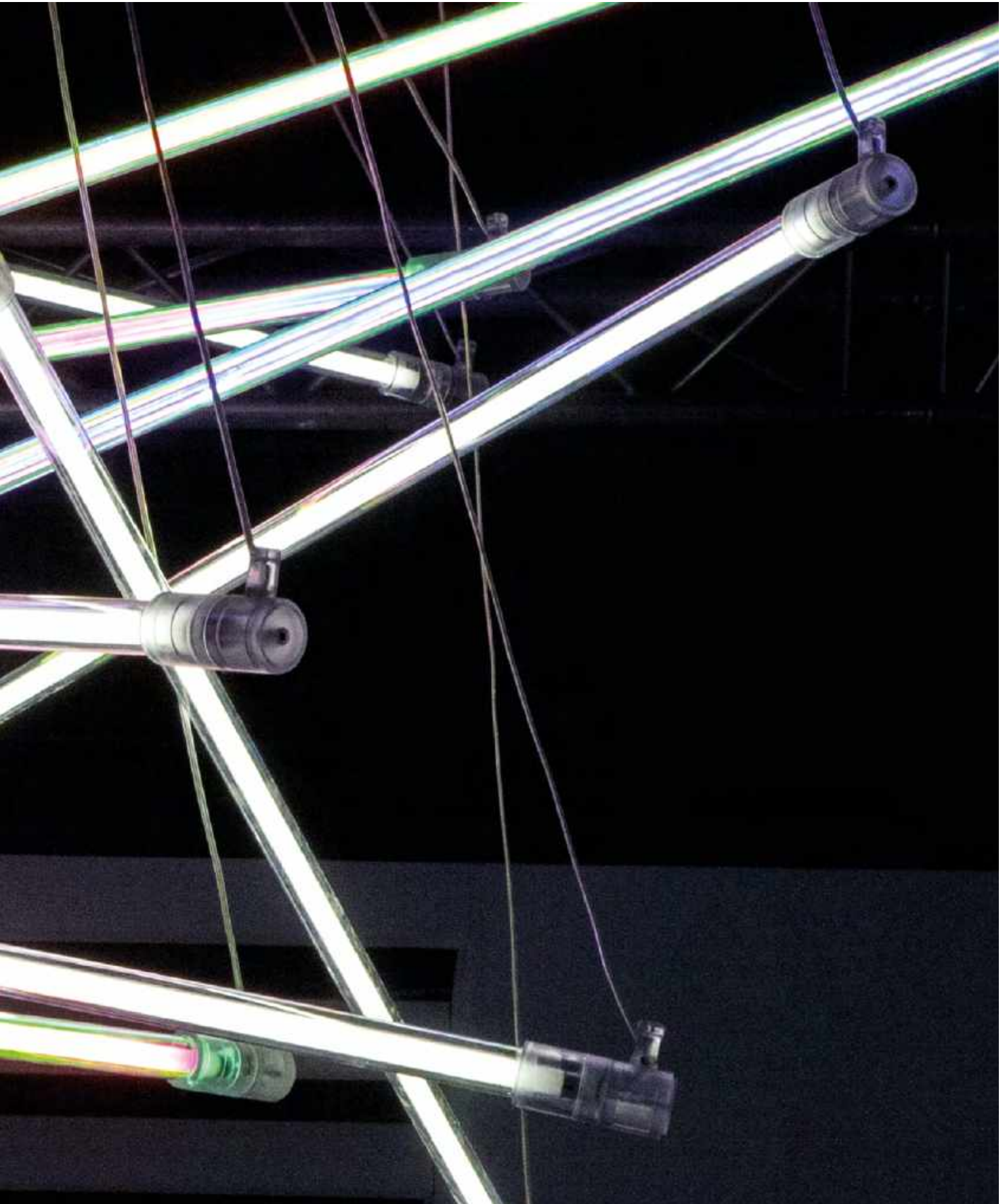



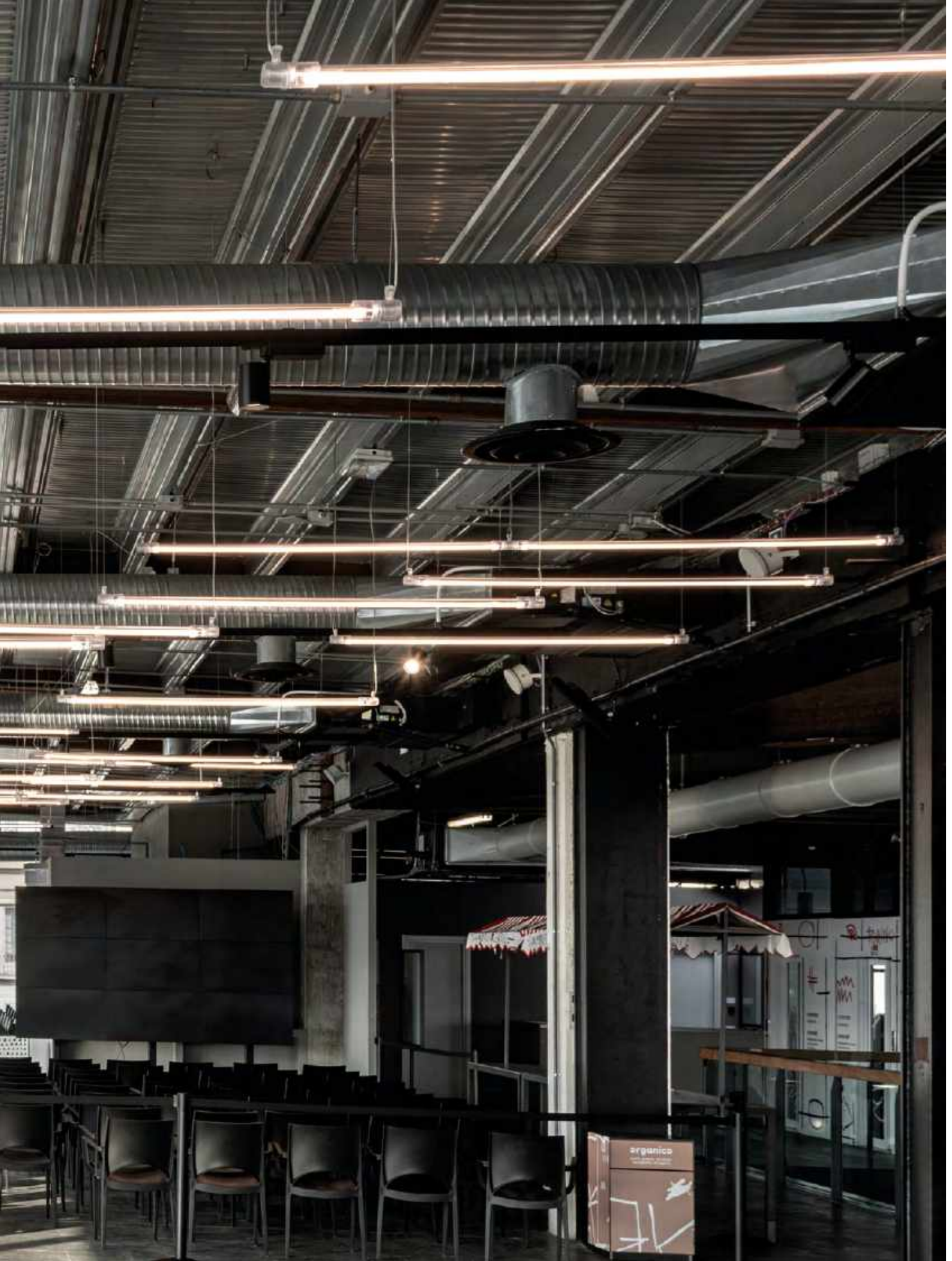

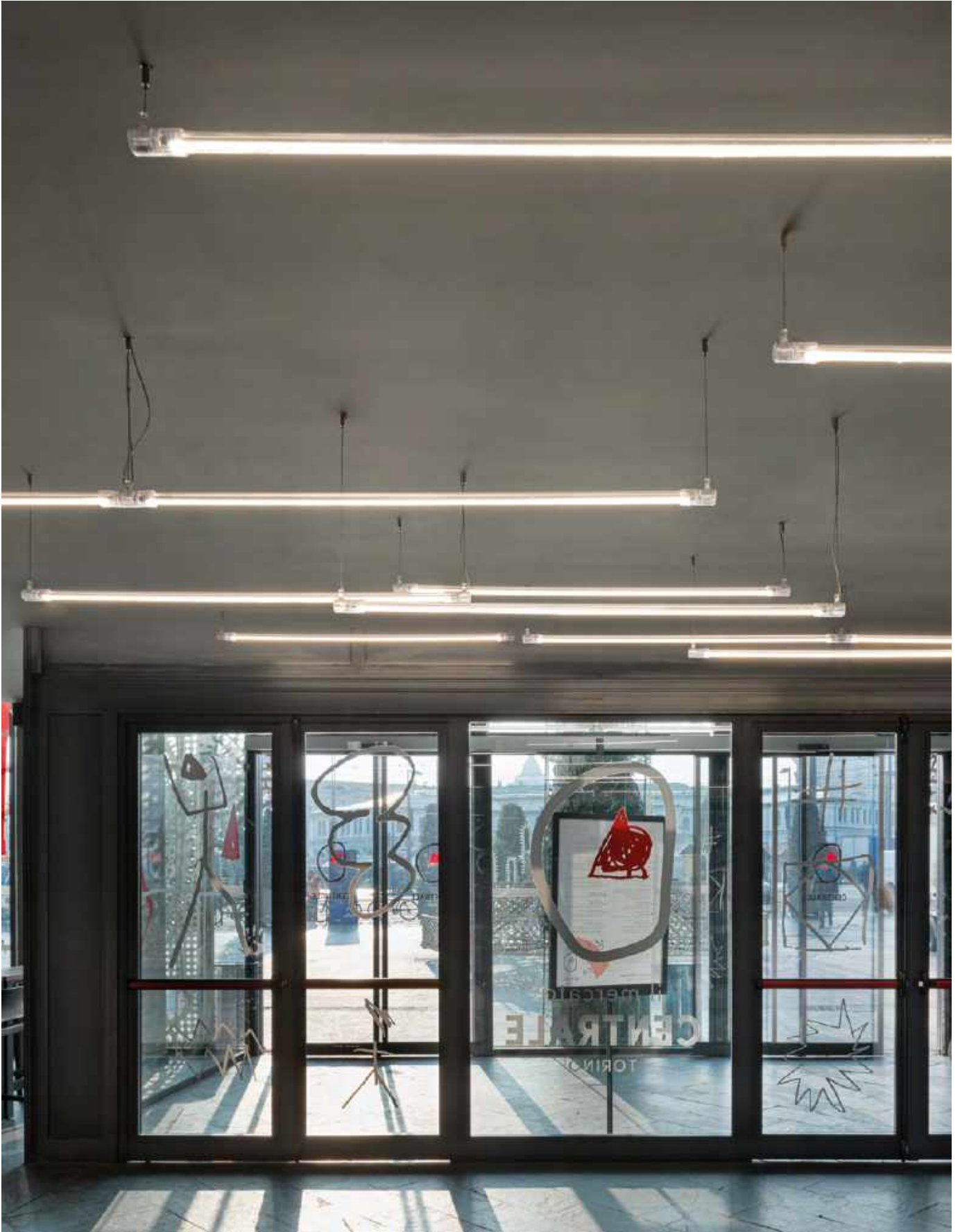

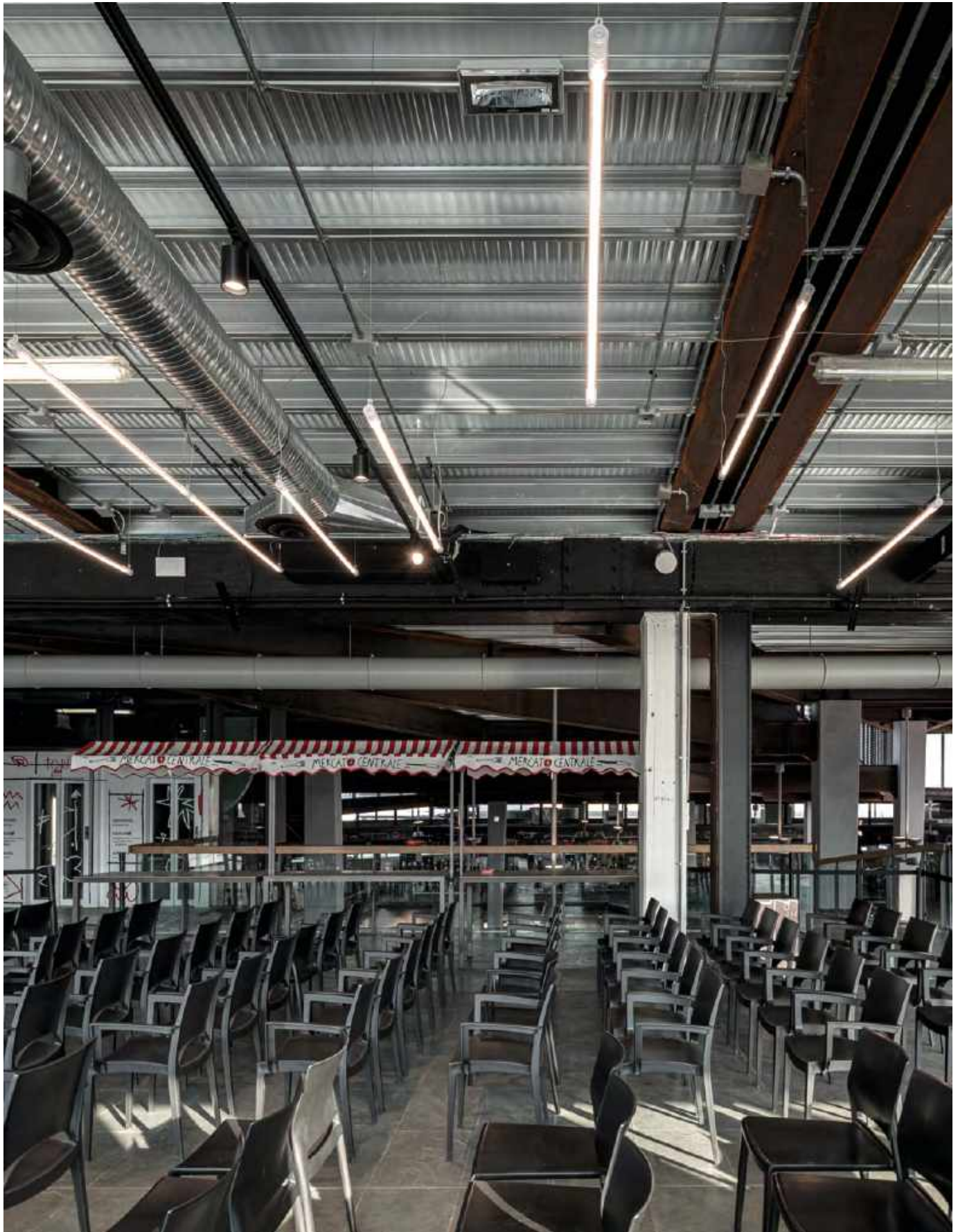





Liceo Musicale A. Passaglia – S. Agostino, Lucca – arch. Fabrizio Mechini, Francesca Lazzari

SHANGHAI

sospensione / suspension



Sistema componibile a luce diffusa per tubi fluorescenti o a LED. Realizzato con elementi tubolari in policarbonato trasparente uniti con giunti terminali e intermedi in policarbonato bianco o trasparente. I giunti sono completi di cavo in acciaio e di cavo di alimentazione da collegare all'alimentatore cablato all'interno del rosone in alluminio verniciato da fissare al soffitto.

Modular diffuse lighting system for fluorescent or LED tubes. It is made of tubular transparent polycarbonate elements connected by terminal or intermediate joints, made of white or transparent polycarbonate. Joints complete of stainless cables and power cables to be connected to the driver inside the painted aluminium ceiling rose.



watt	colore/colour	codice/code
------	---------------	-------------

GIUNTO TERMINALE / TERMINAL JOINT (GF)

per tubo fluorescente o LED con cavo di alimentazione L 250 cm
for fluorescent or LED tube with power cable

- | | | |
|--------------------------|--|---------|
| 1x49W FL - 20W LED G5 T5 | <input type="radio"/> bianco/white | 30642 |
| | <input checked="" type="radio"/> trasparente/transparent | 30642/T |

per tubo LED senza cavo di alimentazione
for LED tube without power cable

- | | | |
|-----------------|--|-----------|
| 1x20W LED G5 T5 | <input type="radio"/> bianco/white | 30642.1 |
| | <input checked="" type="radio"/> trasparente/transparent | 30642.1/T |



GIUNTO INTERMEDIO / INTERMEDIATE JOINT (GI)

per tubo fluorescente o LED con cavo di alimentazione L 250 cm
for fluorescent or LED tube with power cable

- | | | |
|--------------------------|--|---------|
| 2x49W FL - 20W LED G5 T5 | <input type="radio"/> bianco/white | 30640 |
| | <input checked="" type="radio"/> trasparente/transparent | 30640/T |

per tubo LED senza cavo di alimentazione
for LED tube without power cable

- | | | |
|-----------|--|-----------|
| 2x20W LED | <input type="radio"/> bianco/white | 30640.1 |
| | <input checked="" type="radio"/> trasparente/transparent | 30640.1/T |



TUBO PER IL COLLEGAMENTO DEI GIUNTI / TUBE FOR THE CONNECTION OF JOINTS (T)

tubo in policarbonato trasparente con attacco per collegare i giunti terminali e intermedi.
transparent polycarbonate tube with support for connection of terminal and intermediate joints.

- | | |
|--|-------|
| <input checked="" type="radio"/> trasparente/transparent | 30647 |
|--|-------|

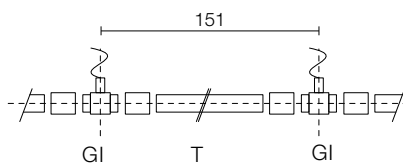
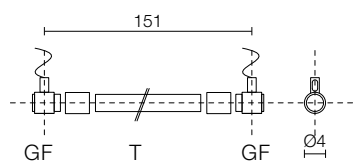

SHANGHAI

sospensione / suspension

ESEMPI / EXAMPLES

CONFIGURAZIONE SINGOLA / SINGLE CONFIGURATION

1 TUBO FLUORESCENTE / 1 FLUORESCENT TUBE

- Y 1 gruppo d'alimentazione / complete driver group
30644/J/BI - 30644/DIM/BI
- GF 2 giunti finali per T5 / terminal joints for T5
30642 (30642/T)
- T 1 tubo in policarbonato / polycarbonate tube
30647
- W2 2 cavi d'alimentazione / electrical wires

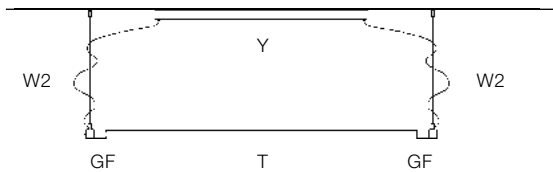

CONFIGURAZIONE DOPPIA / DOUBLE CONFIGURATION

2 TUBI FLUORESCENTI / 2 FLUORESCENT TUBES

- Y 1 gruppo d'alimentazione / complete driver group
30645/J/BI - 30645/DIM/BI
- GF 2 giunti finali per T5 / terminal joints for T5
30642 (30642/T)
- GI 1 giunto intermedio per T5 / intermediate joint for T5
30640 (30640/T)
- T 2 tubi in policarbonato / polycarbonate tubes
30647
- W2 4 cavi d'alimentazione / electrical wires

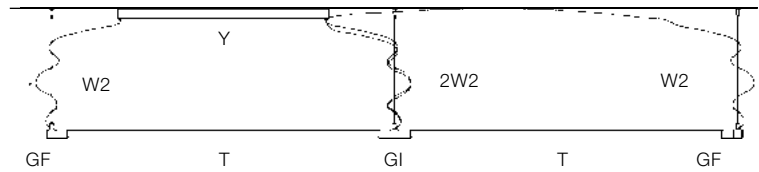

1 TUBO LED / 1 LED TUBE

- Y 1 rosone / ceiling rose
30721
- GF 2 giunti finali per T5 / joints terminals for T5
30642+30642.1 (30642/T+30642.1/T)
- T 1 tubo in policarbonato / polycarbonate tube
30647
- W2 1 cavi d'alimentazione / electrical wires

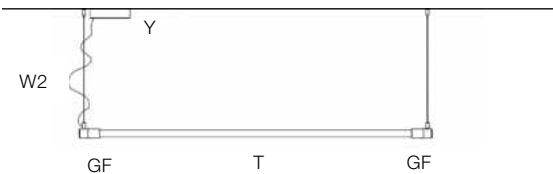

2 TUBI LED / 2 LED TUBES

- Y 1 rosone / ceiling rose
30721
- GF 2 giunti finali per T5 / terminal joints for T5
30642.1 (30642.1/T)
- GI 1 giunto intermedio per T5 / intermediate joint for T5
30640 (30640/T)
- T 2 tubi in policarbonato / polycarbonate tubes
30647
- W2 1 cavi d'alimentazione / electrical wires

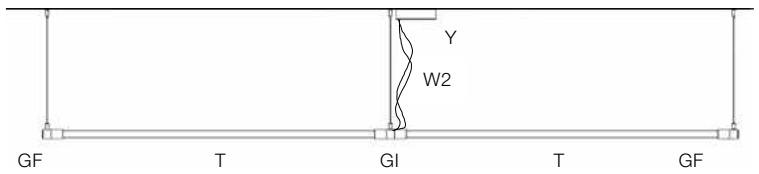

SHANGHAI

parete - soffitto / wall - ceiling

Sistema componibile a luce diffusa per tubi fluorescenti o a LED. Realizzato con elementi tubolari in policarbonato trasparente uniti con giunti terminali e intermedi in policarbonato bianco o trasparente, con supporto e basetta per il fissaggio a parete o soffitto. Alimentatore remoto.

Modular diffuse lighting system for fluorescent or LED tubes. It is made of tubular transparent polycarbonate elements connected by terminal or intermediate joints, made of white or transparent polycarbonate, with support and base for wall or ceiling mounting. Remote driver.

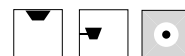

watt	colore/colour	codice/code
------	---------------	-------------

GIUNTO TERMINALE / TERMINAL JOINT (GF)

per tubo fluorescente o LED con cavo di alimentazione L 150 cm
for fluorescent or LED tube with power cable

- | | | |
|--------------------------|--|---------|
| 1x49W FL - 20W LED G5 T5 | <input type="radio"/> bianco/white | 30728 |
| | <input checked="" type="radio"/> trasparente/transparent | 30728/T |

per tubo LED senza cavo di alimentazione
for LED tube without power cable

- | | | |
|-----------------|--|-----------|
| 1x20W LED G5 T5 | <input type="radio"/> bianco/white | 30728.1 |
| | <input checked="" type="radio"/> trasparente/transparent | 30728.1/T |



GIUNTO INTERMEDIO / INTERMEDIATE JOINT (GI)

per tubo fluorescente o LED con cavo di alimentazione L 150 cm
for fluorescent or LED tube with power cable

- | | | |
|--------------------------|--|---------|
| 2x49W FL - 20W LED G5 T5 | <input type="radio"/> bianco/white | 30729 |
| | <input checked="" type="radio"/> trasparente/transparent | 30729/T |

per tubo LED senza cavo di alimentazione
for LED tube without power cable

- | | | |
|-----------|--|-----------|
| 2x20W LED | <input type="radio"/> bianco/white | 30729.1 |
| | <input checked="" type="radio"/> trasparente/transparent | 30729.1/T |

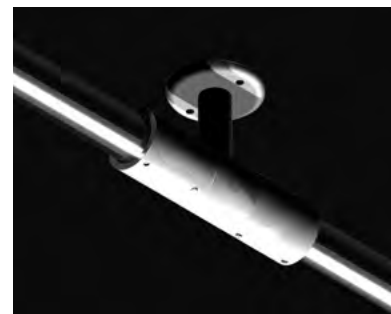

TUBO PER IL COLLEGAMENTO DEI GIUNTI / TUBE FOR THE CONNECTION OF JOINTS (T)

tubo in policarbonato trasparente con attacco per collegare i giunti terminali e intermedi.
transparent polycarbonate tube with connection support to connect terminal and intermediate joints.

- | | |
|--|-------|
| <input checked="" type="radio"/> trasparente/transparent | 30647 |
|--|-------|

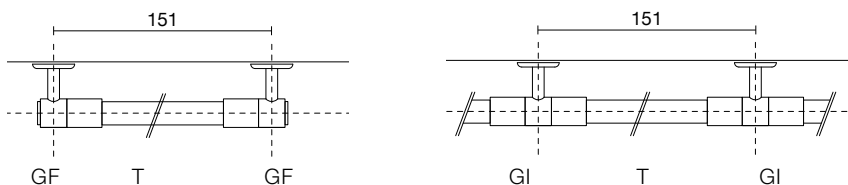

SHANGHAI

parete - soffitto / wall - ceiling

ESEMPI / EXAMPLES

CONFIGURAZIONE SINGOLA / SINGLE CONFIGURATION

1 TUBO FLUORESCENTE / 1 FLUORESCENT TUBE

- 1 gruppo d'alimentazione remoto
remote power supply
30645/J/BI - 30645/DIM/BI
- GF 2 giunti finali per T5 / joints terminals for T5
30728 (30728/T)
- T 1 tubo in policarbonato / polycarbonate tube
30647

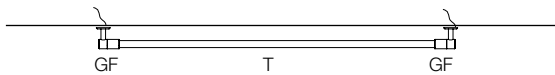

CONFIGURAZIONE DOPPIA / DOUBLE CONFIGURATION

2 TUBI FLUORESCENTI / 2 FLUORESCENT TUBES

- 1 gruppo d'alimentazione remoto
remote power supply
30645/J/BI - 30645/DIM/BI
- GF 2 giunti finali per T5 / terminal joints for T5
30728 (30728/T)
- GI 1 giunto intermedio per T5 / intermediate joint for T5
30729 (30729/T)
- T 2 tubi in policarbonato / polycarbonate tubes
30647

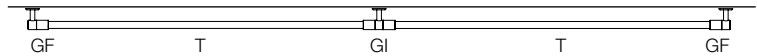

1 TUBO LED / 1 LED TUBE

- 1 gruppo d'alimentazione remoto
remote power supply
30721
- GF 2 giunti finali per T5 / terminal joints for T5
30728 + 30728.1
o
(30728/T + 30728.1/T)
- T 1 tubo in policarbonato / polycarbonate tube
30647

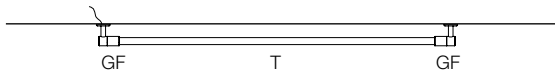

2 TUBI LED / 2 LED TUBES

- 1 gruppo d'alimentazione remoto
remote power supply
30721
- GF 2 giunti finali per T5 / terminal joints for T5
30728 + 30728.1
o
(30728/T + 30728.1/T)
- T 1 giunto intermedio per T5 / intermediate joint for T5
30729 (30729/T)
- E 2 tubi in policarbonato / polycarbonate tubes
30647

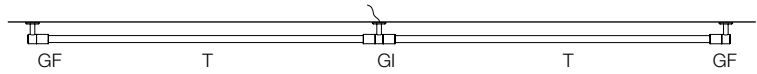

SHANGHAI FLUORESCENT

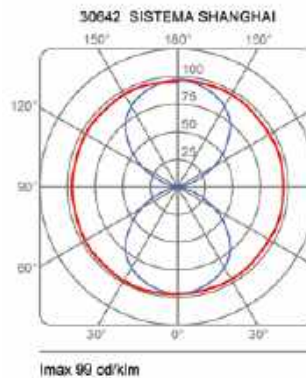

SHANGHAI LED

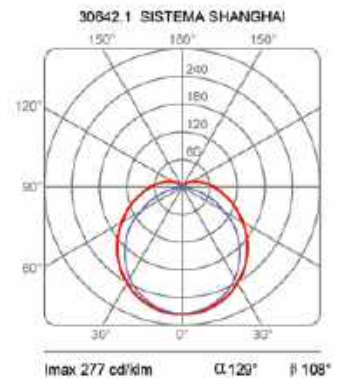

SHANGHAI

rosoni e accessori / ceiling rose and accessories

Rosoni in alluminio verniciato da fissare al soffitto completi di alimentatore per tubi fluorescenti o a LED.

Ceiling rose to fix on the ceiling with driver for fluorescent or LED tube.

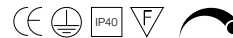

watt	CCT	Kg	colore/colour	codice/code
------	-----	----	---------------	-------------

ROSONI / CEILING ROSE

per 1 tubo fluorescente / for 1 fluorescent tube

1x49W 230V	dimmerabile/dimmable	1	○ bianco/white	30644/DIM/BI
1x49W 230V	non dimmerabile/non dimmable	1	○ bianco/white	30644/J/BI



per 2 tubi fluorescenti / for 2 fluorescent tubes

2x49W 230V	dimmerabile/dimmable	1,5	○ bianco/white	30645/DIM/BI
2x49W 230V	non dimmerabile/non dimmable	1,5	○ bianco/white	30645/J/BI



per tubi led / for led tube

Ø12 H3		0,5	○ bianco/white	30721/BI
--------	--	-----	----------------	----------

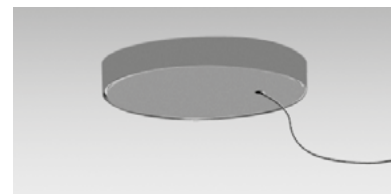

ACCESSORI / ACCESSORIES

schermo antiabbagliamento in alluminio / aluminium anti-glare screen

0,5	● grigio/grey	30650
-----	---------------	-------

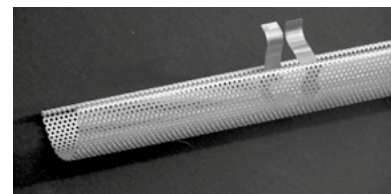

film radiant da inserire all'interno del tubo / radiant film to be placed inside the tube

0,5	● multicolor	30775
-----	--------------	-------

film diffondente per tubo LED / diffusing film for LED tube

0,5	○ bianco/white	30902
-----	----------------	-------

TUBO LED / LED TUBE

20W G5 T5 230V	3000K	5289.2
----------------	-------	--------



Mercato Centrale, Torino – Dolce e Luce Studio – arch. Barbora Nacarova

SHANGHAI

Lampada a sospensione formata da 4 moduli tubolari indipendenti a luce diffusa. Versioni con moduli per tubi fluorescenti o per tubi LED. Giunti trasparenti. È possibile regolare l'altezza e l'angolo di ogni modulo per creare diverse configurazioni. Rosone in alluminio verniciato bianco. Nella versione fluorescente il rosone è completo di alimentatori elettronici.

Suspension lamp with diffused light, made of 4 tubular modules. For fluorescent or LED tube module versions. Transparent joints. Possibility to adjust the height and angle of any module to create infinite configurations. White painted aluminum ceiling rose. In the fluorescent version, the ceiling rose is complete with driver.

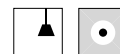

watt	flusso/flux	CCT	Kg	colore/colour	codice/code
------	-------------	-----	----	---------------	-------------

SHANGHAI LED					
4x20W G5 T5 230V	3000K		7	trasparente/transparent	2053/4/L/1

SHANGHAI FLUORESCENTE / FLUORESCENT					
4x49W FL G5 T5			7	trasparente/transparent	2053/4/DIM

rosone con alimentatore elettronico dimmerabile / ceiling rose with electronic dimmable driver

ACCESSORI / ACCESSORIES

schermo antiabbagliamento in alluminio / aluminium anti-glare screen

0,5	grigio/grey	30650
-----	-------------	-------

film radiant da inserire all'interno del tubo / radiant film to be placed inside the tube

0,5	multicolor	30775
-----	------------	-------

film diffondente per tubo LED / diffusing film for LED tube

0,5	bianco/white	30902
-----	--------------	-------

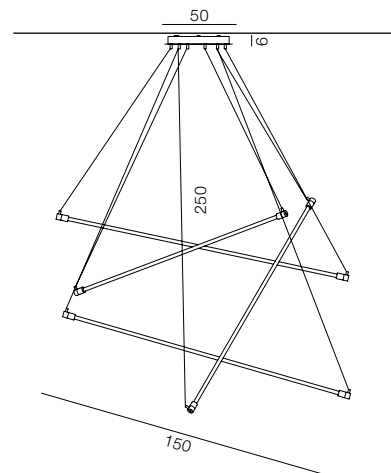

SHANGHAI FLUORESCENT

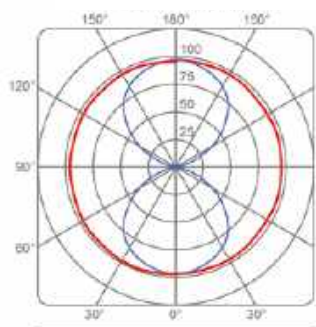

SHANGHAI LED

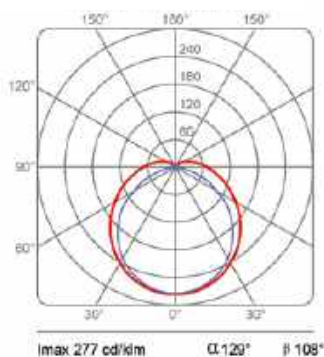

curve relative a un singolo tubo
single tube lighting curves







KOKO

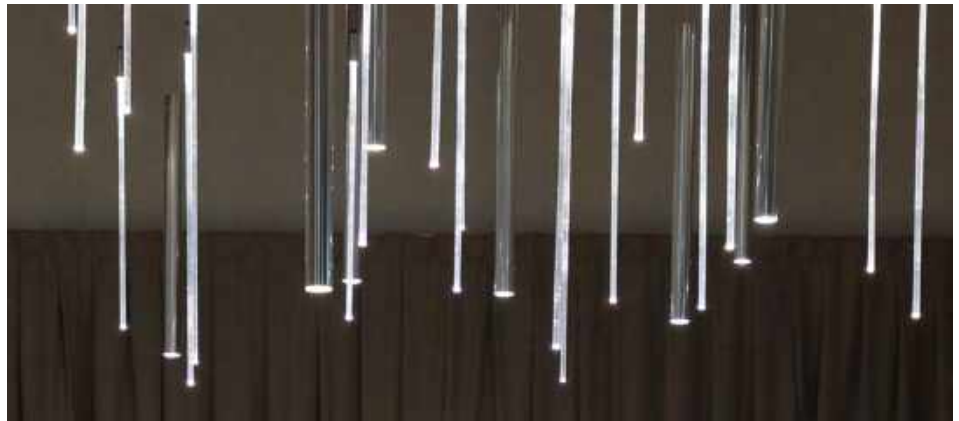

Una serie di elementi cilindrici di piccole dimensioni e di varie lunghezze, in alluminio e in metacrilato trasparente, scendono dal soffitto come canne d'organo disposti diversamente e creano un gioco di luci e di riflessi. Una soluzione illuminotecnica componibile sia per un impiego pubblico che residenziale. Le versioni singole a sospensione, da soffitto e a parete sono disponibili nel catalogo lampade.

A series of small-sized tubular elements in different lengths, in aluminium and transparent methacrylate, that come down from the ceiling like asymmetrically placed organ pipes to create a game of lights and reflections. A technical modular lighting solution ideal for public as well as residential environments. Single suspension, ceiling and wall versions are available in the lamp catalogue.







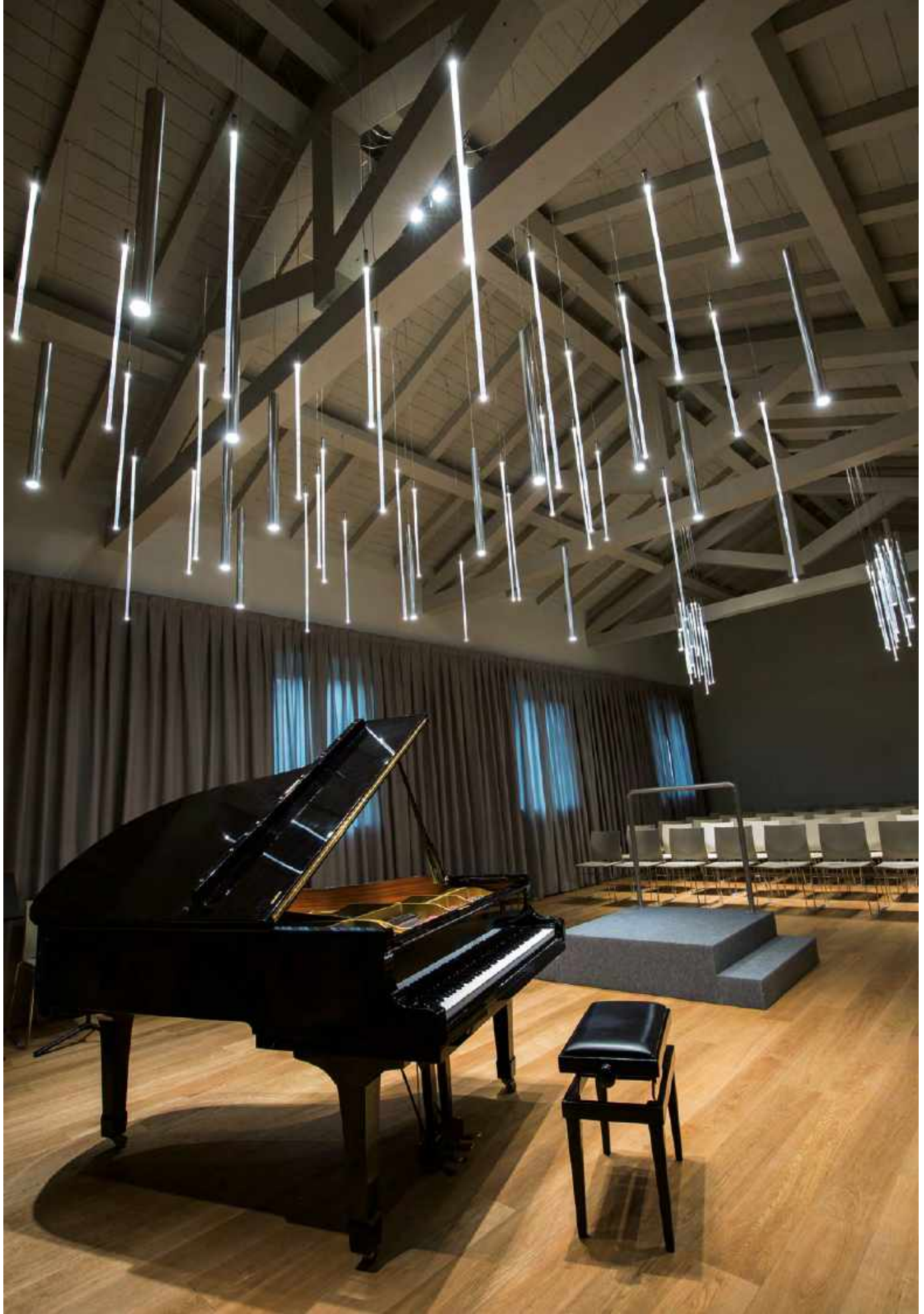

Liceo Musicale A. Passaglia – S. Agostino, Lucca – arch. Fabrizio Mechini, Francesca Lazzari





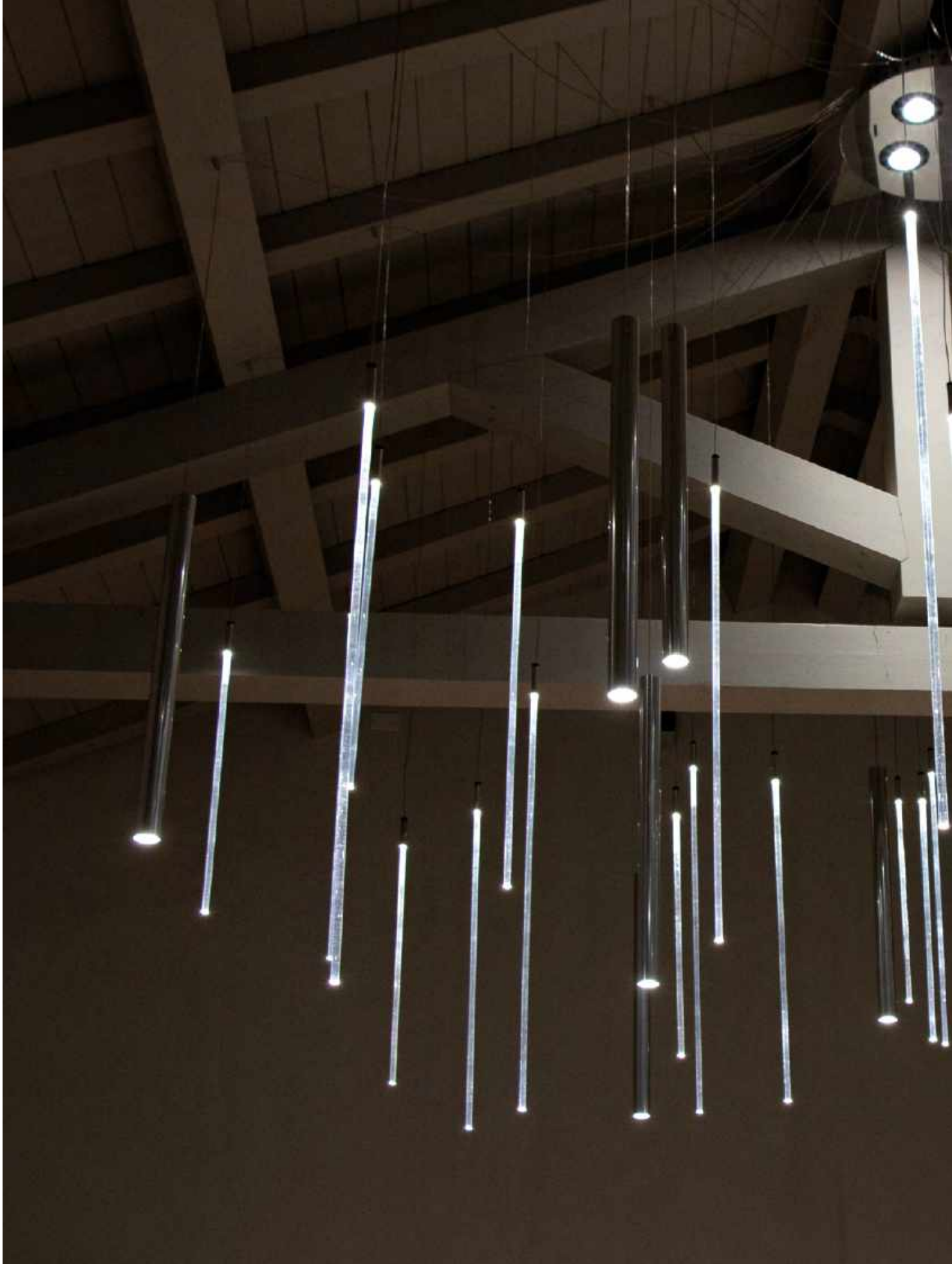



KOKO

componibile / modular

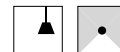

Lampada a sospensione a luce diretta, componibile secondo le esigenze del progetto con i profili in alluminio e metacrilato disponibili. Sorgente di luce a LED. Rosone in metallo lucido completo di alimentatori elettronici e sorgente luce a LED al centro, vedi esempio nella foto a lato e nella foto della pagina precedente anche per una disposizione a granchio.

Suspension lamp with direct light and modular, depending on the needs of the project, available with the aluminium and methacrylate profiles. LED light source. Polished metal ceiling rose complete with electronic drivers and LED light source in the center, see example in the picture on the side and the picture on the previous page for a crab arrangement.

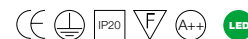

watt fascio/beam flusso/flux CCT Kg colore/colour codice/code

MODULI IN ALLUMINIO / ALUMINIUM MODULES

profilo in alluminio / aluminium profile H 50

1x9W 230V narrow 1120lm 3000K 1,3 ● lucido/polished 40140/LU

profilo in alluminio / aluminium profile H 80

1x9W 230V narrow 1120lm 3000K 1,5 ● lucido/polished 40141/LU

MODULI IN METACRILATO / METHACRYLATE MODULES

profilo in metacrilato / methacrylate profile H 80

1x3W 230V 300lm 3000K 1,3 ◯ trasparente/transparent 40138/MC/LU A+

profilo in metacrilato / methacrylate profile H 120

1x3W 230V 300lm 3000K 1,3 ◯ trasparente/transparent 40139/MC/LU A+

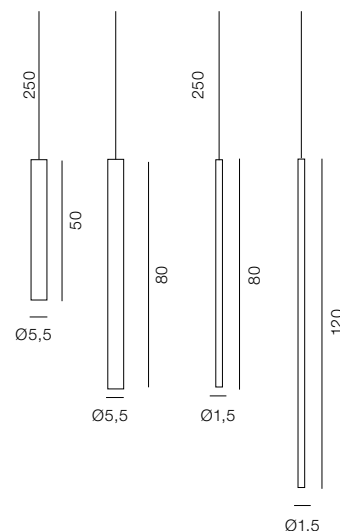

ROSONI con alimentatori integrati / CEILING ROSE with integrate drivers

rosone per 6 moduli / ceiling rose for 6 modules Ø40 H6 60W+9W 40142/LU

rosone per 15 moduli / ceiling rose for 15 modules Ø60 H6 150W+9W 40143/LU

rosone per 25 moduli / ceiling rose for 25 modules Ø80 H6 250W+9W 40144/LU

LED integrato nel rosone a soffitto / integrated LED in the ceiling rose 1x9W

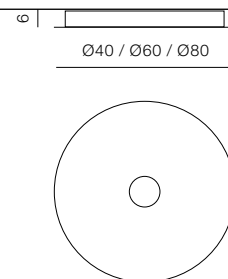

KOKO ALLUMINIO / ALUMINIUM

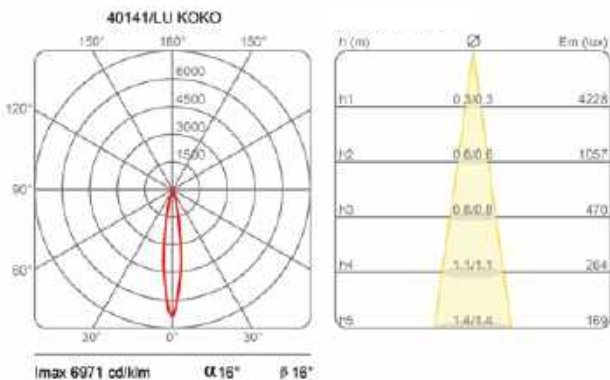

KOKO METACRILATO / METHACRYLATE

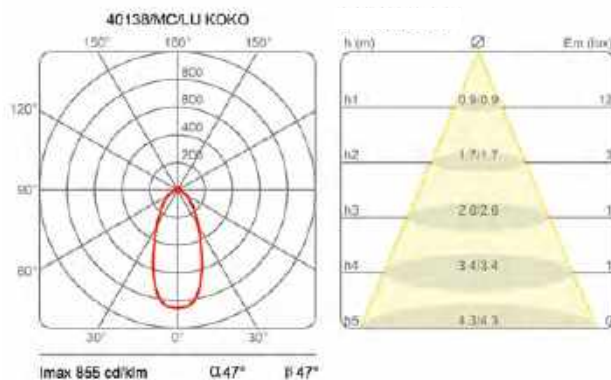





SISTEMA U

LIGHTYOU LIKE



Un semplice binario elettrificato da fissare al soffitto, a parete o sospeso, supporta degli spots orientabili e posizionabili su tutta la lunghezza del modulo. Disponibile anche nelle versioni a sospensione come faretto singolo e a parete con supporto. Sorgente di luce a LED con ottiche intercambiabili, dimmerabile con tecnologia bluetooth, per soddisfare le varie esigenze illuminotecniche sia in ambito espositivo che di lavoro.

A simple electrified track to be fixed to the ceiling, to the wall, or hanging, supports adjustable spotlights that can be positioned along the entire length of the module. Also available as single suspension spotlight and wall support versions. LED light source with interchangeable optics, dimmable with bluetooth technology, to satisfy various lighting needs both in exhibition and in workplace contexts.









Farmacia comunale 3, Camaione, Lucca – arch. Simone Bruni









SISTEMA U

spot per binario / spot for track



Il Sistema U è composto da faretti a luce diretta orientabile con un particolare snodo. Caratterizzati da un attacco che abbraccia e si collega al binario elettrificato 48V da sospendere, da fissare a soffitto o parete. Sorgente di luce a LED con ottiche a diversi fasci di luce.

Alimentatore remoto o nel rosone al soffitto, dimmerabile con dispositivo bluetooth con binario compatibile.

Systema U is composed of direct-light spotlights that can be oriented thanks to a special adjustable joint. It is characterized by a terminal that embraces and connected to the electrified track 48V to be suspended or fixed to the ceiling or wall.

LED light source with different light beams optics. Remote driver or in the ceiling rose, dimmable with bluetooth device with compatible track.



watt	fascio/beam	flusso/flux	CCT	Kg	colore/colour	codice/code
------	-------------	-------------	-----	----	---------------	-------------

FARETTO non dimmerabile / non dimmable SPOT

13W 48V	narrow	1950lm	3000K	0,5	○ bianco/white	1441/20/BI
	narrow				● nero/black	1441/20/NE
	wide				○ bianco/white	1441/38/BI
	wide				● nero/black	1441/38/NE

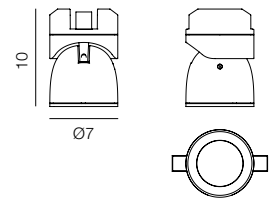

FARETTO dimmerabile / dimmable SPOT

13W 48V	narrow	1950lm	3000K	0,5	○ bianco/white	1441/20/DIM/BI
	narrow				● nero/black	1441/20/DIM/NE
	wide				○ bianco/white	1441/38/DIM/BI
	wide				● nero/black	1441/38/DIM/NE

BLUETOOTH

dispositivo Casambi bluetooth per la dimmerazione indipendente di ogni singolo faretto - in abbinamento ai faretti dimmerabili - (Casambi app. iOS e Android free) 545J 

bluetooth device for an independent dimming of each individual spotlight together with dimmable spotlights (Casambi app. iOS e Android free)

dispositivo bluetooth per la dimmerazione del binario elettrificato 48V 500X

da ordinare in abbinamento ai faretti (ON/OFF) non dimmerabili
bluetooth device to dimmer the 48V electrified track
to be ordered together with the non dimmable (ON/OFF) spotlights

per binario elettrificato a 48V, alimentatore remoto e rosone con alimentatore vedi pagine 356-357 dedicate ai binari.

for 48V electrified track, remote driver and ceiling rose with driver, see the pages 356-357 dedicated to the tracks.

ACCESSORIO ANTIABBAGLIAMENTO / ANTIGLARING ACCESSORY

honey comb ● nero/black 40087/NE

UGR<19

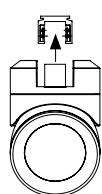

binario elettrificato
electrified track

spot

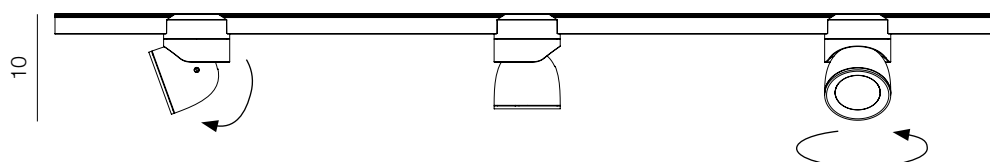

SISTEMA U - NARROW

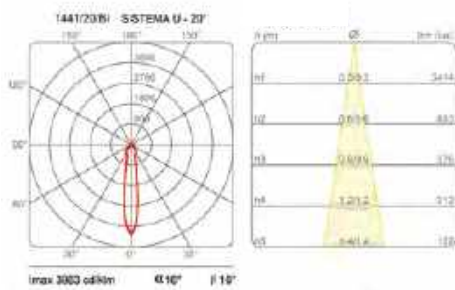

SISTEMA U - NARROW + HONEY COMB

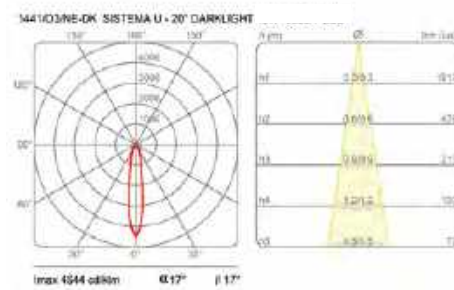

SISTEMA U - WIDE

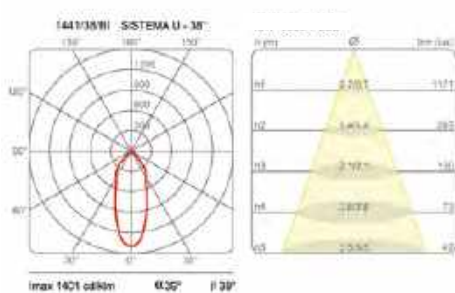

SISTEMA U - WIDE + HONEY COMB

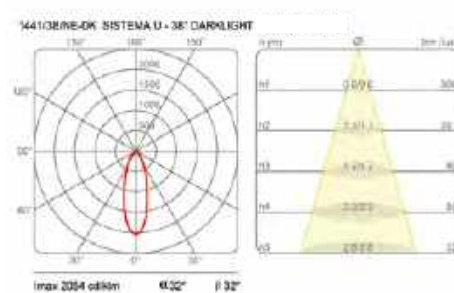

SISTEMA U

soffitto-parete / ceiling-wall



Faretto da parete a luce diretta, orientabile con un particolare snodo. Struttura in alluminio verniciato.
Sorgente di luce a LED con ottiche a diversi fasci di luce.
Alimentatore integrato nel corpo lampada o remoto.

Direct-light spotlight that can be oriented thanks to a special adjustable joint. Painted aluminium structure.
LED light source with different light beams optics. Integrated driver or remote.

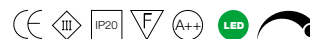

watt	fascio/beam	flusso/flux	CCT	Kg	colore/colour	codice/code
FARETTO SPOT L17						
13W 230V	narrow	1950lm	3000K	0,5	○ bianco/white	1452/20/BI
	narrow				● nero/black	1452/20/NE
	wide				○ bianco/white	1452/38/BI
	wide				● nero/black	1452/38/NE

alimentatore integrato nel corpo lampada / power supply integrated in the body lamp
230/350mA
non dimmerabile / non dimmable

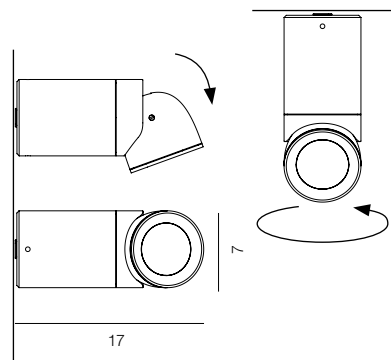

FARETTO SPOT L10						
13W 350mA	narrow	1950lm	3000K	0,5	○ bianco/white	1452/J/20/BI
	narrow				● nero/black	1452/J/20/NE
	wide				○ bianco/white	1452/J/38/BI
	wide				● nero/black	1452/J/38/NE

alimentatore remoto / remote driver

40W 230V/350mA (max 3 spots) 0,6 40164

40W 230V/350mA (max 3 spots) 1 40165

dimmerabile / dimmable

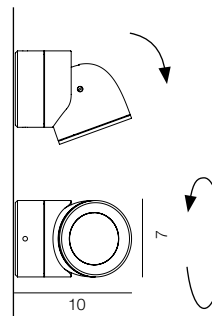

ACCESSORIO ANTIABBAGLIAMENTO / ANTIGLARING ACCESSORY

honey comb ● nero/black 40087/NE
UGR<19

per diagrammi illuminotecnici vedi pagina precedente 291.
for lighting curve see the previous page 291.





SISTEMA U

sospensione singola con rosone / single suspension with ceiling rose



Faretto a sospensione a luce diretta, orientabile.
Struttura in alluminio verniciato.
Sorgente di luce a LED con ottiche a diversi fasci di luce.
Con cavo di sospensione e rosone per sospensione singola.

Suspension lamp with direct light, adjustable.
Painted aluminum structure.
LED light source with optics in different light beams.
With suspension cable and ceiling rose for single suspension.

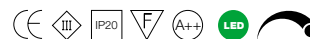

watt	fascio/beam	flusso/flux	CCT	Kg	colore/colour	codice/code
FARETTO con alimentatore remoto / SPOT with remote driver						
13W 350mA	narrow	1950lm	3000K	0,5	○ bianco/white	21014/20/BI
	narrow				● nero/black	21014/20/NE
	wide				○ bianco/white	21014/38/BI
	wide				● nero/black	21014/38/NE
alimentatore remoto / remote driver						
40W 230V/350mA	(max 3 spots)			0,6		40164
40W 230V/350mA	(max 3 spots)			1		40165
dimmerabile / dimmable						

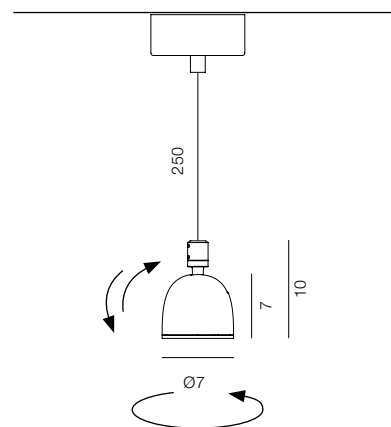

FARETTO con alimentatore integrato / SPOT with integrated driver						
13W 230V	narrow	1950lm	3000K	0,5	○ bianco/white	21013/20/BI
	narrow				● nero/black	21013/20/NE
	wide				○ bianco/white	21013/38/BI
	wide				● nero/black	21013/38/NE

rosone / ceiling rose Ø9 H4

alimentatore integrato nel rosone 230/350mA / integrated driver in the ceiling rose 230/350mA.

ACCESSORIO ANTIABBAGLIAMENTO / ANTIGLARING ACCESSORY

honey comb	● nero/black	40087/NE
UGR<19		

per diagrammi illuminotecnici vedi pagina precedente 291.
for lighting curve see the previous page 291.







Una luce d'accento che discretamente scompare.
Il sistema è composto da una canalina al cui interno, un binario elettrificato supporta dei faretti orientabili con un particolare braccio articolato.
I corpi illuminanti all'interno della canalina si spostano ed estratti sono orientabili a 360°.
Disponibile nelle versioni da fissare a soffitto, da incasso e a sospensione.
Con ottiche a diversi fasci di luce, dimmerabile con tecnologia bluetooth.

Accent lighting that discreetly disappears.
The system consists of a channel inside which an electrified track supports adjustable spotlights with a particular articulated arm.
The spotlights contained in the channel can be moved and extracted, they are adjustable at 360°.
Available to be fixed to the ceiling, recessed and suspended.
With different light beams optics, dimmable with bluetooth technology.













RICCIO

canalina con faretti / channel with spots

Il sistema Riccio è composto da una canalina in alluminio verniciato con un binario elettrificato fissato al suo interno, che permette, tramite adattatore, il fissaggio e lo spostamento dei faretti a LED orientabili.

Un braccetto con doppio snodo degli spot permette, quando è estratto dalla canalina, la piena orientabilità in tutte le direzioni.

Riccio è sospeso con cavi in acciaio o con supporti per il fissaggio al soffitto e nella versione da incasso. Disponibile con ottiche a diversi fasci di luce.

Riccio system is composed of a painted aluminium channel with an electrified track fixed on the inside, which allows, through a particular attachment, the fixing and movement of the adjustable LED spotlights.

The spotlight can be turned and tilted in any direction when the double joint arm of the spot is removed from the channel. Riccio is suspended with steel cables, with ceiling mounting supports, or in recessed version. Available with different light beams optics.

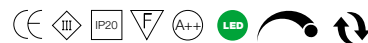

watt	fascio/beam	flusso/flux	CCT	Kg	colore/colour	codice/code
------	-------------	-------------	-----	----	---------------	-------------

FARETTO non dimmerabile / non dimmable SPOT

9W 48V	narrow	1120lm	3000K	1	○ bianco/white	1447/14/BI
9W 48V	narrow	1120lm	3000K	1	● nero/black	1447/14/NE
9W 48V	wide	1120lm	3000K	1	○ bianco/white	1447/32/BI
9W 48V	wide	1120lm	3000K	1	● nero/black	1447/32/NE

FARETTO dimmerabile / dimmable SPOT 

9W 48V	narrow	1120lm	3000K	1	○ bianco/white	1447/14/DIM/BI
9W 48V	narrow	1120lm	3000K	1	● nero/black	1447/14/DIM/NE
9W 48V	wide	1120lm	3000K	1	○ bianco/white	1447/32/DIM/BI
9W 48V	wide	1120lm	3000K	1	● nero/black	1447/32/DIM/NE

CANALINA per sospensione o per plafone / suspension or ceiling CHANNEL 100-200 cm

230/48V L100				4	○ bianco/white	40098/BI
					● nero/black	40098/NE
230/48V L200				4	○ bianco/white	40146/BI
					● nero/black	40146/NE

cavi di sospensione / hanging cable 3 m

CANALINA da incasso / recessed CHANNEL 100 cm

230/48V L100				4	○ bianco/white	40145/BI
					● nero/black	40145/NE

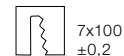
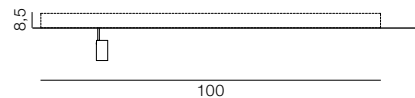
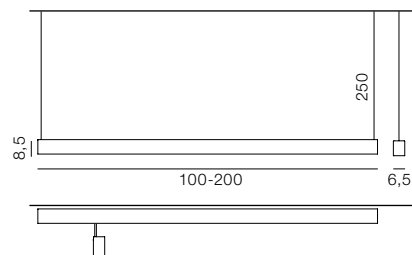
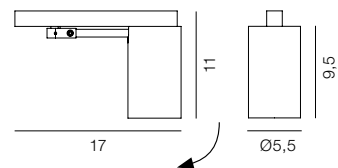

GIUNTI / JOINTS

giunto intermedio / intermediate joint	○ bianco/white	40103/BI
	● nero/black	40103/NE
testata di chiusura / terminal head	○ bianco/white	40131/BI
	● nero/black	40131/NE
connettore elettrico / electric connector	○ bianco/white	524.1J
	● nero/black	524J
testata di alimentazione / feeding head	○ bianco/white	523.1J
	● nero/black	523J



CANALINA PER SOSPENSIONE / SUSPENSION CHANNEL

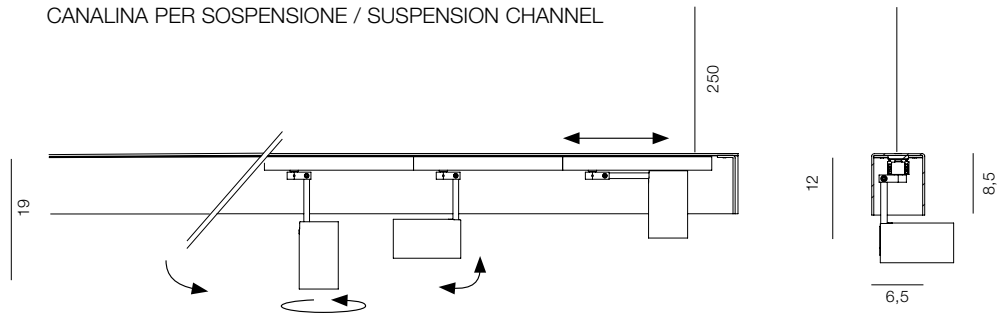

CANALINA DA INCASSO / RECESSED CHANNEL

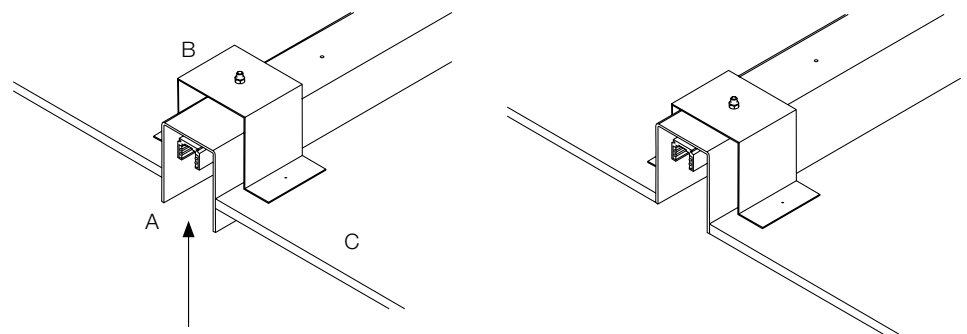
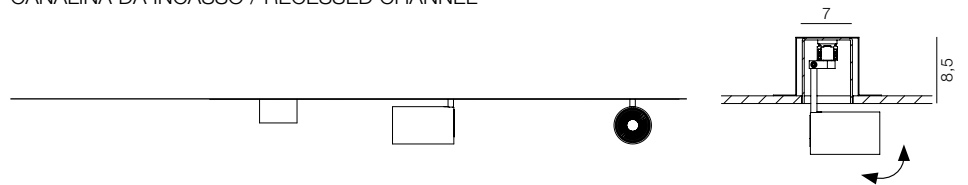

A) canalina / channel

B) supporto di fissaggio / fixing support

C) cartongesso / plasterboard

RICCIO

alimentatori / drivers



Alimentatori per il collegamento del sistema Riccio alla rete da posizionare in remoto o inseriti all'interno del rosone da fissare al soffitto. Dispositivo bluetooth per la dimmerazione da fissare al binario.

Drivers for connecting the Riccio system to the power grid to be positioned remotely or inserted inside the ceiling rose. Bluetooth device for dimming to be fixed to electrified track.



watt	dimension	Kg	colore/colour	codice/code
ALIMENTATORE REMOTO / REMOTE DRIVER				
60W 230/48V (max 5 spots)		0,6		5142.3
100W 230/48V (max 9 spots)		0,6		5142.1
200W 230/48V (max 18 spots)		1		5142.2
ROSONE CON ALIMENTATORE / CEILING ROSE WITH DRIVER				
100W 230/48V (max 9 spots)	35x8 H5 cm	1,5	○ bianco/white	40086/BI
100W 230/48V (max 9 spots)		1,5	● nero/black	40086/NE
200W 230/48V (max 18 spots)	35x8 H5 cm	1,9	○ bianco/white	40086.1/BI
200W 230/48V (max 18 spots)		1,9	● nero/black	40086.1/NE

BLUETOOTH

dispositivo Casambi bluetooth per la dimmerazione indipendente di ogni singolo faretto - in abbinamento ai faretti dimmerabili - (Casambi app. iOS e Android free) 545J 
 bluetooth device for an independent dimming of each individual spotlight together with dimmable spotlights (Casambi app. iOS e Android free)

dispositivo bluetooth per la dimmerazione del binario elettrificato 48V da ordinare in abbinamento ai faretti non dimmerabili 500X
 bluetooth device to dimmer the 48V electrified track to be ordered together with the non dimmable spotlights

RICCIO - NARROW

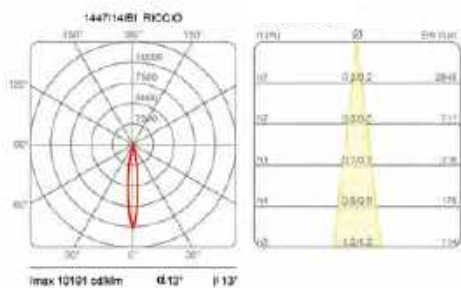

RICCIO - WIDE

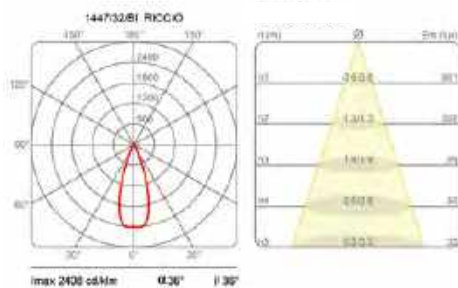



RICCIO

incasso / built-in

Il sistema Riccio comprende anche un faretto orientabile ad incasso a scomparsa tramite un supporto telescopico fissato alla struttura in alluminio verniciato.
Sorgente di luce a LED con diverse aperture del fascio luminoso.
Alimentatore remoto nel controsoffitto.

The Riccio system also includes a recessed and adjustable spotlight that can be oriented by means of a telescopic support fixed to painted aluminium structure.
LED light source with different light beam angles.
Remote driver in the false ceiling.

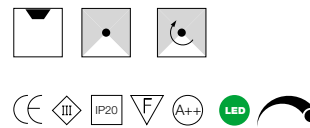

watt	fascio/beam	flusso/flux	CCT	Kg	colore/colour	codice/code
FARETTO / SPOT						
9W 500mA	narrow	1120lm	3000K	1	○ bianco/white	1451/14/BI
	narrow	1120lm	3000K	1	● nero/black	1451/14/NE
	wide	1120lm	3000K	1	○ bianco/white	1451/32/BI
	wide	1120lm	3000K	1	● nero/black	1451/32/NE

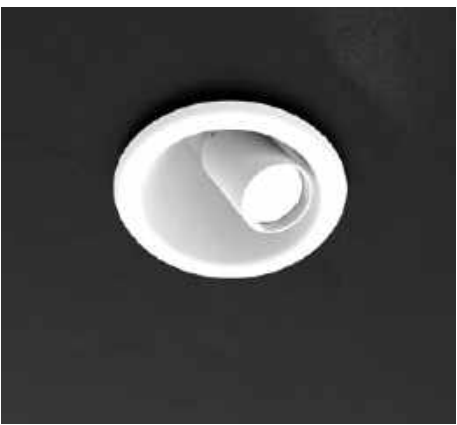
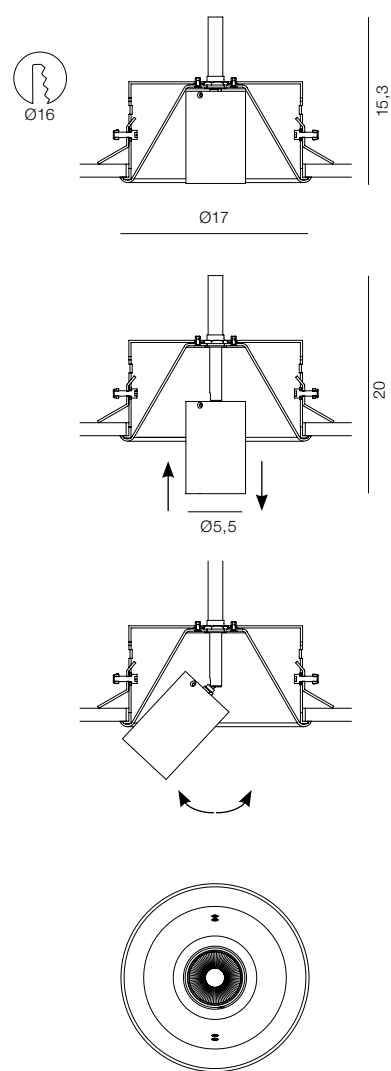

ALIMENTATORE REMOTO/REMOTE DRIVER

30W 230V (max 3 spots) non dimmerabile / non dimmable	0,6	506X
30W 230V (max 3 spots) dimmerabile / dimmable 	0,6	507X

BLUETOOTH 		
dispositivo bluetooth per la dimmerazione bluetooth dimming device		500X





BOMBO – CIP

LIGHTYOU LIKE



Una serie di faretto orientabili per una luce d'accento con attacco per binario elettrificato a 48V, sospeso, fissato a soffitto e da incasso. Per sorgente di luce a LED con ottiche diverse e dark light. Dimmerabile con tecnologia bluetooth. Adatti per l'illuminazione in diversi ambiti, residenziale, espositivo e di lavoro.

A series of adjustable spotlights for an accent light with a 48V electrified track attachment, available in different versions: suspended, fixed to the ceiling and recessed. For LED light source with different optics and dark light. Dimmable with bluetooth technology. Suitable for lighting in various areas: work, residential, exhibitions.

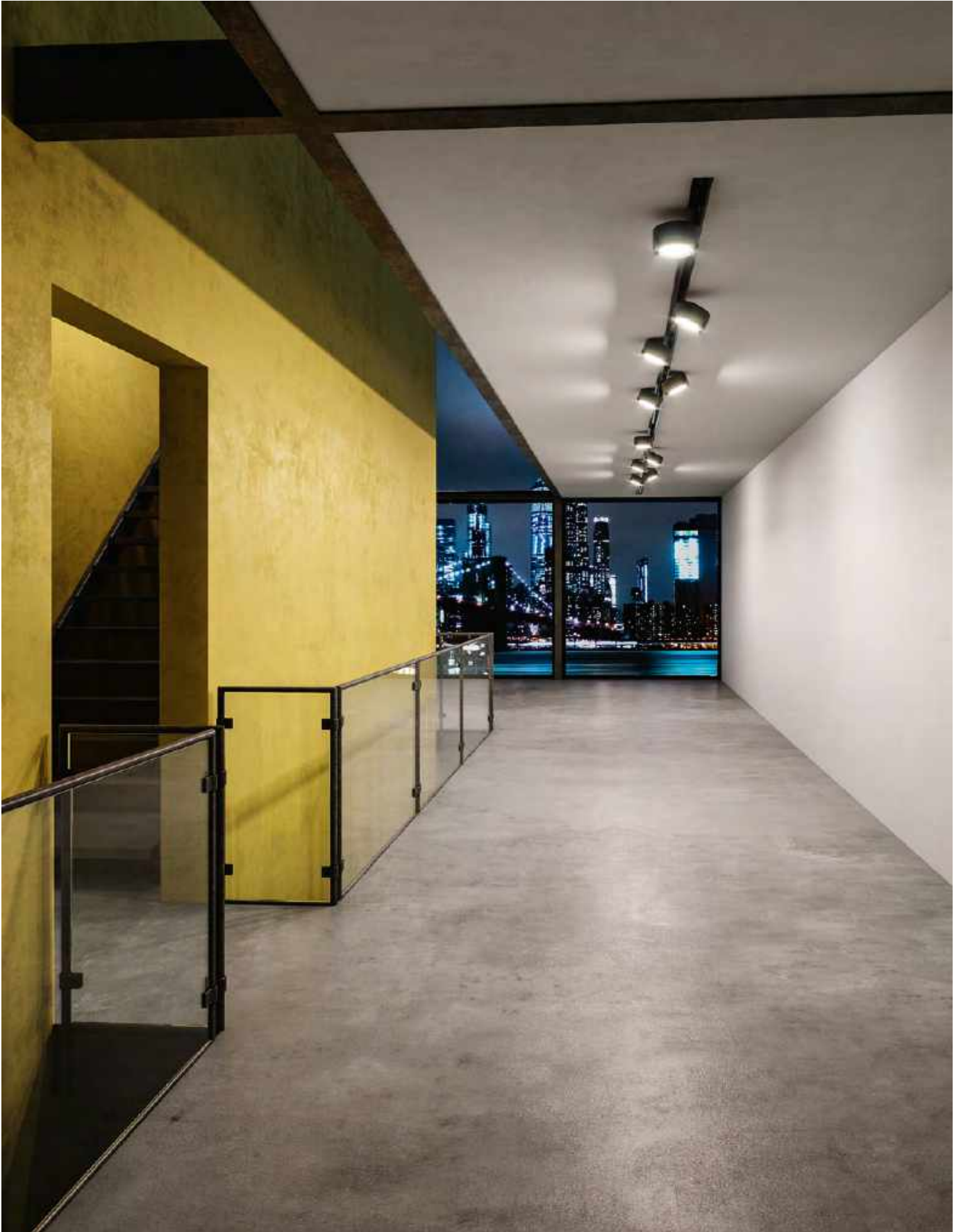

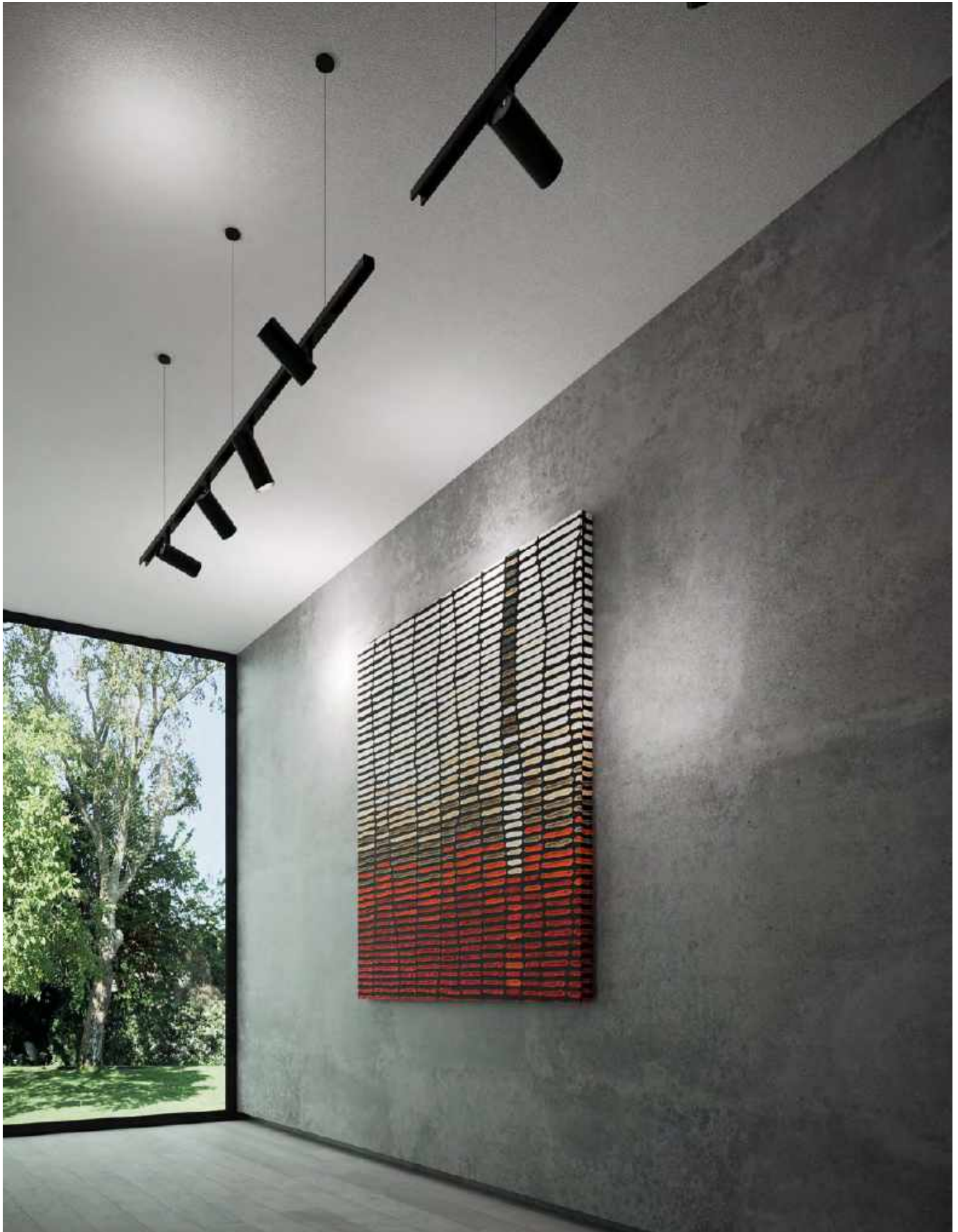

BOMBO – CIP

Faretti orientabili per sorgente di luce LED con varie aperture del fascio luminoso, con adattatore per binario elettrificato 48V, a sospensione, da fissare al soffitto o da incasso. Struttura in alluminio verniciato. Alimentatore remoto o nel rosone al soffitto, dimmerabile con dispositivo bluetooth con binario compatibile. Bombo con schermo antiabbagliamento UGR<19.

Swivel Spot for LED light source with various light beam angles and a 48V electrified track attachment, suspended, to fix on the ceiling or recessed versions. Painted aluminium structure. Remote driver or in the ceiling rose, dimmable with bluetooth device with compatible track. Bombo with anti-glare screen UGR <19.

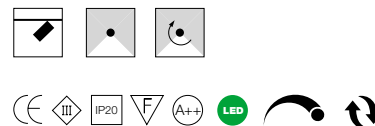

watt	fascio/beam	flusso/flux	CCT	Kg	colore/colour	codice/code
------	-------------	-------------	-----	----	---------------	-------------

BOMBO non dimmerabile / not dimmable UGR<19



17,3W 48V	narrow	2145lm	3000K	1	○ bianco/white	1448/14/BI
	narrow				● nero/black	1448/14/NE
	wide				○ bianco/white	1448/35/BI
	wide				● nero/black	1448/35/NE

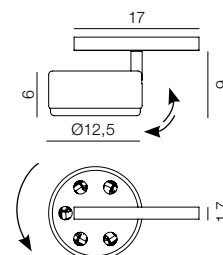

BOMBO dimmerabile / dimmable UGR<19

17,3W 48V	narrow	2145lm	3000K	1	○ bianco/white	1448/14/DIM/BI
	narrow				● nero/black	1448/14/DIM/NE
	wide				○ bianco/white	1448/35/DIM/BI
	wide				● nero/black	1448/35/DIM/NE

BOMBO parete-soffitto non dimmerabile / wall-ceiling not dimmable UGR<19



17,3W 230V	narrow	2145lm	3000K	1	○ bianco/white	1456/14/BI
	narrow				● nero/black	1456/14/NE
	wide				○ bianco/white	1456/35/BI
	wide				● nero/black	1456/35/NE

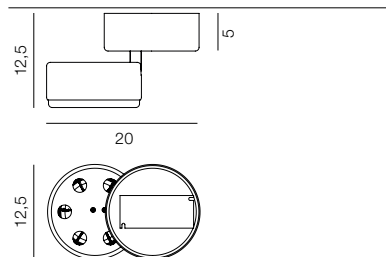

CIP non dimmerabile / non dimmable

9W 48V	narrow	1120lm	3000K	1	○ bianco/white	1449/14/BI
	narrow				● nero/black	1449/14/NE
	wide				○ bianco/white	1449/32/BI
	wide				● nero/black	1449/32/NE

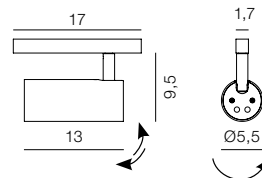

CIP dimmerabile / dimmable

9W 48V	narrow	1120lm	3000K	1	○ bianco/white	1449/14/DIM/BI
	narrow				● nero/black	1449/14/DIM/NE
	wide				○ bianco/white	1449/32/DIM/BI
	wide				● nero/black	1449/32/DIM/NE

per il binario elettrificato a 48V e alimentatore vedi pagine 356-357 dedicate ai binari.
for the 48V electrified track see the pages 356-357 dedicated to the tracks.



BOMBO soffitto / ceiling



BOMBO binario / track



CIP binario / track

BINARIO A SOSPENSIONE / SUSPENSION TRACK

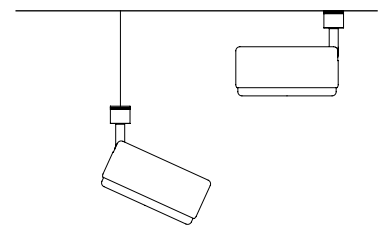
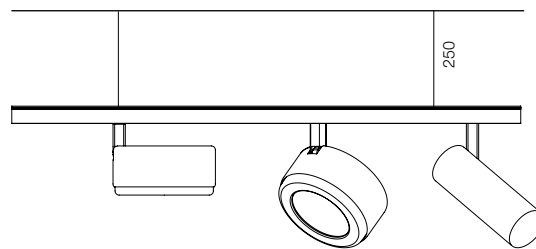

BINARIO DA INCASSO / RECESSED TRACK

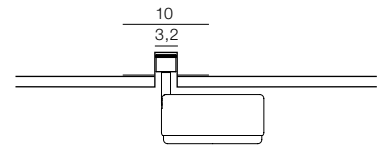
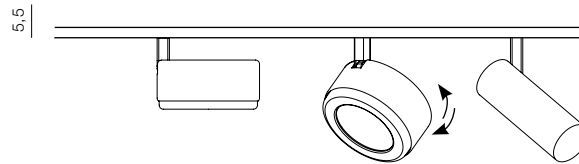

BLUETOOTH  

dispositivo Casambi bluetooth per la dimmerazione indipendente di ogni singolo faretto - in abbinamento ai faretto dimmerabili - (Casambi app. iOS e Android free)

bluetooth device for an independent dimming of each individual spotlight together with dimmable spotlights (Casambi app. iOS e Android free)

545J 

BOMBO - NARROW

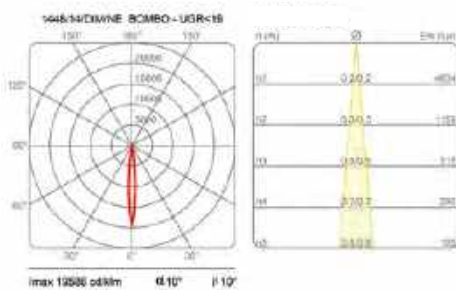

BOMBO - WIDE

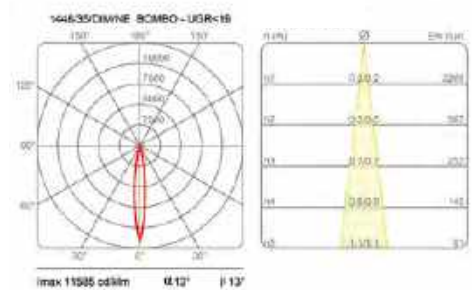

CIP - NARROW

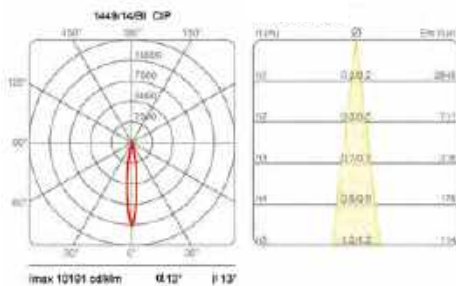

CIP - WIDE

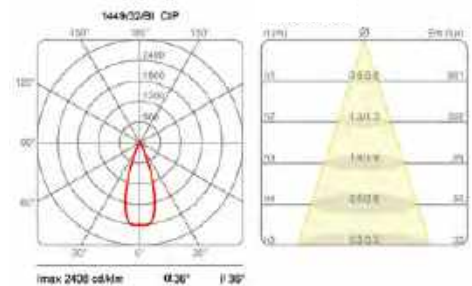

dispositivo bluetooth per la dimmerazione del binario elettrificato 48V da ordinare in abbinamento ai faretto (ON/OFF) non dimmerabili

bluetooth device to dimmer the 48V electrified track to be ordered together with the non dimmable (ON/OFF) spotlights

500X



GRILLO



Un piccolissimo punto di luce orientabile e direzionabile sul suo supporto di fissaggio, con sorgente di luce a LED, utile per creare effetti di luce e per valorizzare particolari.

An adjustable and directional tiny light point on its fixing support, with LED light source, useful to create lighting effects and to enhance details.









GRILLO

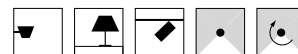

Una piccola luce orientabile e direzionabile adatta per esposizioni museali o commerciali per illuminazione di teche. Struttura in alluminio anodizzato nel colore nero.

Sorgente di luce a LED integrata con varie aperture del fascio luminoso. Alimentatore elettronico remoto (escluso).

Disponibile nelle versioni: con supporto per il fissaggio su un piano o una mensola; o con attacco per binario elettrificato a 48V. Per il binario elettrificato a 48V, alimentatore remoto e rosone con alimentatore vedi pagine 356-357 dedicate ai binari.

A small adjustable and directional light suitable for museum or commercial exhibitions and for lighting cases.

Black anodized aluminium structure. Integrated LED light source with various light beam angles. Remote electronic driver (excluded).

Available in the following versions: with support to be fixed on a surface or a shelf; or with 48V electrified track connection.

For the 48V electrified track, remote driver and ceiling rose with driver, see the pages 356-357 dedicated to the tracks.

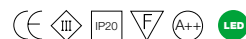

watt	fascio/beam	flusso/flux	CCT	Kg	colore/colour	codice/code
------	-------------	-------------	-----	----	---------------	-------------

GRILLO con supporto / GRILLO with support

4W 24V	medium	515lm	3000K	0,4	● nero/black	1438/NE
--------	--------	-------	-------	-----	--------------	---------

su richiesta con fascio stretto / on request with a narrow beam

alimentatore elettronico remoto / remote electronic driver (max 3 spots)

20W 230/24V						505X
-------------	--	--	--	--	--	------

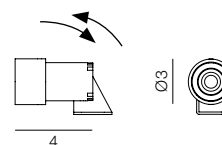

è possibile modificare il supporto di fissaggio del Grillo per adattarsi alle varie esigenze espositive (su richiesta).

it is possible to modify the Grillo fixing support in order to respond to the different exhibition needs (on request).

GRILLO con adattatori per binario 48V / GRILLO with track adapters 48V

adattatore con 1 spot / adapter with 1 spot

4W 24V	medium	515lm	3000K	0,4	● nero/black	1450/24/NE
--------	--------	-------	-------	-----	--------------	------------

adattatore con 2 spot / adapter with 2 spots

2x4W 24V	medium	2x515lm	3000K	0,7	● nero/black	1450/2/24/NE
----------	--------	---------	-------	-----	--------------	--------------

alimentatore elettronico remoto / remote electronic driver (max 4 spots)

25W

30811.1

su richiesta con fascio stretto / on request with a narrow beam

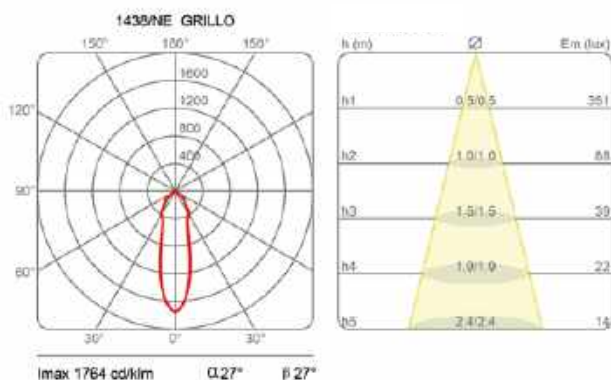
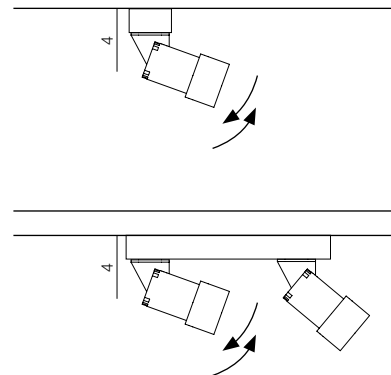





R19 / R11 / R14 / S20



Una serie di apparecchi orientabili da interno per una luce d'accento per binari elettrificati a 230V. Sorgente di luce a LED ad alto rendimento luminoso. Le varie aperture del fascio luminoso permettono di soddisfare le esigenze illuminotecniche di esercizi commerciali, musei ed uffici.

A series of adjustable devices for an accent lighting for 230V electrified track. Source of LED light with a high lighting performance. The different light beams angles satisfy the lighting needs of shopping centers, museums and offices.



**“Entrate,
ma non cercate
un percorso.
L'unica via è lo
smarrimento”**



Spazio Espositivo
di "L'Arte Povera"
L'Arte Povera 1965-1975
1965





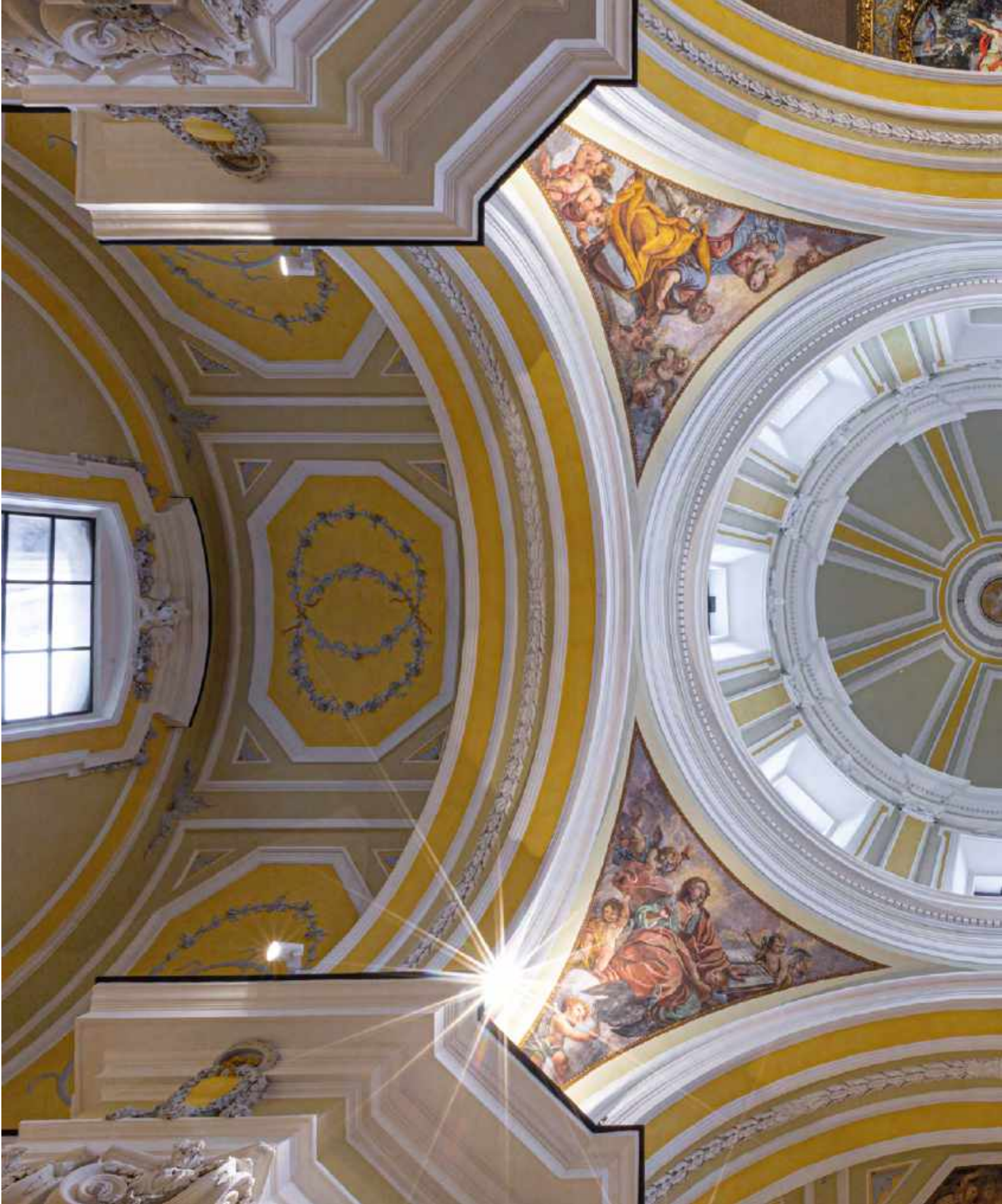

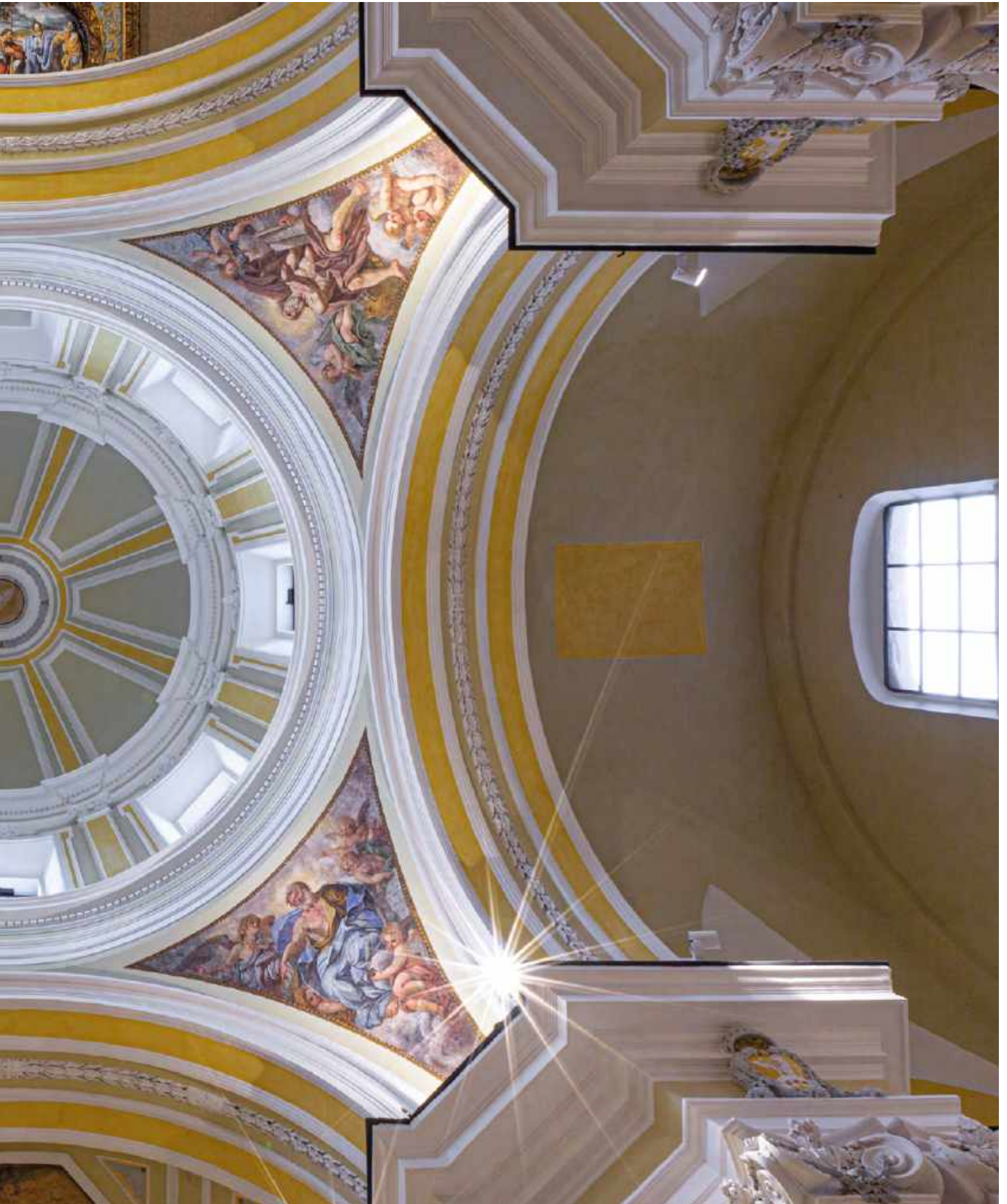







R19



Faretto a luce diretta orientabile con attacco per binario elettrificato a 230V.
 Un sistema regolabile con lente bifocale, permette di controllare l'angolo di apertura del fascio di luce da narrow a wide mantenendo un'alta efficienza luminosa.
 Struttura in alluminio verniciato.
 Sorgente di luce a LED.
 Vedi binari elettrificati nella pagina dedicata 354-355.

Direct light adjustable LED projector, for 230V electrified track.
 Swiveling system with double bifocal lenses, wich allows the light beams angles to be controlled from narrow to wide while maintaining high levels of efficiency.
 Painted aluminium structure.
 For LED light source.
 See electrified tracks related pages 354-355.







 CRI>95

watt	fascio/beam	flusso/flux	CCT	Kg	colore/colour	codice/code
------	-------------	-------------	-----	----	---------------	-------------

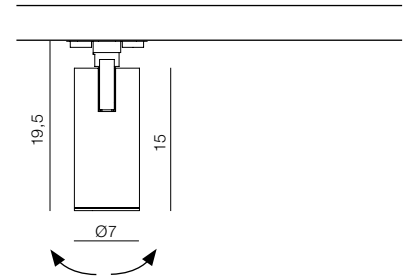
20W 230V	narrow-wide	2430lm	3000K		○ bianco/white	2887/BI
					● nero/black	2887/NE

angolo del fascio regolabile da narrow a wide / adjustable beam angle from narrow to wide

alimentatore integrato nel corpo lampada / integrated driver included into the body lamp.



su richiesta / on request 10W e 30W





R11

Apparecchio a luce diretta orientabile con attacco per binario elettrificato a 230V. Struttura in alluminio verniciato. Sorgente di luce a LED con diversi fasci luminosi. Alimentatore elettronico integrato nella base di attacco dell'apparecchio. Vedi binari elettrificati nella pagina dedicata 354-355.

Direct light adjustable LED projector for 230V electrified track. Painted aluminium structure. For LED light source with different beam angles. Electronic driver included inside the device. See electrified tracks related pages 354-355.



watt	fascio/beam	flusso/flux	CCT	Kg	colore/colour	codice/code
34W 230V	narrow	4800lm	3000K	2	○ bianco/white	1407/XL/16D/BI
					● antracite/anthracite	1407/XL/16D/AN
	medium				○ bianco/white	1407/XL/26D/BI
					● antracite/anthracite	1407/XL/26D/AN
	wide				○ bianco/white	1407/XL/36D/BI
					● antracite/anthracite	1407/XL/36D/AN

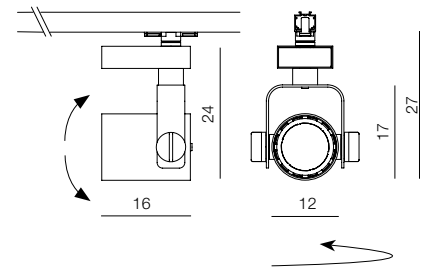



R11

Apparecchio a luce diretta orientabile con supporto da parete.
 Sorgente di luce a LED con diversi fasci luminosi.
 Struttura in alluminio verniciato.
 Alimentatore elettronico integrato nella base.

Direct light adjustable LED projector, with wall mounting support.
 LED light source with different light beams.
 Structure in painted aluminium.
 Integrated electronic driver into the base.

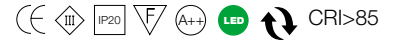

watt	fascio/beam	flusso/flux	CCT	Kg	colore/colour	codice/code
34W 230V	narrow	4800lm	3000K	2	○ bianco/white	1407/P/XL/16D/BI
					● antracite/anthracite	1407/P/XL/16D/AN
	medium				○ bianco/white	1407/P/XL/26D/BI
					● antracite/anthracite	1407/P/XL/26D/AN
	wide				○ bianco/white	1407/P/XL/36D/BI
					● antracite/anthracite	1407/P/XL/36D/AN

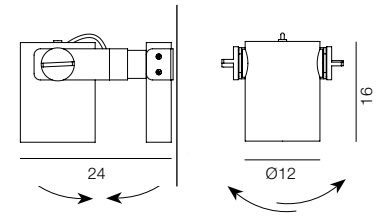



R11

Apparecchio a luce diretta orientabile con supporto e base per il fissaggio sopra a un cornicione o su altre superfici piane.
 Sorgente di luce a LED con diversi fasci luminosi.
 Struttura in alluminio verniciato.
 Alimentatore elettronico integrato nella base.

Direct light adjustable LED projector, with support and base for fixing over a cornice or flat surfaces.
 LED light source with different light beams.
 Structure in painted aluminium.
 Integrated electronic driver into the base.

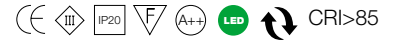

watt	fascio/beam	flusso/flux	CCT	Kg	colore/colour	codice/code	
34W 230V	narrow	4800lm	3000K	2	○ bianco/white	1407/C/XL/16D/BI	
					● antracite/anthracite	1407/C/XL/16D/AN	
	medium					○ bianco/white	1407/C/XL/26D/BI
						● antracite/anthracite	1407/C/XL/26D/AN
	wide					○ bianco/white	1407/C/XL/36D/BI
						● antracite/anthracite	1407/C/XL/36D/AN

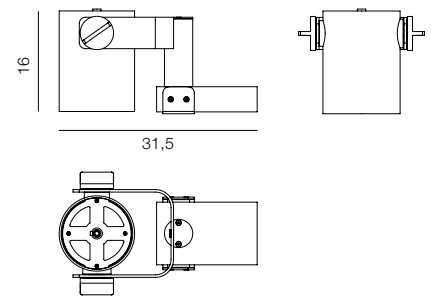

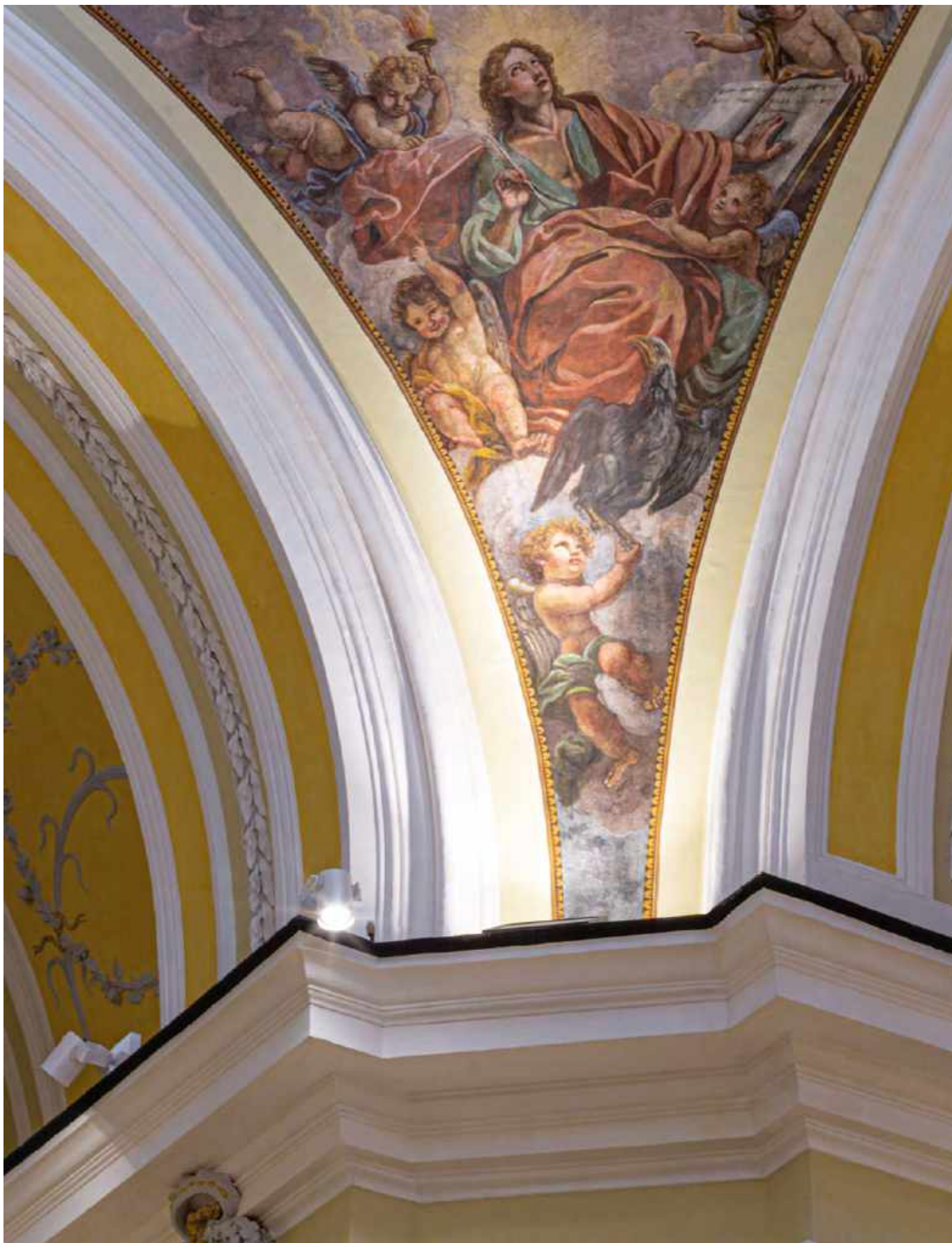

Chiesa di S. Giovanni Battista, Vietri sul mare, Salerno

R14

Apparecchio a luce diretta orientabile con adattatore per binario elettrificato a 230V. Struttura in alluminio verniciato. Alimentatore elettronico dimmerabile integrato nel corpo lampada. Sorgente di luce a LED, le diverse aperture del fascio luminoso permettono di soddisfare molte esigenze illuminotecniche. Vedi binari elettrificati nella pagine 354-355 dedicate.

Direct light adjustable LED projector with adapter for 230V electrified track. Painted aluminium structure. Electronic driver integrated inside the body lamp. LED light source, the different beam angles enable us to meet a large number of lighting needs. See electrified tracks related pages 354-355.

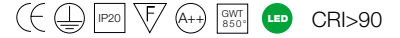

watt	fascio/beam	flusso/flux	CCT	Kg	colore/colour	codice/code
32W 230V	narrow	3840lm	3000K	2	● antracite/anthracite	1422/O/AN
	medium				● antracite/anthracite	1422/Q/AN
	wide				● antracite/anthracite	1422/R1/AN

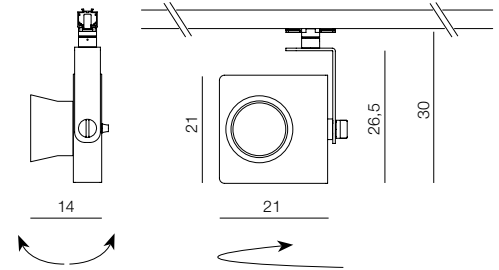



S20

Sagomatori di luce a luce diretta orientabile. Gruppo lenti in polimetilmetacrilato per offrire un controllo preciso del fascio di luce. Struttura in alluminio verniciato. Ideale per applicazioni museali e retail. Vedi binari elettrificati nella pagine dedicate 354-355 e 356-357.

Direct adjustable light profiles. Polymethylmethacrylate lens group to offer precise control of the light beam. Painted aluminium structure. Ideal for museums and retail applications. See electrified tracks related pages 354-355 and 356-357.



watt	fascio/beam	flusso/flux	CCT	Kg	colore/colour	codice/code
------	-------------	-------------	-----	----	---------------	-------------

S20 per binario 230V / S20 for 230V track

15W 230V	wide	1826lm	3000K	1,5	○ bianco/white	2898/BI
					● nero/black	2898/NE

CRI>97

S20J per binario 48V / S20J for 48V track

6W 500mA	wide	640lm	3000K	0,8	○ bianco/white	2898/J/BI
					● nero/black	2898/J/NE

CRI>90

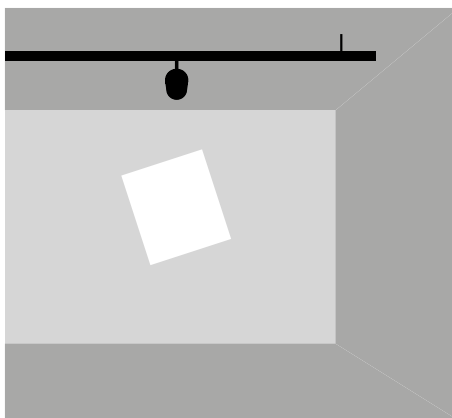
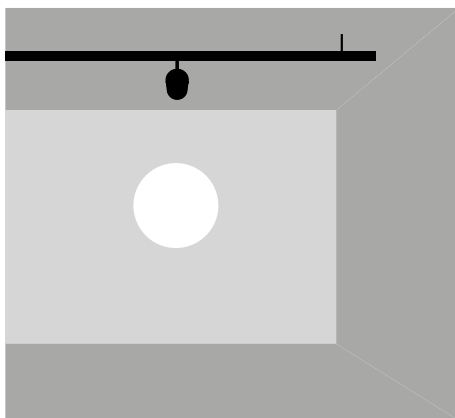
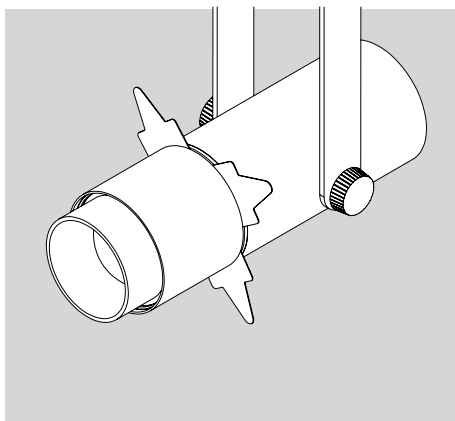
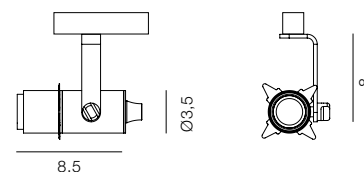
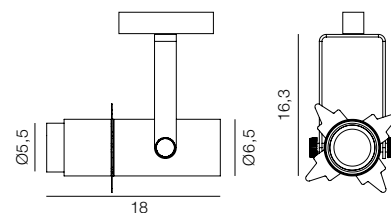





SPOTTÒ



Un apparecchio come un proiettore teatrale di grandi dimensioni orientabile, con alette frangiluce. Una luce d'accento con una sorgente di luce a LED bianco o RGB. Disponibile con adattatore per binario elettrificato o con base a treppiede in metallo verniciato, nella versione da terra.

An adjustable device that recalls a large sized theater projector with anti-glare louver. An accent light with a white or RGB LED light source. Available with adapter for electrified track or with a tripod base in painted metal, in the floor version.

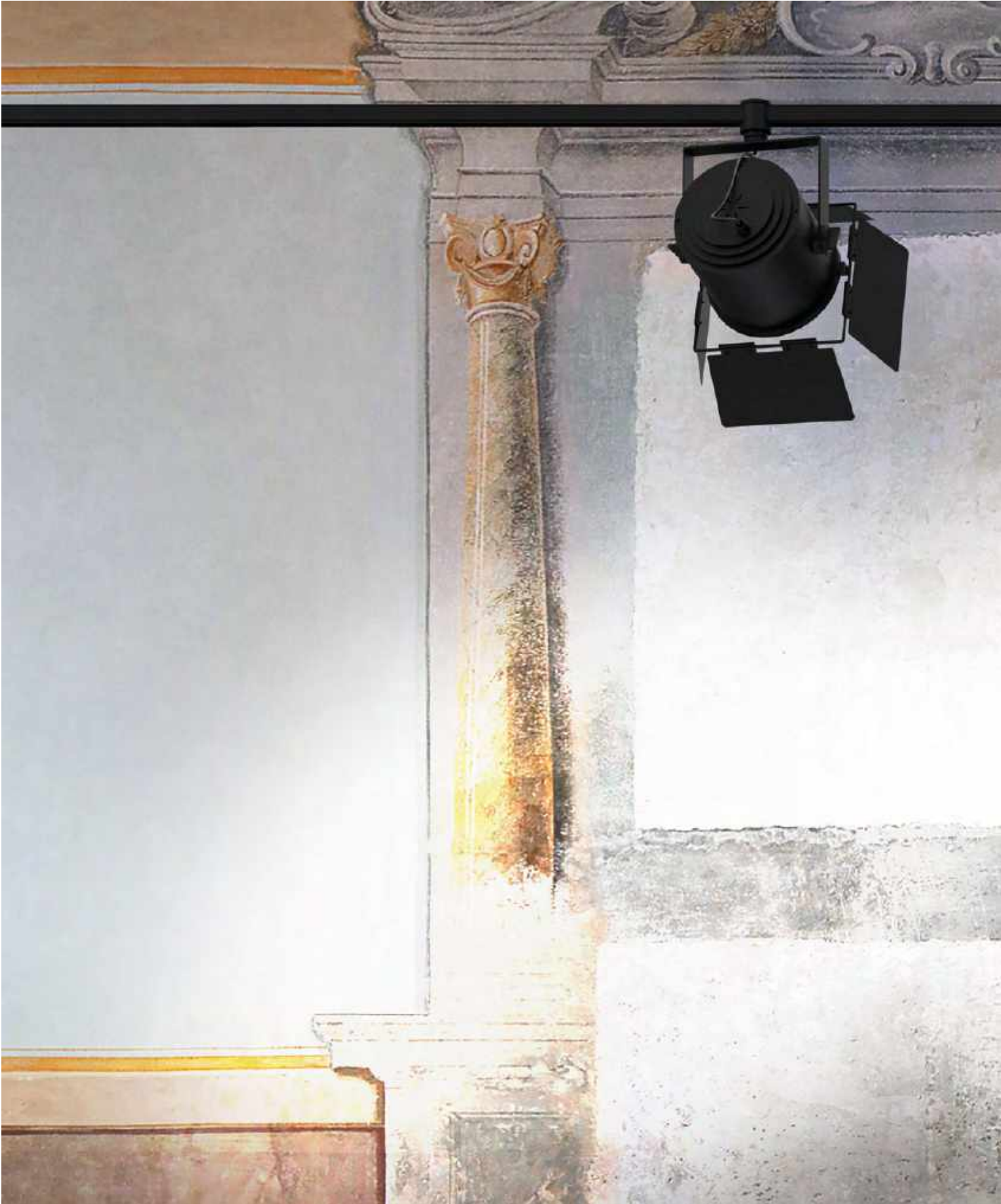







SPOTTÒ

per binario elettrificato / for electrified track

Apparecchio a luce diretta, orientabile e girevole sul supporto di attacco, con adattatore per binario elettrificato 230V. Struttura in alluminio con alette frangiluce. Completo di alimentatore elettronico dimmerabile con telecomando. Sorgente di luce a LED integrata.

Direct light device, adjustable and rotating on the attachment support, with adapter for 230V electrified track. Painted aluminium structure with anti-glare louver flaps. Complete with electronic dimmable driver with remote control. Integrated LED light source.

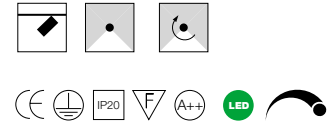

watt	flusso/flux	CCT	Kg	colore/colour	codice/code
30W 230V	4000lm	3000K	4,5	● nero/black	1390/L/1/BE/NE

dimmerabile e con telecomando / dimmable and with remote control

per il binario elettrificato vedi pagine 354-355 / for electrified track see pages 354-355

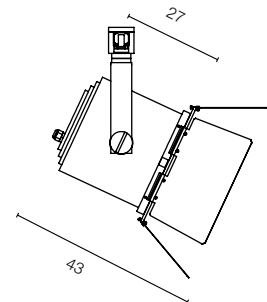
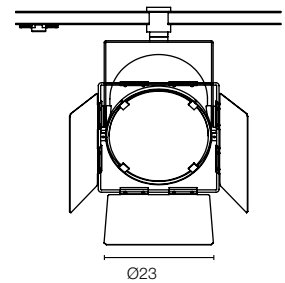



SPOTTÒ

terra / standing

Apparecchio a luce diretta orientabile da terra con supporto girevole in metallo, regolabile in altezza e base a treppiede, verniciato nel colore nero.
Sorgente di luce a LED integrata.
Completo di alimentatore elettronico con alette frangiluce e telecomando.

Adjustable direct floor device with height-adjustable metal swivel base and tripod base, painted black.
Integrated LED light source.
Complete of electronic driver with anti-glare louver flaps and remote control.

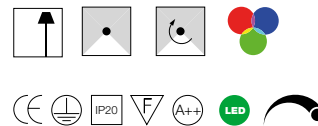

watt	flusso/flux	CCT	Kg	colore/colour	codice/code
------	-------------	-----	----	---------------	-------------

SPOTTÒ					
30W 230V	4000lm	3000K	15	● nero/black	2277/L/1/NE

dimmerabile e con telecomando / dimmable and with remote control

SPOTTÒ RGB					
30W RGB 230V	2500lm	3000K	15	● nero/black	2277/L/NE

dimmerabile e con telecomando / dimmable and with remote control

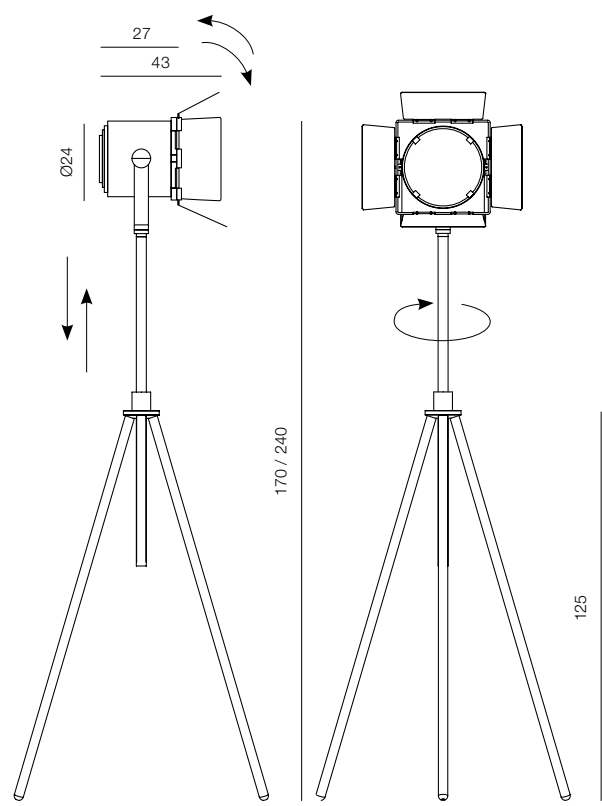





Binari elettrificati

Electrified tracks



Una serie di binari elettrificati di varie lunghezze, di dimensioni ridotte, a 48V e 230V. Nelle varianti da fissare al soffitto, a parete, a sospensione, ad incasso, per supportare i vari spot orientabili con i relativi attacchi: Riccio, Sistema U, Grillo, Bombo, Cip per binario 48V. R19, R11, S20, R14 e Spottò per binario 230V. Particolari giunti di connessione permettono al binario di seguire lo spazio architettonico.

A series of electrified tracks in different lengths and with reduced dimensions, at 48V and 230V. To be fixed to the ceiling, the wall, suspended, recessed, to support the different adjustable spotlights: Riccio, Sistema U, Grillo, Bombo, Cip for 48V track. R19, R11, S20, R14 and Spottò for 230V. Special connection joints allow the track to follow the architectural space.





BINARIO ELETTRIFICATO / ELECTRIFIED TRACK 230V

Binario elettrificato a 230V da sospendere o da fissare al soffitto. In alluminio anodizzato nero o bianco, e completo di vari componenti.
Predisposto per i faretti R19, R11, R14 e Spottò.

230V electrified track suspended or to be fixed to the ceiling, in black anodized or white aluminium, and complete with various components.
Pre-arranged to fix R19, R11, R14 and Spottò spotlights.



binario/track	Kg	colore/colour	codice/code
---------------	----	---------------	-------------

BINARIO ELETTRIFICATO A SOSPENSIONE - SOFFITTO / HANGING - CEILING ELECTRIFIED TRACK



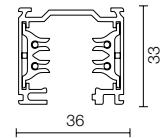

binario / track 100 cm	1,2	○ bianco/white	5955/BI
		● nero/black	5955/NE
binario / track 200 cm	2,4	○ bianco/white	5956/BI
		● nero/black	5956/NE
binario / track 300 cm	3,6	○ bianco/white	5957/BI
		● nero/black	5957/NE

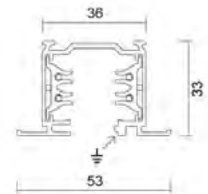

disponibile su richiesta binario ad incasso / the recessed track is available on request

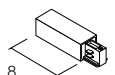
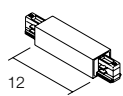
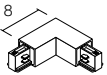
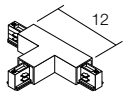
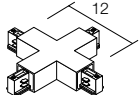

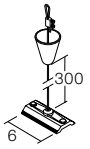

		Kg	colore/colour	codice/code
SINGOLI COMPONENTI / SINGLE COMPONENTS				
	alimentazione destra / right power supply	0,1	○ bianco/white ● nero/black	5958/BI 5958/NE
	alimentazione sinistra / left power supply	0,1	○ bianco/white ● nero/black	5959/BI 5959/NE
	giunto lineare intermedio / intermediate linear joint	0,1	○ bianco/white ● nero/black	5960/BI 5960/NE
	giunto d'angolo a L / L-angle joint	0,1	○ bianco/white ● nero/black	5961/BI 5961/NE
	giunto d'angolo a T / T-angle joint	0,1	○ bianco/white ● nero/black	5962/BI 5962/NE
	giunto a croce / cross joint	0,1	○ bianco/white ● nero/black	5963/BI 5963/NE
	testata di chiusura / terminal head	0,1	○ bianco/white ● nero/black	5964/BI 5964/NE
	cavetto di sospensione con rosone terminale hanging cable with terminal ceiling rose (3 m)	0,1	○ bianco/white ● nero/black	5965/BI 5965/NE
	supporto morsetto per attacco al soffitto ceiling connector	0,1		5967

BINARIO ELETTRIFICATO / ELECTRIFIED TRACK

48V

Un binario di piccole dimensioni, in diverse lunghezze. Sospeso o fissato al soffitto, e unito tramite giunti lineari, e ad angolo retto è possibile seguire ed illuminare percorsi e ambienti professionali con una luce d'accento o diffusa. Predisposto per i faretti Riccio, Sistema U, Grillo, Bombo e Cip e per i moduli a luce diffusa o UGR.

A small-sized track, in different lengths. Suspended or fixed to the ceiling, joined through linear joints, and at a 90° angle, it is possible to follow and illuminate pathways and professional environments with accent or diffused light. Pre-arranged to fix Riccio, Sistema U, Grillo, Bombo and Cip spotlights and modules with diffused light or UGR versions.



binario/track	Kg	colore/colour	codice/code
---------------	----	---------------	-------------

BINARIO ELETTRIFICATO A SOSPENSIONE - SOFFITTO / HANGING - CEILING ELECTRIFIED TRACK

binario / track	L100 48V	0,8	○ bianco/white	519.1J
			● nero/black	519J
binario / track	L200 48V	1,6	○ bianco/white	520.1J
			● nero/black	520J
binario / track	L300 48V	2,4	○ bianco/white	521.1J
			● nero/black	521J

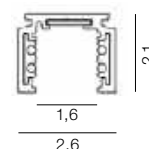

BINARIO ELETTRIFICATO A INCASSO / BUILT-IN ELECTRIFIED TRACK

binario / track	L100 48V	0,8	● nero/black	591J/NE
binario / track	L200 48V	1,6	● nero/black	592J/NE
binario / track	L300 48V	2,4	● nero/black	523J/NE

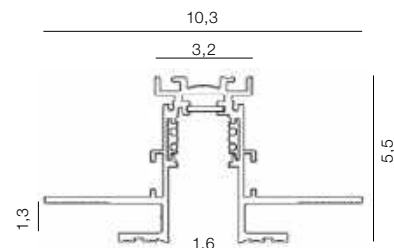

GIUNTI DI CONNESSIONE DEI BINARI / TRACK CONNECTION JOINTS

testata di chiusura / terminal head	0,01	○ bianco/white	523.1J
		● nero/black	523J
giunto lineare / linear joint	0,1	○ bianco/white	524.1J
		● nero/black	524J
giunto 90° / 90° joint	0,1	○ bianco/white	525.1J
		● nero/black	525J
giunto flessibile /flexible joint	0,1	○ bianco/white	544.1J
		● nero/black	544J
cavo di sospensione / hanging cable 1,5 m			526J
testata di alimentazione / feeding unit	0,1		522J
giunto intermedio meccanico / mechanical intermediate joint			547X
giunto terminale meccanico / mechanical terminal joint			548X

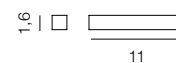
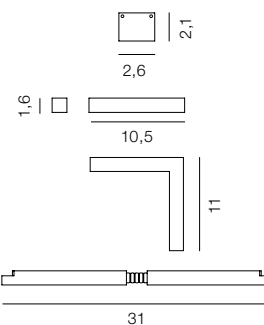

su richiesta il binario a sospensione è disponibile con luce indiretta
on request the suspension track is also available with indirect light

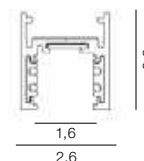



ALIMENTATORE REMOTO / REMOTE DRIVER

60W 230/48	0,5	5142.3
100W 230/48V	0,6	5142.1
200W 230/48V	1	5142.2

ROSONE CON ALIMENTATORE / CEILING ROSE WITH DRIVER

100W 230/48V	35x8 H5 cm	1,5	<input type="radio"/> bianco/white	40086/BI
			<input type="radio"/> nero/black	40086/NE
200W 230/48V	35x8 H5 cm	1,9	<input type="radio"/> bianco/white	40086.1/BI
			<input type="radio"/> nero/black	40086.1/NE

La scelta del codice del rosone è legato alla somma dei Watt dei singoli spot.
The choice of the ceiling rose code is related to the watts sum of the different spots.

BLUETOOTH

dispositivo Casambi bluetooth per la dimmerazione indipendente di ogni singolo faretto - in abbinamento ai faretto dimmerabili - (Casambi app. iOS e Android free) 545J 
bluetooth device for an independent dimming of each individual spotlight together with dimmable spotlights (Casambi app. iOS e Android free)

dispositivo bluetooth per la dimmerazione del binario elettrificato 48V da ordinare in abbinamento ai faretto (ON/OFF) non dimmerabili 500X
bluetooth device to dimmer the 48V electrified track to be ordered together with the non dimmable (ON/OFF) spotlights

MODULI per binario elettrificato 48V / MODULES for 48V electrified track



Moduli da fissare al binario elettrificato, disponibili in due versioni: a luce diffusa con schermo opalino, o a luce diretta con riflettore microprismatico che aumenta l'efficienza luminosa, con UGR<19. I moduli sono in due lunghezze e con LED nella temperatura di colore (2700-4000K), con una alta resa cromatica e con CRI>90. Moduli in altre lunghezze, con temperatura di colore a 3000K, e orientabili su richiesta.

Modules to be fixed to the electrified track, available in two versions: diffused light with opal screen or direct light with microprismatic screen, which increases luminous efficiency, with UGR<19. The modules are in two lengths and with LED with colour temperature (2700-4000K), with high colour rendering and CRI>90. Modules in other lengths, with colour temperature at 3000K, and adjustable are available on request.

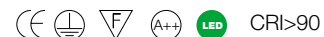

watt flusso/flux CCT dimension Kg colore/colour codice/code

MODULI DI LUCE LINEARE / LINEAR LIGHT MODULES

moduli con diffusore opalino / opal diffuser module

6W 48V 744lm 3000K L28,6 cm

○ bianco/white 565.1J

● nero/black 565J

29,8W 48V 3720lm 3000K L141 cm

○ bianco/white 567.1

● nero/black 567J

moduli con diffusore UGR / UGR diffuser module

5,6W 48V 579lm 3000K L28,6 cm

○ bianco/white 566.1J

● nero/black 566J

18,2W 48V 2087lm 3000K L113 cm

○ bianco/white 597.1J

● nero/black 597J

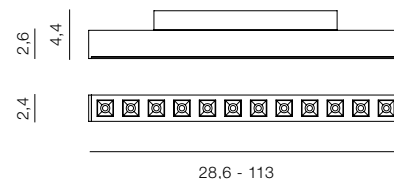
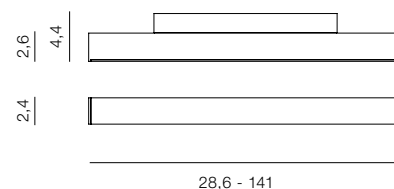

su richiesta disponibile a 2700K e 4000K e con schermo prismatico
on request also available with 2700K and 4000K and with prismatic screen

diffusore opalino / opal diffuser L28,6

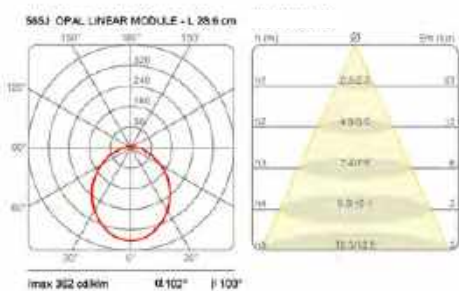

diffusore opalino / opal diffuser L141

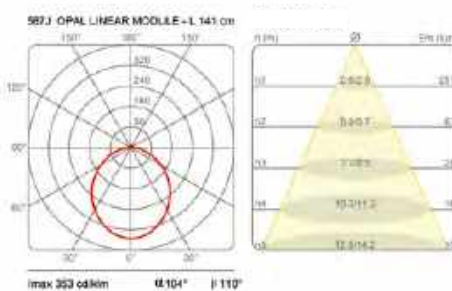

diffusore UGR / UGR diffuser L28,6

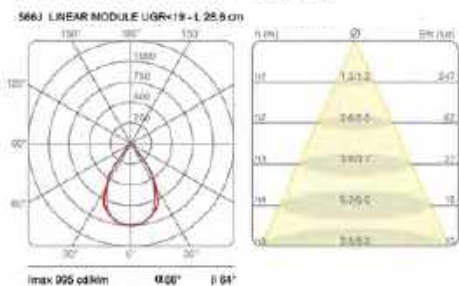

diffusore UGR / UGR diffuser L113

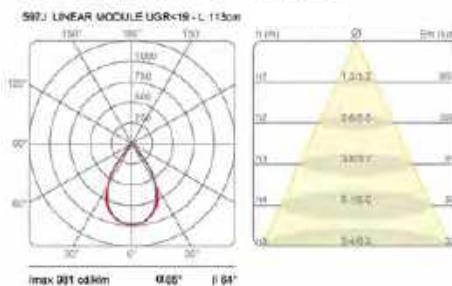



moduli a luce diffusa o con riflettore UGR da fissare al binario.

diffused light modules or with UGR diffuser to be fixed to the track.



ACCESSORIO / ACCESSORY

accessorio paraluce della lunghezza dei moduli.

modulo 28,6cm	40168/GI
modulo 113cm	40168.1/GI
modulo 141cm	40168.2/GI

lens hood accessory of the modules length.

module 28.6 cm	40168/GI
module 113 cm	40168.1/GI
module 141cm	40168.2/GI





2003



Essenziale nel design che ne esalta la funzionalità. Due forme geometriche, un cilindro e una parabola collegati al dissipatore formano una grande sospensione a luce diretta e indiretta con sorgente di luce a LED.

Un apparecchio a sospensione per un'illuminazione generale da installare in grandi ambienti interni.

Essential design that highlights its functionality. Two geometric shapes, a cylinder and a parabola connected to the heat sink give life to a large direct and indirect light pendant lamp with LED light source.

A suspension light fixture for a general lighting, to be installed in large internal areas.



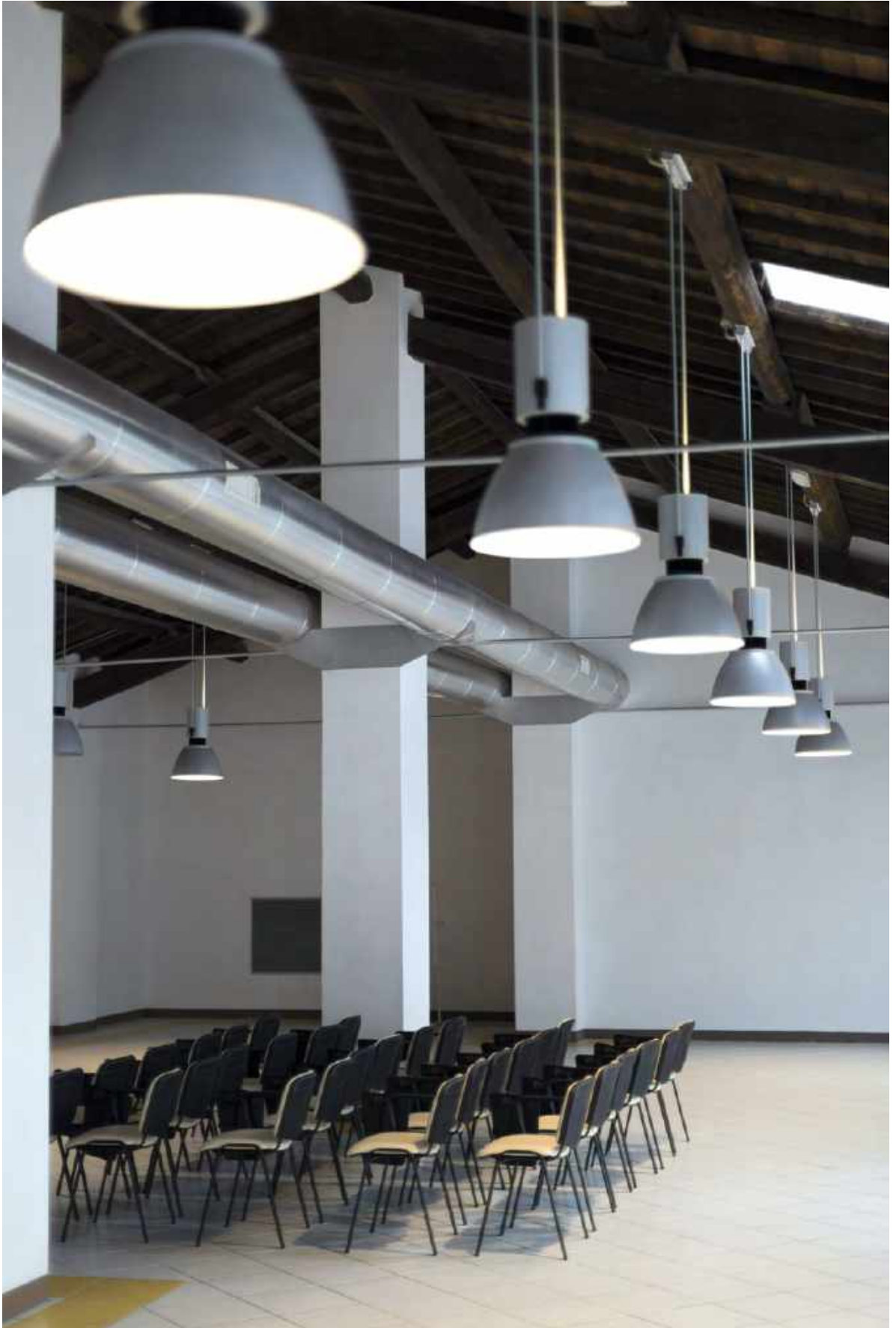

2003

Apparecchio a sospensione a luce diretta/ indiretta. Struttura in alluminio verniciato, particolari in resina nel colore nero. Sorgente di luce a LED integrata. Alimentatore dimmerabile integrato nel corpo della lampada. Dissipatore a vista. Sospeso con tigi in acciaio.

Suspension device, direct and indirect light, grey aluminium structure, black resin details. Integrated LED light source. Integrated dimmable driver inside the body lamp. Visible heatsink. Suspended with steel rods.

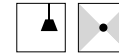

watt	flusso/flux	CCT	Kg	colore/colour	codice/code
luce diretta / direct light 55W 230V	9010lm	3000K	12	● antracite/anthracite	2003/50/DIM/L/1/AN
luce indiretta / indirect light 38W 230V	3200lm	3000K			

alimentatori elettronici dimmerabili / electronic dimmable drivers

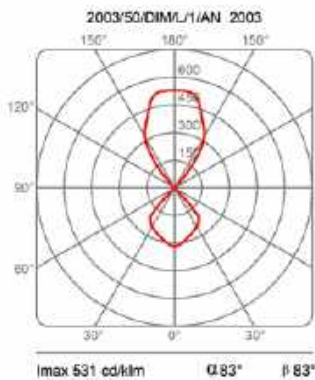
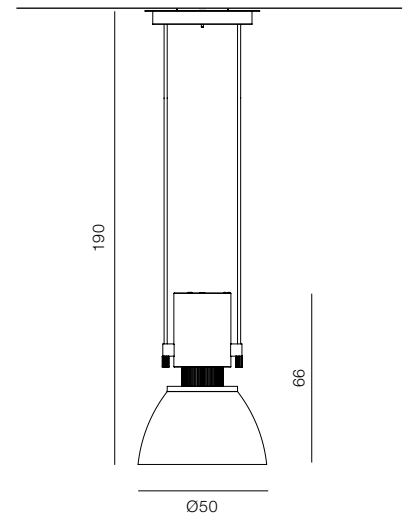





CONDOR



Un supporto in metallo verniciato nel colore rosso fuoco sostiene il dissipatore e una grande parabola. Pensata per grandi spazi espositivi e commerciali. Condor vola alto ed illumina con una elevata efficienza. Disponibile in due diversi diametri.

A metal support painted in flaming red color hold up the heat sink and a large parabola. Designed for large exhibition and commercial environments. Condor flies high and lights up thanks to its high efficiency. Available in two different diameters.





CONDOR

Apparecchio a sospensione a luce diretta.
 Struttura in alluminio nel colore antracite.
 Particolare supporto in alluminio verniciato nel colore rosso.
 Sorgente di luce a LED ad alta efficienza.
 Alimentatore elettronico integrato nel rosone al soffitto.
 Disponibili in due dimensioni.

Direct light suspension device.
 Anthracite aluminium structure.
 Special red lacquered aluminium support.
 High efficiency LED light source.
 Driver integrated in the ceiling rose.
 Available in two dimension.



watt	flusso/flux	CCT	Kg	colore/colour	codice/code
<hr/>					
CONDOR Ø42					
40W 230V	4600lm	3000K	7	● antracite/anthracite	2085/J/DIM/L/1/AN
<hr/>					
CONDOR Ø50					
60W 230V	7000lm	3000K	7	● antracite/anthracite	2085/DIM/L/1/AN

rosone con alimentatore dimmerabile / ceiling rose with dimmable driver Ø 23 H 5,5

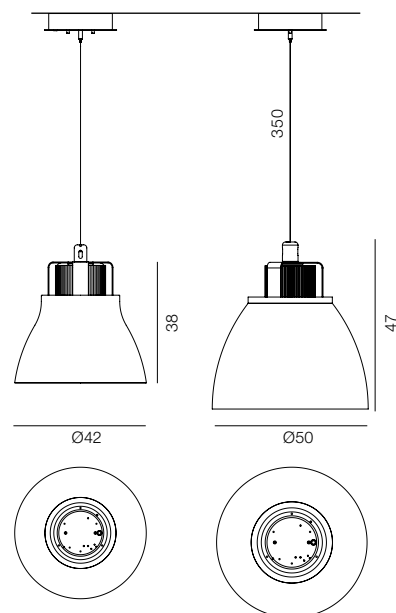

su richiesta il supporto rosso può essere verniciato in altri colori
 on request the red support can be painted with another colors

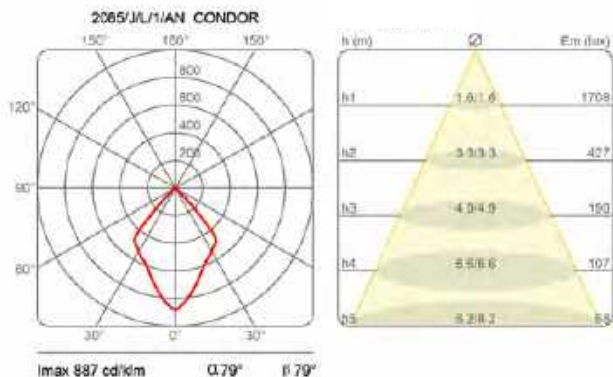



Studio Andreas Oliver Klein, Pietrasanta – LU



NUVOLE VAGABONDE



Una serie di elementi in metacrilato opal bianco, sovrapposti e sfalsati, fissati ad incastro ad una struttura portante in metallo definiscono il volume della lampada e diffondono la luce ridisegnando con le ombre la loro forma. Disponibile in due dimensioni per adattarsi al tuo spazio.

A series of overlapping and staggered elements in white opal methacrylate fixed in interlocked to a supporting metal structure define the lamp volume and diffuse light, redesigning their shape through shadows. Available in two sizes to easily fit your space.





NUVOLE VAGABONDE

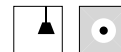

Lampada a sospensione a luce diffusa. Struttura in metallo, elementi diffusori sovrapposti in metacrilato opal bianco e in policarbonato opal bianco nella versione junior. Sospesa con cavi in acciaio fissati al rosone di attacco al soffitto. Per lampadine a LED. Disponibile in tre misure.

Suspension lamp with diffused light. Metal structure, diffusing superimposed elements in white opal methacrylate and white opal polycarbonate in the junior version. Fixed with steel cable to the ceiling rose. For LED bulbs. Available in three sizes.

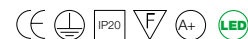

watt	CCT	Kg	colore/colour	codice/code
4x18W E27 230V	3000K	20	○ bianco/white	2011/110/2/L/1/BI

rosone / ceiling rose Ø26,5 H8

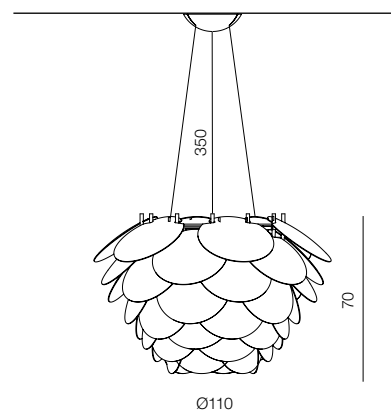

3x15W E27 230V	3000K	10	○ bianco/white	2011/80/L/1/BI
----------------	-------	----	----------------	----------------

su richiesta / on request

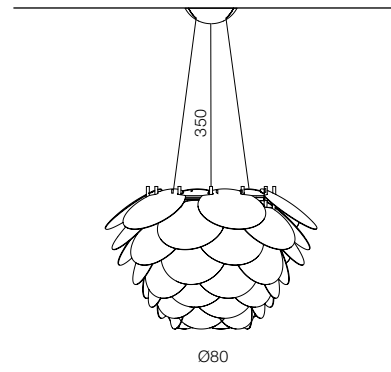

1x18W E27 230V	3000K	3,5	○ bianco/white	2011J
----------------	-------	-----	----------------	-------

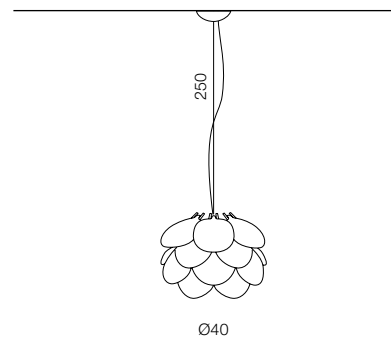





SOUND

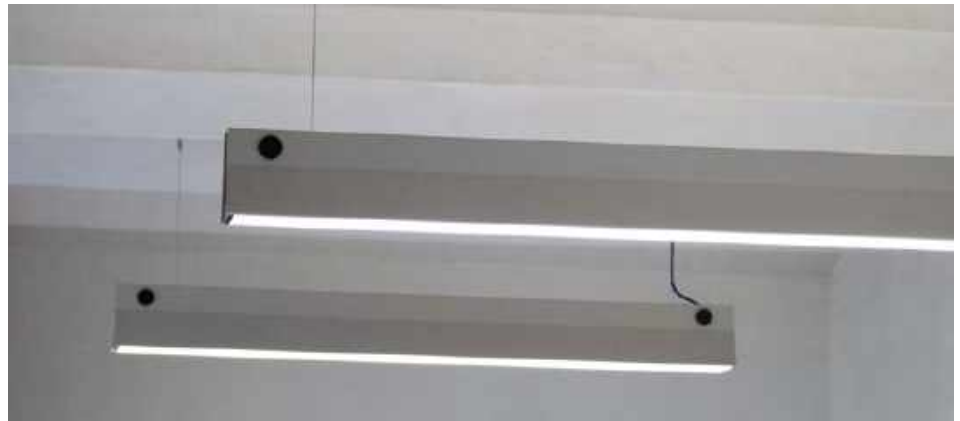

Un apparecchio lineare a luce diretta diffusa, per sorgente di luce a LED. Per uffici, scuole e spazi che richiedono efficienza luminosa ed un elevato comfort. Struttura in alluminio, con un particolare schermo prismatico per il controllo dell'abbagliamento.

A linear device with diffused direct light, for LED light source. Ideal for offices, schools and spaces requiring a particular luminous efficiency and a high level of comfort. Aluminium structure with a special prismatic anti-glare screen.





SOUND

Lampada a sospensione a luce diretta diffusa.
 Struttura in alluminio verniciato nel colore grigio con pomelli e particolari nel colore grigio scuro. Diffusore trasparente prismatico antiabbagliamento.
 Sorgente di luce a LED integrata e alimentatori elettronici dimmerabili inseriti all'interno del corpo lampada.

Suspended lamp with direct and diffused light.
 Grey lacquered aluminium structure, dark grey lacquered knobs.
 Anti-glare prismatical and transparent diffuser.
 Integrated LED light source and dimmable electronic drivers placed inside the body lamp.



UGR < 19

watt	flusso/flux	CCT	Kg	colore/colour	codice/code
60W 230V	5900lm	3000K	5,5	grigio-grigio scuro grey-dark grey	2098/DIM/L/1/GR

rosone / ceiling rose Ø10 H3
 alimentatori elettronici dimmerabili / electronic dimmable drivers

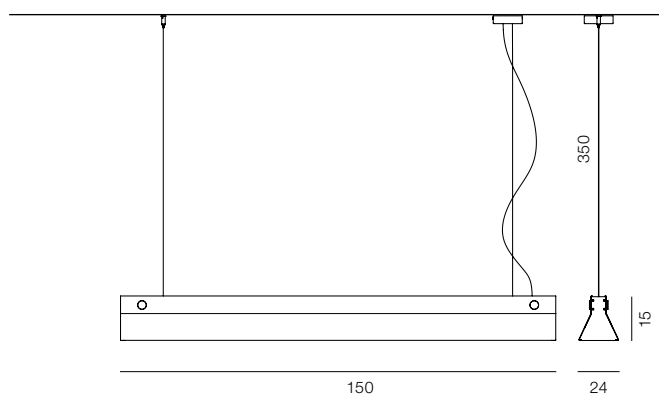

a richiesta è possibile realizzare il corpo lampada e i pomelli in altri colori
 on request it is possible to made the body lamp and the knobs in other colors

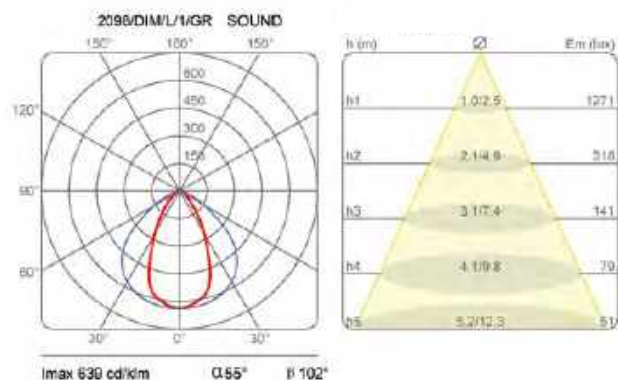





CRAB



Una lampada dal forte carattere.
Una sospensione a luce diretta da
installare in ambienti interni.
Una forma caratterizzata da lame
che, come chele di un granchio,
avvolgono la sfera che emana una
luce d'accento.

A lamp with a strong character.
An indoor suspension with direct
light.
A sphere radiating an accent light,
surrounded by blades, which
remind a crab claws.





CRAB

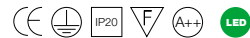

CRI>90

UGR<19

Lampada a sospensione a luce diretta.
Formata da lamelle in alluminio tagliate a laser fissate a un supporto centrale e da una sfera dissipatore in alluminio che contiene la sorgente di luce a LED.
Struttura verniciata nel colore bianco e sfera grigia o grigio scuro e sfera grigia.
Alimentatore integrato nel rosone da fissare al soffitto.

Suspension lamp with direct light.
Formed by laser-cut aluminium slats fixed to a central support and by an aluminium dissipating sphere which contains the LED light source.
Structure painted in white and sphere in grey colour or dark grey and sphere in grey colour.
Driver integrated in the rose, to be fixed to the ceiling.

watt	fascio/beam	flusso/flux	CCT	Kg	colore/colour	codice/code
17,8W 230V	narrow	2405lm	3000K	2,7	● bianco - grigio white - grey	21009/BI
					● grigio scuro - grigio dark grey - grey	21009/GR

rosone con alimentatore / ceiling rose with driver Ø12 H4,5

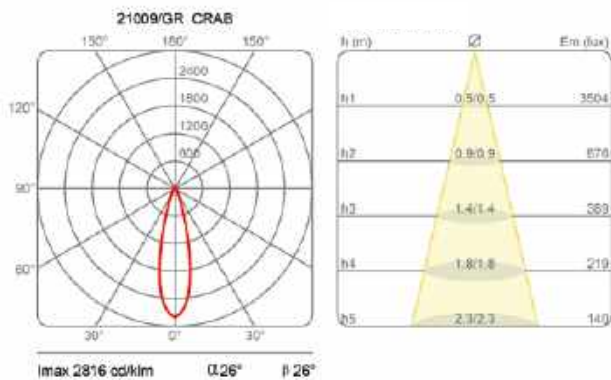
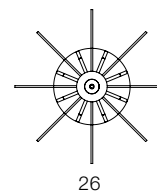
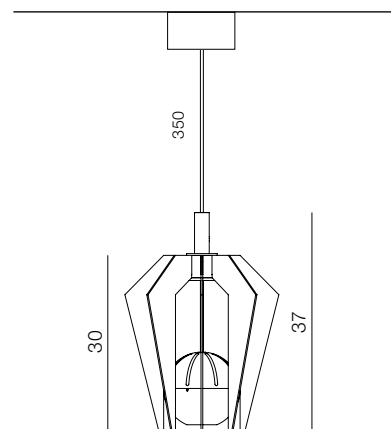

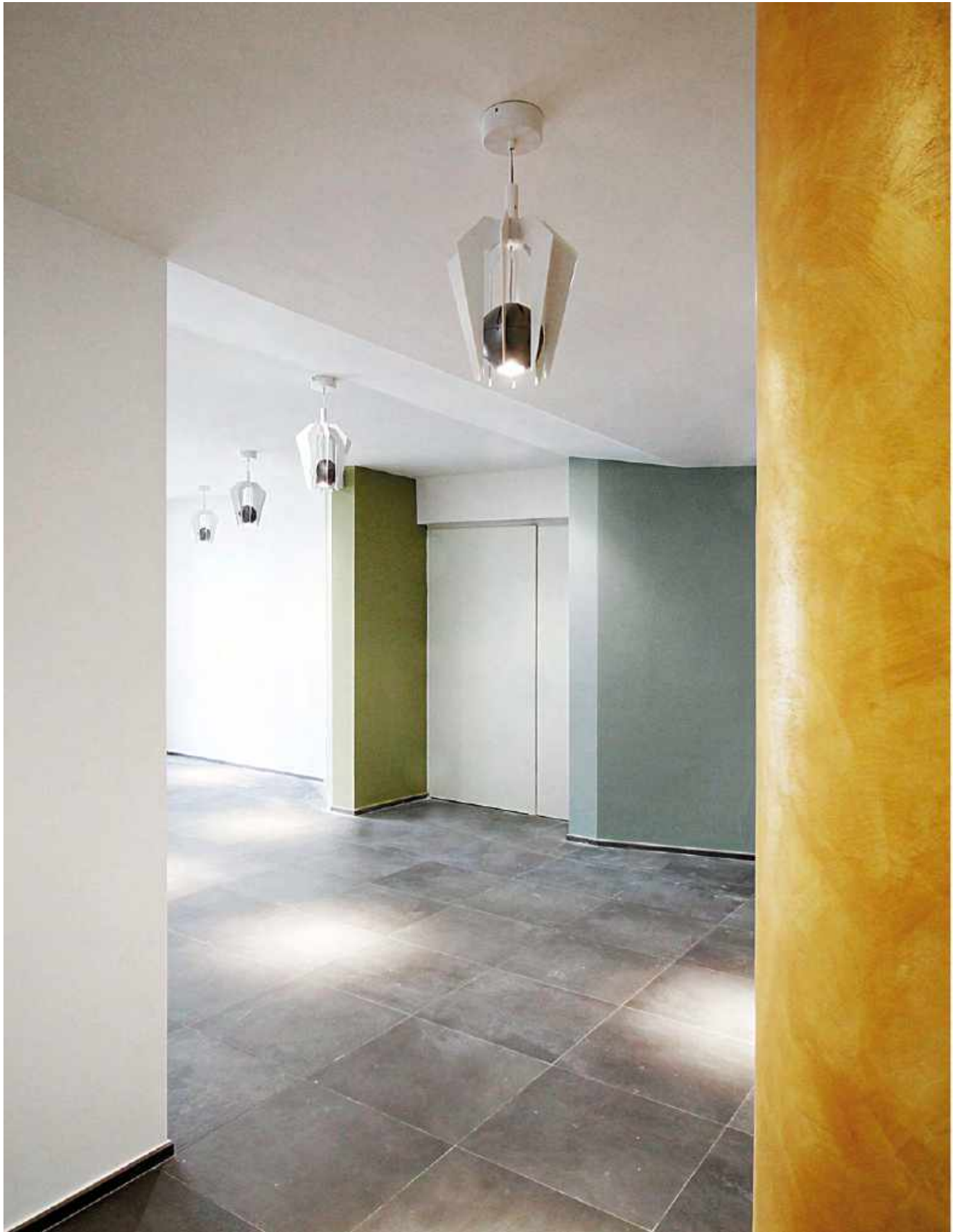



CORONA



Una lampada rotonda, minimalista per sorgente di luce a LED ad alta efficienza luminosa.

Una luce diretta, per l'installazione a soffitto.

Si integra nell'ambiente nelle diverse situazioni, sia in ambito residenziale che professionale.

A round minimalist lamp for LED light source with a high luminous efficiency.

A direct LED light to be mounted to the ceiling. The lamp integrates into the environment in various situations both in residential and professional settings.

CORONA

Apparecchio da soffitto a luce diretta.
 Struttura in alluminio, guarnizione in gomma e diffusore in vetro satinato.
 Sorgente di luce a LED integrata.
 Completo di alimentatore elettronico dimmerabile.
 Disponibile anche nella versione in metacrilato e in tre dimensioni (vedi catalogo lampade).

Ceiling lamp with direct light.
 Painted aluminium structure, rubber protection gasket and satin glass diffuser.
 Integrated LED light source. Complete of dimmable electronic driver.
 Also available in methacrylate version and in three sizes (see lamps catalog).



IP44

watt	flusso/flux	CCT	Kg	colore/colour	codice/code
28W 230V	3000lm	3000K	4	○ bianco/white	2834/P/L/1/BI

alimentatore elettronico dimmerabile / dimmable electronic driver.

IP44

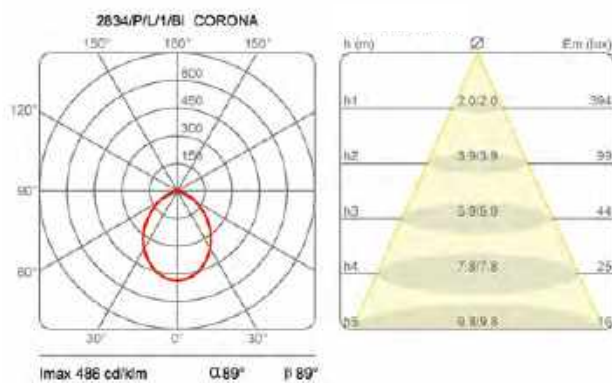
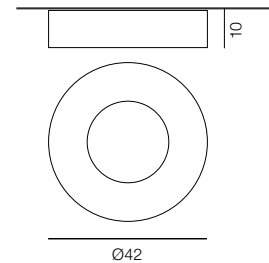



COOP, Bagnolo in piano, Reggio Emilia – Studio Inres



HOLE-LIGHT



Una lampada a luce diffusa
in polietilene stampata con la
tecnologia rotazionale.
Sorgente di luce LED.
Installazione a soffitto per
illuminare percorsi, spazi pubblici
e domestici.

A diffused light lamp in
polyethylene, molded using
rotational technology.
LED light source. Ceiling mounting
to illuminate pathways, public and
domestic environments.

HOLE-LIGHT



Apparecchio da soffitto a luce diffusa.
 Struttura stampata in rotazionale, materiale polietilene nel colore bianco, base in alluminio verniciato nel colore bianco.
 Completo di alimentatori elettronici dimmerabili all'interno del corpo lampada.

Ceiling device with diffused light.
 Structure printed with rotational moulding technology, white polyethylene material, white aluminium support and ceiling box.
 With electronic dimmable drivers inside the body lamp.



watt	flusso/flux	CCT	Kg	colore/colour	codice/code
21W 230V	2650lm	3000K	3	○ bianco/white	2875/J/DIM/L/1/BI

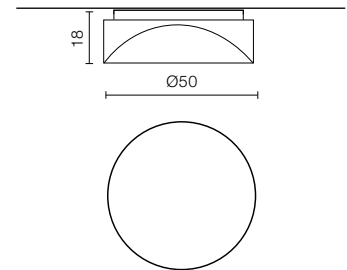

alimentatori elettronici dimmerabili / electronic dimmable drivers

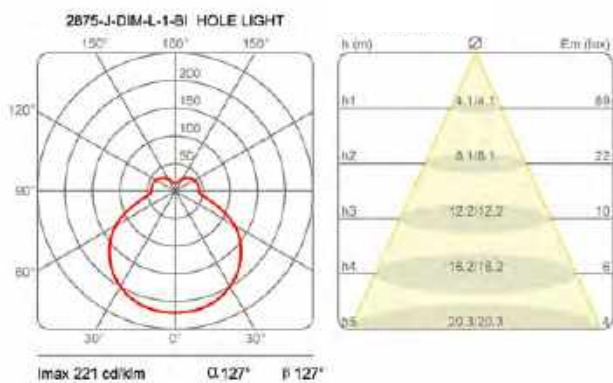





Q8-Q8HP

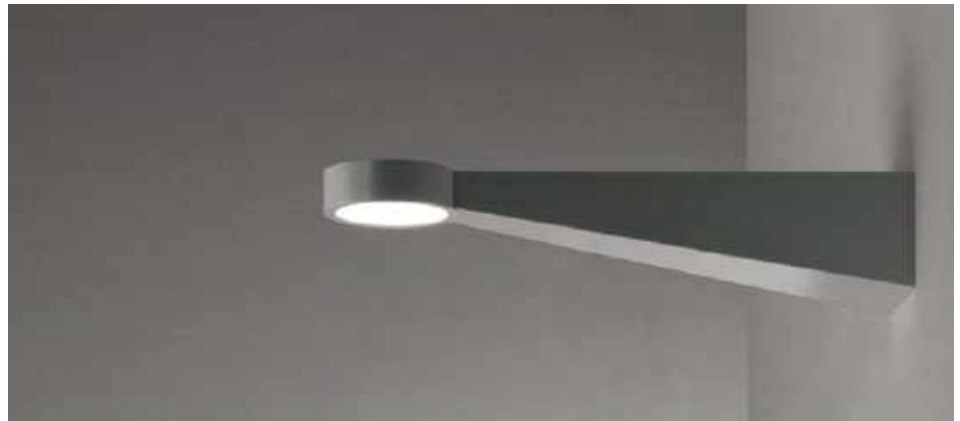

Una famiglia di apparecchi da parete caratterizzati dal forte aggetto e dalla struttura robusta. Disponibili nelle versioni a luce diretta, indiretta e diretta/indiretta. Sorgente di luce a LED dimmerabile. Da utilizzare nelle diverse esigenze di illuminazione, in particolare per soffitti alti e a volta.

A family of wall lighting devices characterized by their strong overhang and a robust structure. Available in multiple light versions: direct, indirect and direct/indirect light. Dimmable LED light source. Can be used in a variety of lighting needs, especially for high and vaulted ceilings.

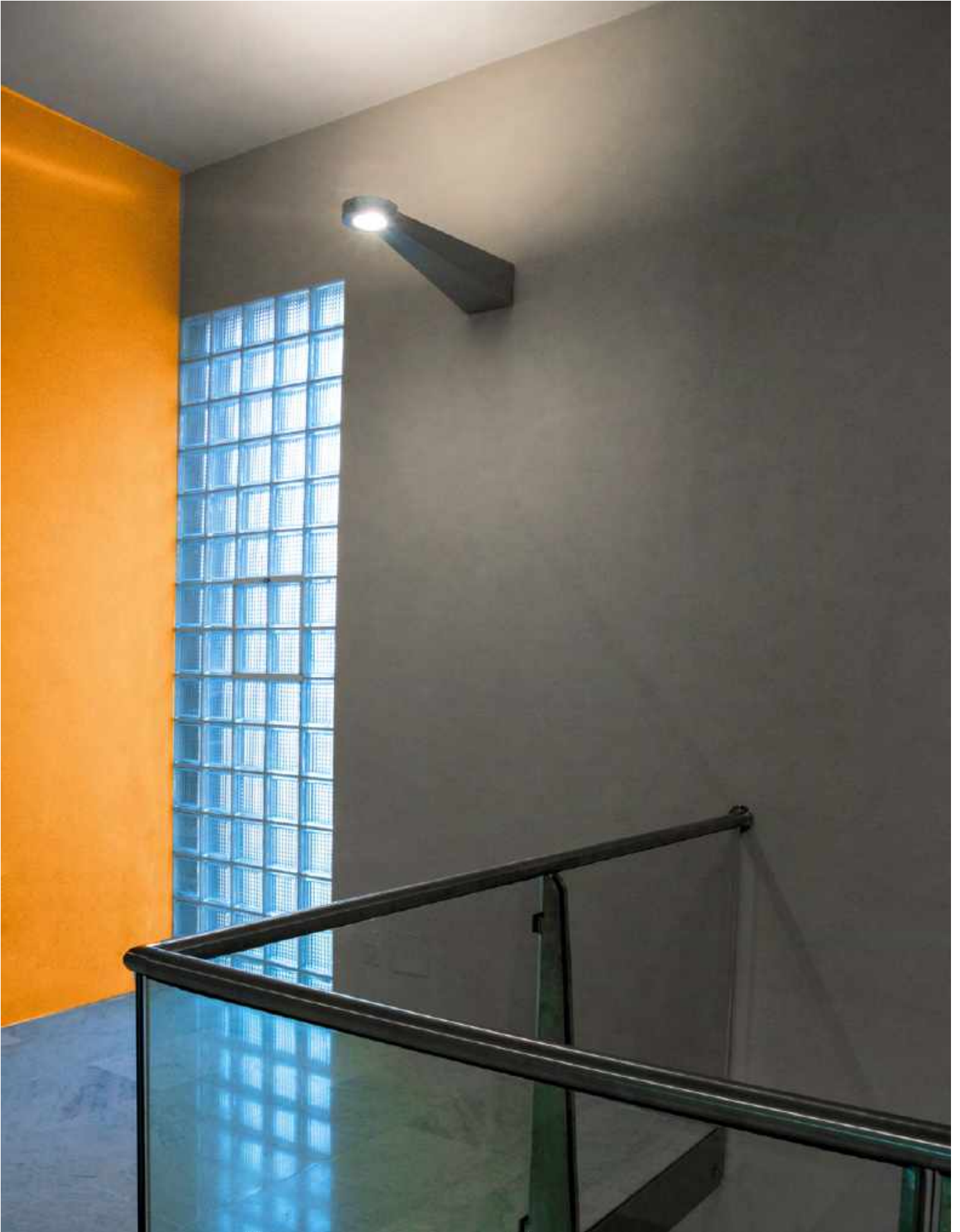



Ostello della gioventù, Volterra, Pisa





Q8

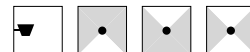

Un apparecchio da parete a luce diretta, indiretta e diretta/indiretta. Struttura in metallo verniciato nel colore bianco.
Sorgente di luce a LED dimmerabile.
Alimentatore elettronico integrato nel corpo della lampada.

Wall device with direct light, indirect light and direct/indirect light. White painted metal structure.
Dimmable LED light source.
Electronic driver integrated in the body lamp.



watt fascio/beam flusso/flux CCT Kg colore/colour codice/code

LUCE DIRETTA E INDIRETTA / DIRECT AND INDIRECT LIGHT (/DI)

2x14W 230V very wide 2x1750lm 3000K 5 ○ bianco/white 1296/DI/DIM/L/1/T/BI

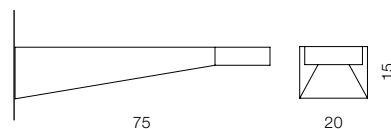

LUCE DIRETTA / DIRECT LIGHT (/D)

25W 230V very wide 2600lm 3000K 5 ○ bianco/white 1296/D/DIM/L/1/T/BI

LUCE INDIRETTA / INDIRECT LIGHT (/I)

25W 230V very wide 2600lm 3000K 5 ○ bianco/white 1296/I/DIM/L/1/T/BI

alimentatori elettronici dimmerabili integrati nel corpo lampada
electronic dimmable drivers integrated in the body lamp

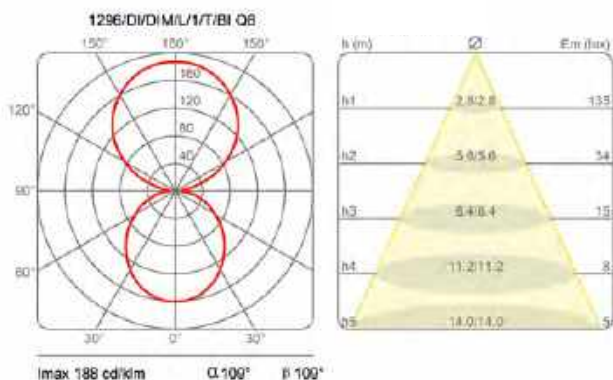



Q8-HP

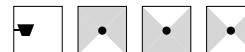

Un apparecchio da parete a luce diretta, indiretta e diretta/indiretta. Una struttura dal forte carattere in metallo verniciato nel colore bianco. Sorgente di luce a LED dimmerabile. Alimentatore elettronico integrato nel corpo della lampada.

Wall lamp with direct light, indirect light and direct/indirect light. Strong character white painted metal structure. Dimmable LED light source. Electronic driver integrated in the body lamp.

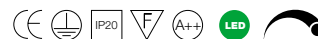

watt	flusso/flux	CCT	Kg	colore/colour	codice/code
LUCE DIRETTA E INDIRETTA / DIRECT AND INDIRECT LIGHT					
luce diretta/direct light 24W 230V	3675lm	3000K	4	○ bianco/white	1296/HP/DI/DIM/L/1/BI
luce indiretta/indirect light 21W 230V	3150lm	3000K			
LUCE DIRETTA / DIRECT LIGHT					
56W 230V	6400lm	3000K	4	○ bianco/white	1296/HP/D/DIM/L/1/BI
LUCE INDIRETTA / INDIRECT LIGHT					
35W 230V	4600lm	3000K	4	○ bianco/white	1296/HP/I/DIM/L/1/BI

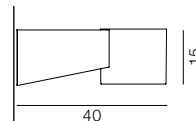
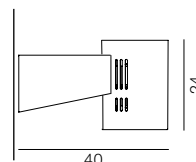

alimentatori elettronici dimmerabili integrati nel corpo lampada
 electronic dimmable drivers integrated in the body lamp



luce diretta e indiretta / direct and indirect light

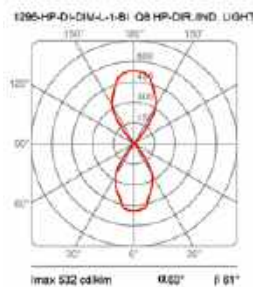

luce diretta / direct light

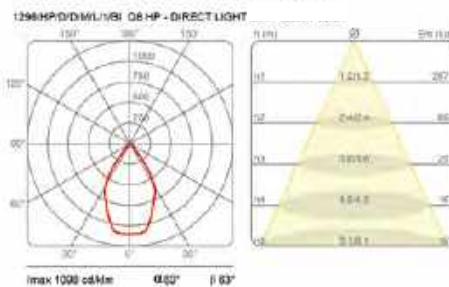

luce indiretta / indirect light

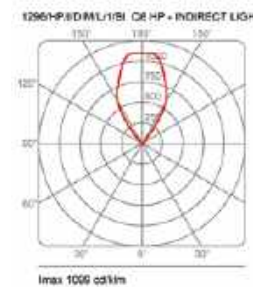





OLYMPIC



Una struttura in metallo verniciato con un forte aggetto, un dissipatore a vista che sorregge il grande diffusore in vetro satinato, formano la lampada. Un'illuminazione diffusa con sorgente di luce a LED per spazi residenziali, commerciali e zone di ricevimento.

The lamp is made up of a fixture in painted metal with a strong overhang, a visible heat sink in full view that supports the large satin glass diffuser. A diffused lighting with LED light source for residential, commercial and reception areas.

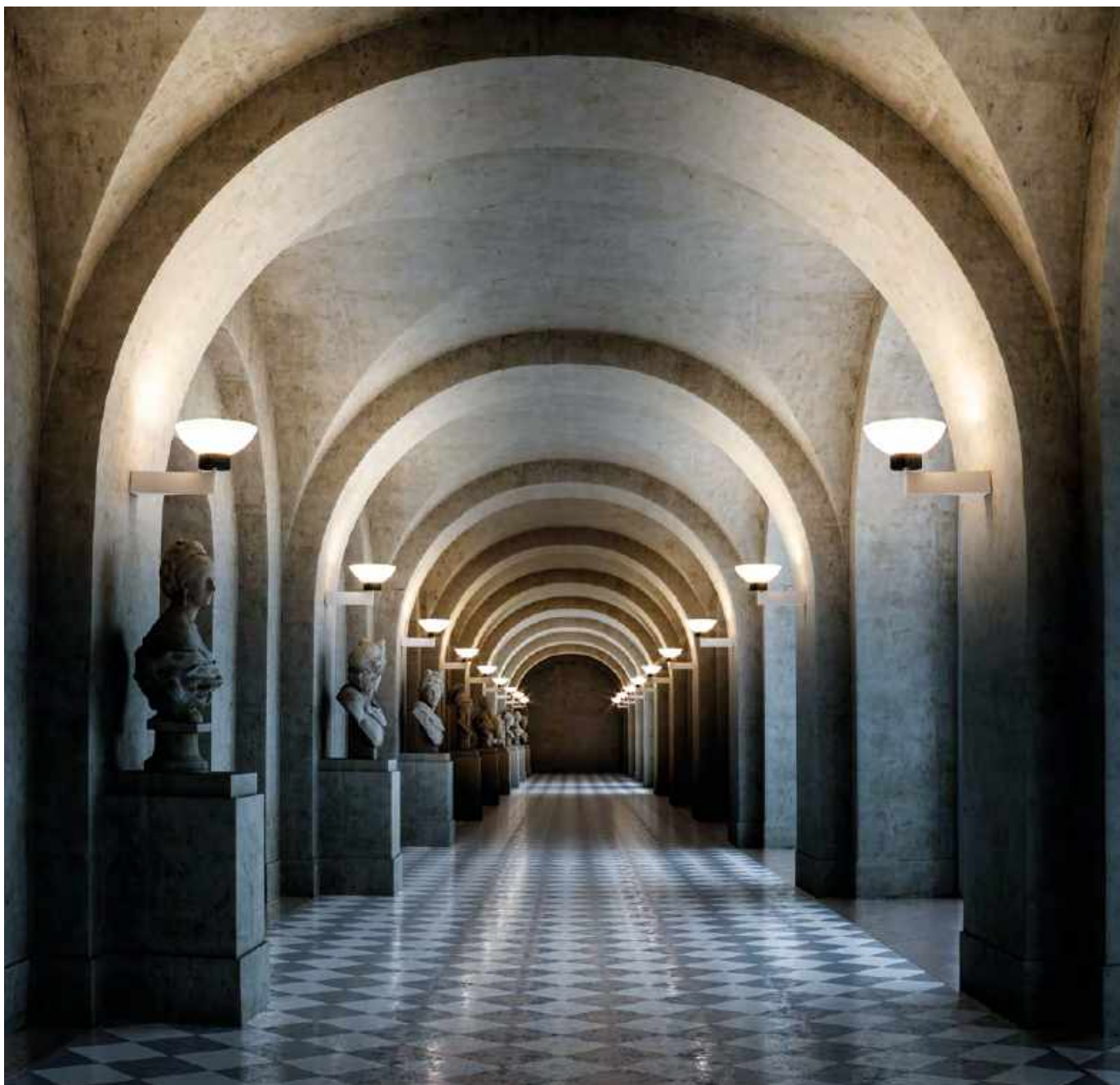

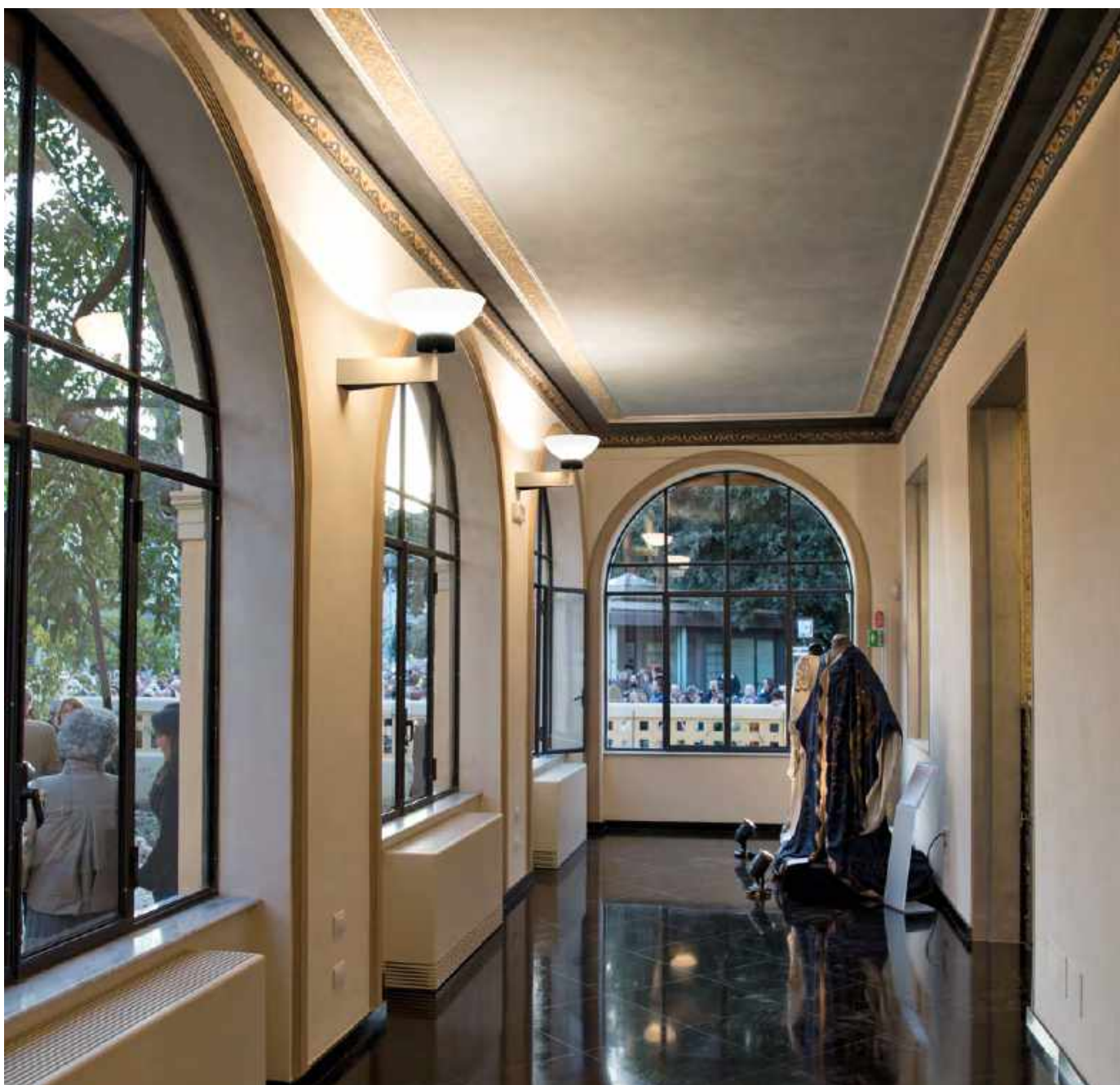

Villa Argentina, Viareggio

OLYMPIC

Lampada da parete a luce diffusa.
 Struttura in metallo verniciato, dissipatore
 in alluminio a vista che garantisce il
 raffreddamento della sorgente di luce a LED e
 diffusore in vetro satinato.
 Alimentatore elettronico dimmerabile integrato.

Wall lamp with diffused light.
 Metal painted structure, visible aluminium
 heat sink that guarantees LED light source
 cooling and satin glass diffuser.
 Dimmable electronic driver.

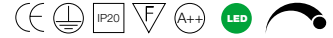

watt	flusso/flux	CCT	Kg	colore/colour	codice/code
30W 230V	3900lm	3000K	5,6	○ bianco/white	1290/DIM/L/1/BI
				● antracite/anthracite	1290/DIM/L/1/AN

alimentatore elettronico dimmerabile integrato nel corpo lampada
 electronic dimmable driver integrated in the body lamp

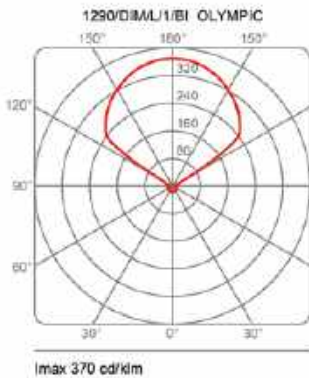
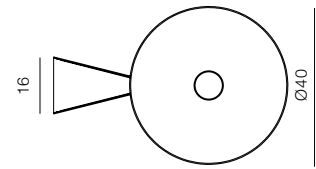
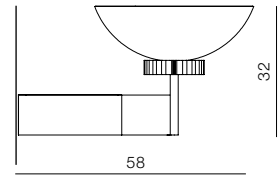
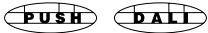





BRICK



Un estruso di alluminio a sezione rettangolare supporta moduli con luce LED orientabili. Disponibile nelle versioni da parete e da terra. Il sistema può soddisfare svariate esigenze d'illuminazione in contesti residenziali, commerciali e espositivi.

An extruded aluminium element with a rectangular section supports the adjustable LED light modules. Available for both wall and floor versions. The system easily meets different lighting needs in residential, commercial and exhibition contexts.





BRICK

parete / wall

Lampada da parete a luce diretta, orientabile.
Struttura e base girevole in alluminio verniciato.
Completo di alimentatore elettronico.
Sorgente di luce a LED, disponibile con tre diversi fasci di luce.

Wall adjustable lamp with adjustable direct light.
Adjustable painted aluminium structure and base.
Driver included in the body lamp.
LED light source, available with three different light beams.



watt	fascio/beam	flusso/flux	CCT	Kg	colore/colour	codice/code
27,5W 230V	narrow	3580lm	3000K	1,5	○ bianco/white	1396/S/L/1/O2/BI
	medium				○ bianco/white	1396/S/L/1/Q1/BI
	wide				○ bianco/white	1396/S/L/1/R/BI

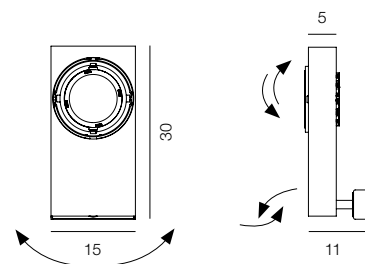

BRICK 1 SPOT - NARROW

BRICK 1 SPOT - MEDIUM

BRICK 1 SPOT - WIDE

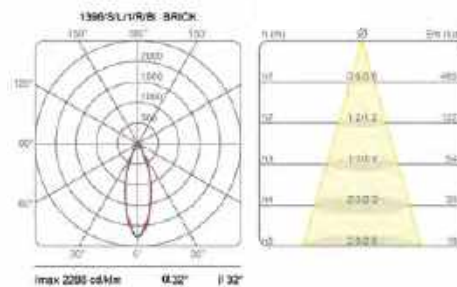
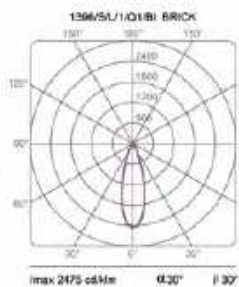
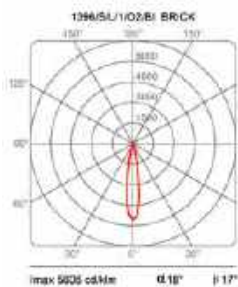

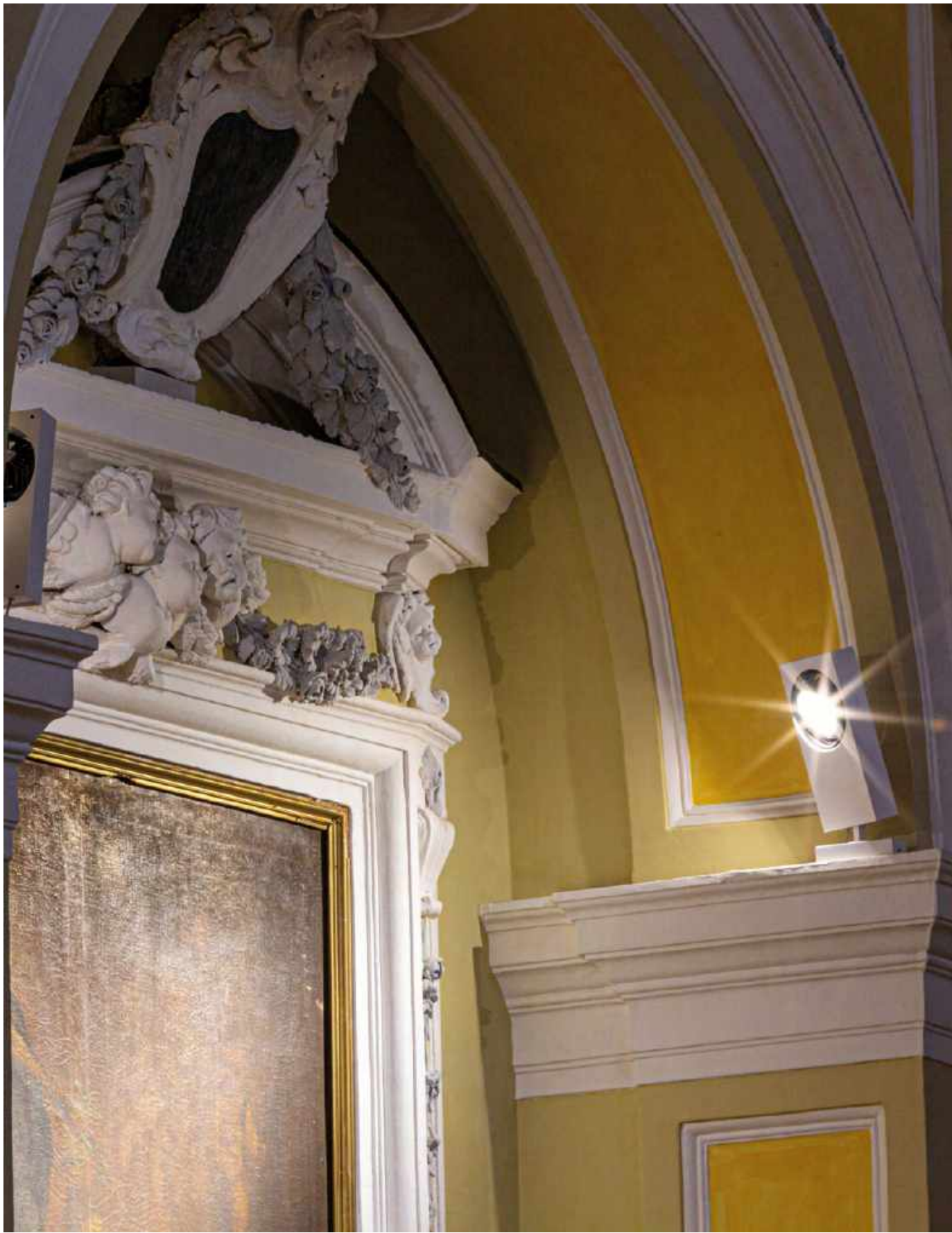

Chiesa di S. Giovanni Battista, Vietri sul mare, Salerno

BRICK

terra / standing

Apparecchio da terra girevole a luce diretta orientabile predisposto per 2 moduli LED integrati. Struttura in alluminio verniciato girevole sulla base. Alimentatore elettronico integrato nel corpo lampada. Sorgente di luce a LED, disponibile con diversi fasci di luce.

Swivel standing device with direct adjustable lights for two integrated LED light source modules. Painted aluminium structure, swivel on its base. Complete of electronic driver. LED light source, available with different light beams.



watt	fascio/beam	flusso/flux	CCT	Kg	colore/colour	codice/code
2x27,5W 230V	narrow	2x3580lm	3000K	1,5	○ bianco/white	2275/2/L/1/O2/BI
	medium				○ bianco/white	2275/2/L/1/Q1/BI
	wide				○ bianco/white	2275/2/L/1/R/BI

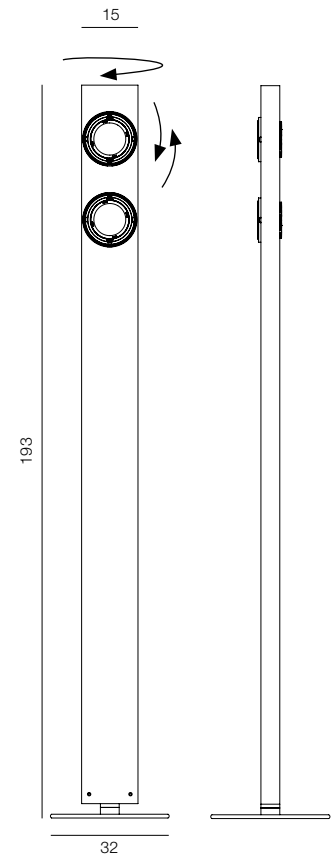

per diagrammi illuminotecnici vedi pagina precedente 416.
for lighting curve see the previous page 416.

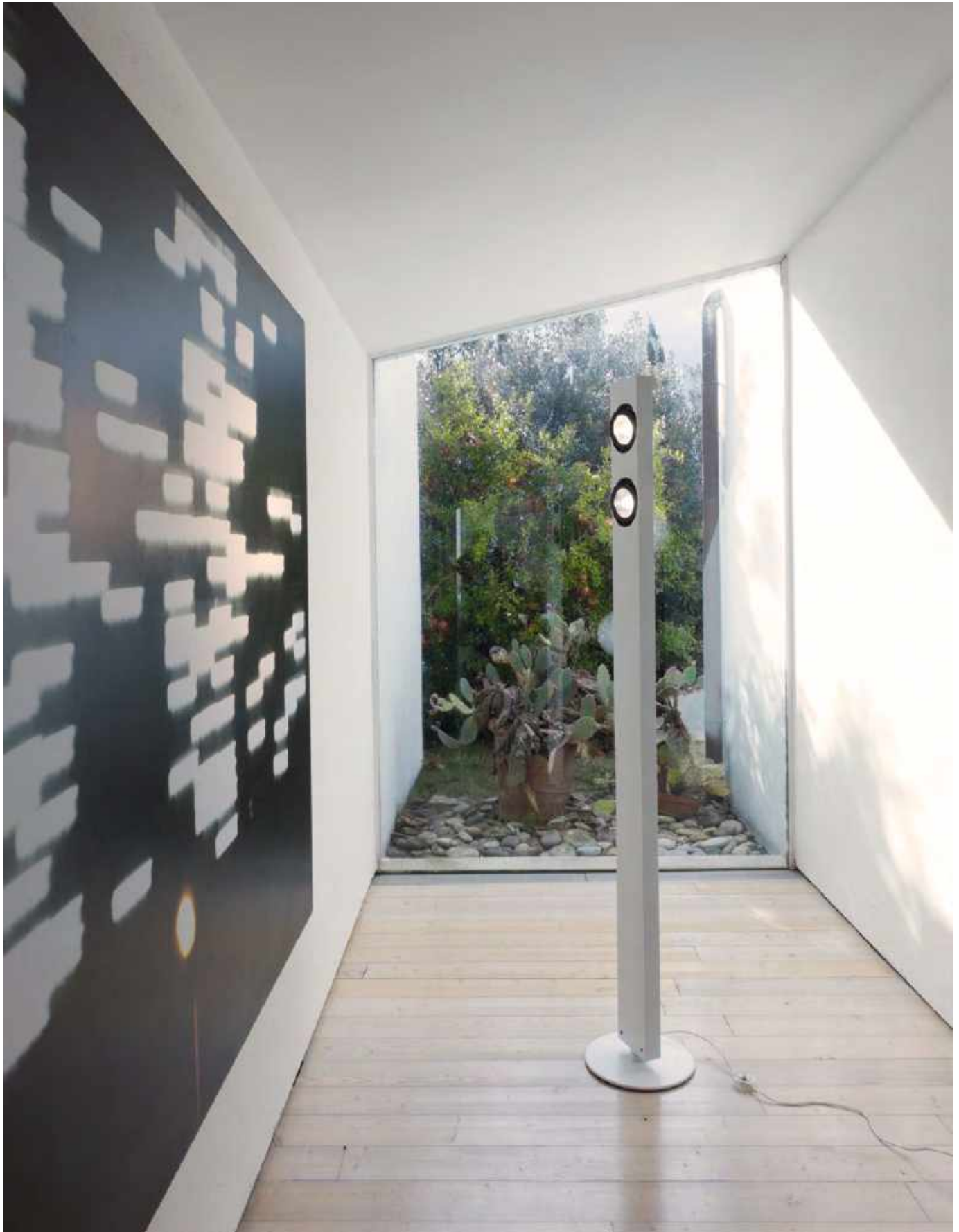



EYE



Una serie di apparecchi componibili per l'installazione a soffitto. Semplici cilindri nella versione singola, o uniti con moduli di collegamento di varie lunghezze per ottenere svariate configurazioni. Per sorgente di luce a LED orientabili per una luce d'accento, con due diversi fasci luminosi, per adattarsi alle diverse situazioni sia in spazi pubblici che residenziali.

A series of modular devices for ceiling installation. Simple cylinders in the single version, or joined with connection modules of various lengths in order to obtain different configurations. Adjustable LED light source with two light beam angles, adaptable to many different situations both in public and residential environments.

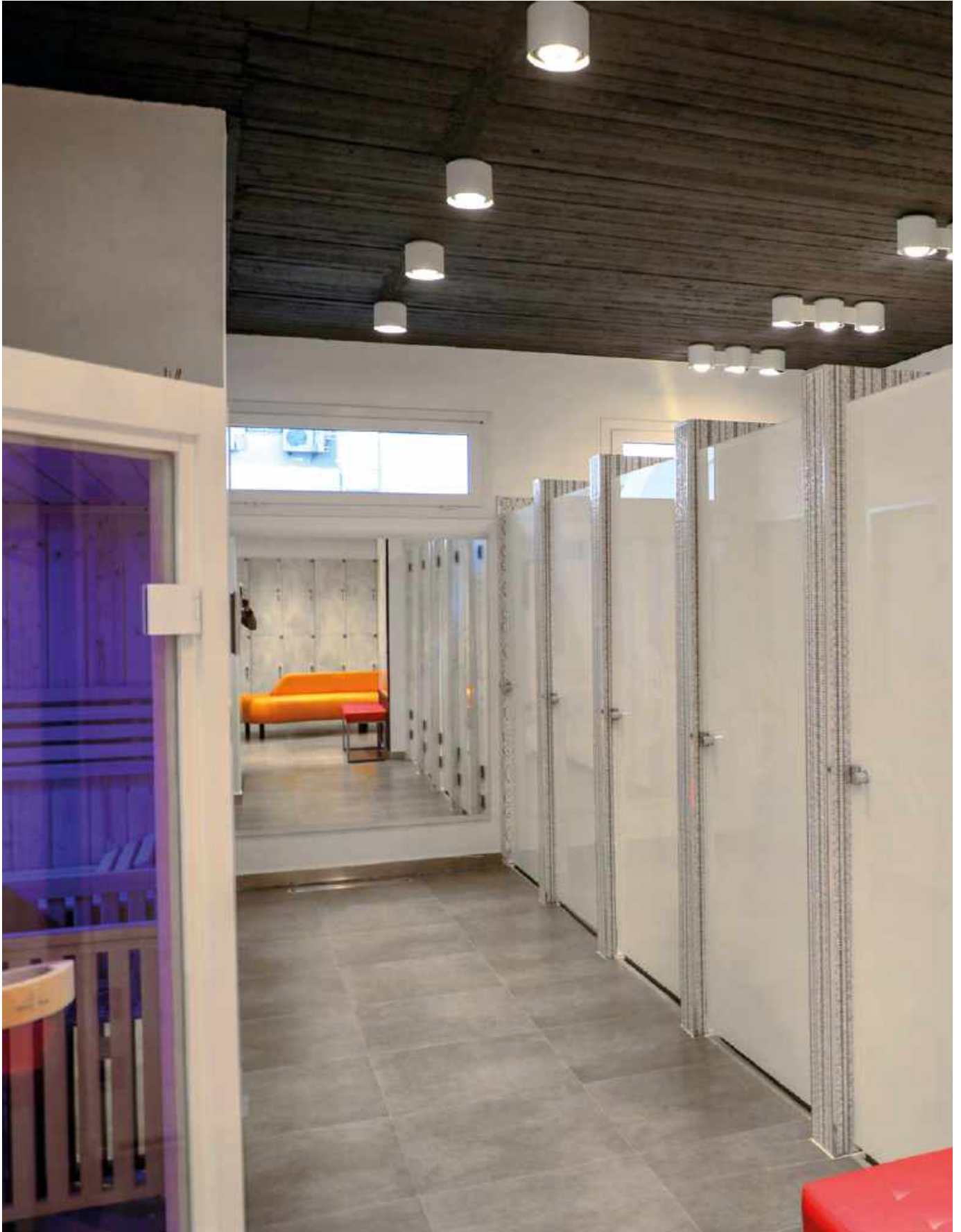

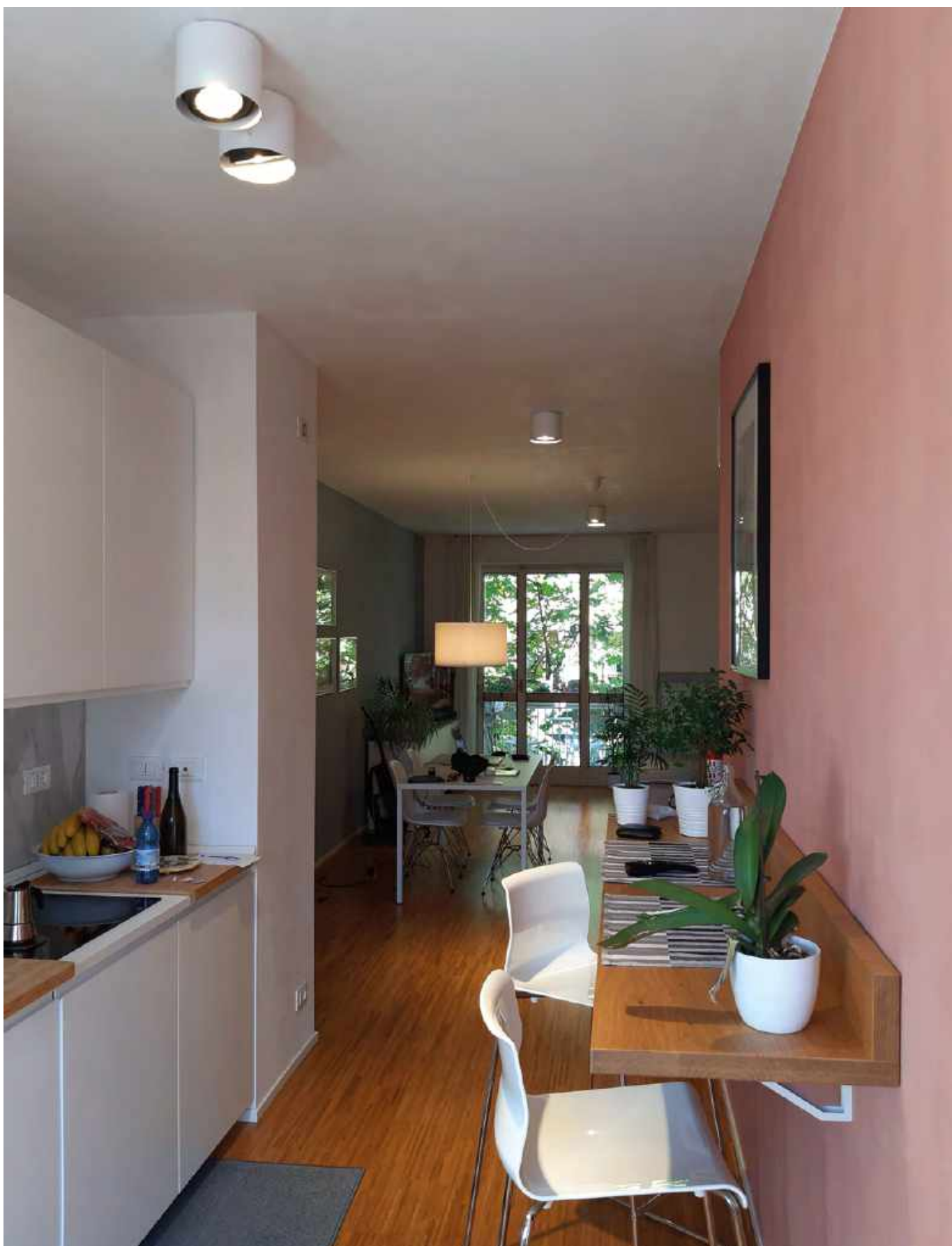







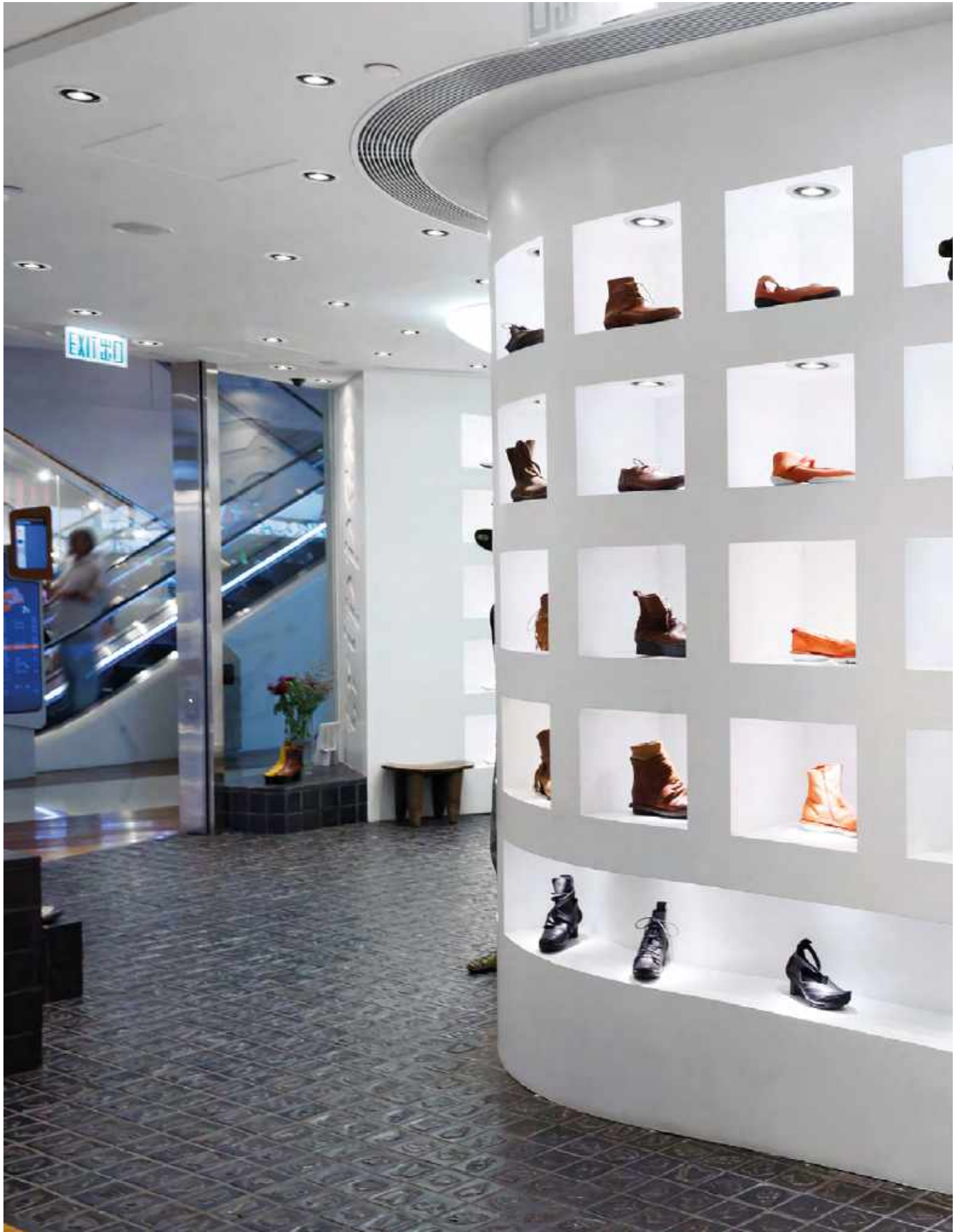

EYE

soffitto / ceiling

Apparecchio da soffitto componibile.
Sorgente a LED a luce diretta orientabile con diverse aperture del fascio luminoso. Composto da moduli cilindrici in alluminio verniciato e da giunti di connessione di varie lunghezze per il passaggio del cavo di alimentazione. Alimentatore elettronico integrato.

Modular ceiling lamp.
Adjustable and direct LED light source with different beam angles. Composed of a painted aluminium cylinder module and connection joints of various lengths for the passage of the power cable. Integrated electronic driver.



watt	fascio/beam	flusso/flux	CCT	Kg	colore/colour	codice/code
EYE modulo singolo / singular module						
17,3W 230V	narrow	2200lm	3000K	1	○ bianco/white	2876/1/L/1/14/BI
					● nero/black	2876/1/L/1/14/NE
	wide				○ bianco/white	2876/1/L/1/35/BI
					● nero/black	2876/1/L/1/35/NE
EYE predisposto per 1 giunto di collegamento / suitable for 1 connection joint						
17,3W 230V	narrow	2200lm	3000K	1	○ bianco/white	40148/14/BI
					● nero/black	40148/14/NE
	wide				○ bianco/white	40148/35/BI
					● nero/black	40148/35/NE
EYE predisposto per 2 giunti di collegamento / suitable for 2 connection joints (180°)						
17,3W 230V	narrow	2200lm	3000K	1	○ bianco/white	40149/14/BI
					● nero/black	40149/14/NE
	wide				○ bianco/white	40149/35/BI
					● nero/black	40149/35/NE
EYE predisposto per 2 giunti di collegamento / suitable for 2 connection joints (90°)						
17,3W 230V	narrow	2200lm	3000K	1	○ bianco/white	40152/14/BI
					● nero/black	40152/14/NE
	wide				○ bianco/white	40152/35/BI
					● nero/black	40152/35/NE
EYE predisposto per 3 giunti di collegamento / suitable for 3 connection joints (T)						
17,3W 230V	narrow	2200lm	3000K	1	○ bianco/white	40150/14/BI
					● nero/black	40150/14/NE
	wide				○ bianco/white	40150/35/BI
					● nero/black	40150/35/NE
EYE predisposto per 4 giunti di collegamento / suitable for 4 connection joints (cross)						
17,3W 230V	narrow	2200lm	3000K	1	○ bianco/white	40151/14/BI
					● nero/black	40151/14/NE
	wide				○ bianco/white	40151/35/BI
					● nero/black	40151/35/NE

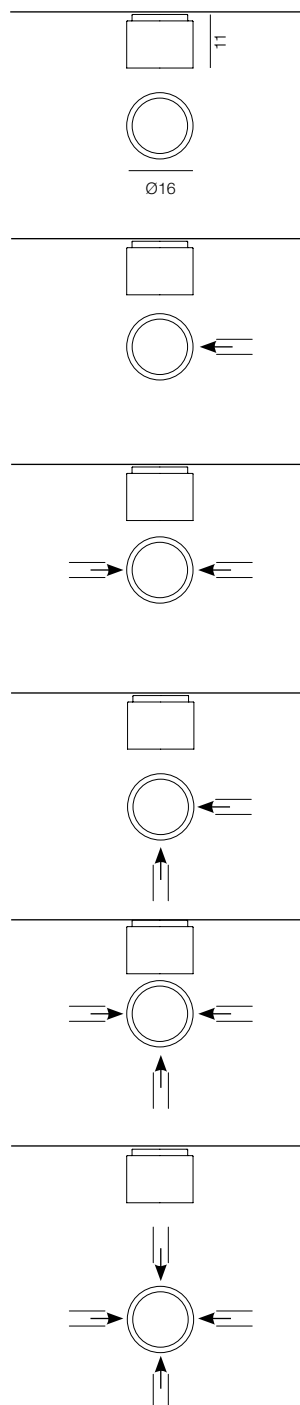

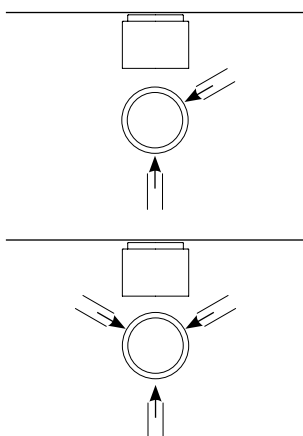

watt	fascio/beam	flusso/flux	CCT	Kg	colore/colour	codice/code
EYE predisposto per 2 giunti di collegamento / suitable for 2 connection joints (120°)						
17,3W	230V narrow	2200lm	3000K	1	○ bianco/white	40153/14/BI
					● nero/black	40153/14/NE
	wide				○ bianco/white	40153/35/BI
					● nero/black	40153/35/NE

EYE predisposto per 3 giunti di collegamento / suitable for 3 connection joints (120°)						
17,3W	230V narrow	2200lm	3000K	1	○ bianco/white	40154/14/BI
					● nero/black	40154/14/NE
	wide				○ bianco/white	40154/35/BI
					● nero/black	40154/35/NE

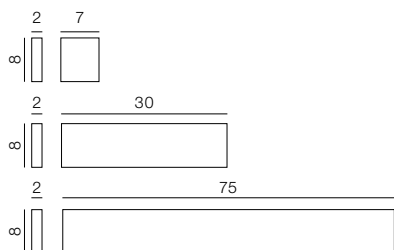

GIUNTI DI COLLEGAMENTO / CONNECTION JOINTS		
giunto / joint 7cm	○ bianco/white	40155/BI
	● nero/black	40155/NE
giunto / joint 30cm	○ bianco/white	40156/BI
	● nero/black	40156/NE
giunto / joint 75cm	○ bianco/white	40157/BI
	● nero/black	40157/NE

EYE 1 SPOT NARROW

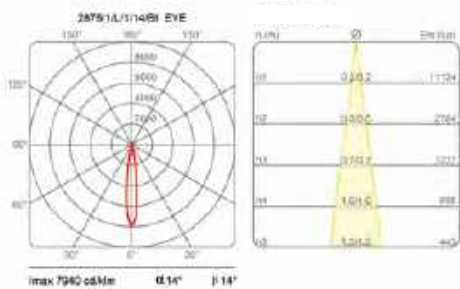

EYE 1 SPOT WIDE

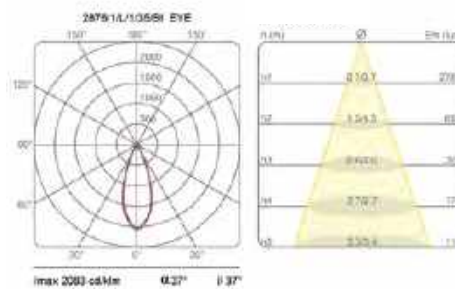

EYE

incasso / recessed



Apparecchio da incasso per sorgente di luce a LED orientabile, per una illuminazione d'accento efficace e versatile. Di facile installazione e buona integrazione nel controsoffitto.
Con diverse aperture del fascio luminoso.
Alimentatore remoto.

Recessed, adjustable light device. LED light source, for an effective and versatile accentuated lighting. Easy to fix, with a full integration in a false ceiling. With different light beam angles.
Remote driver.



watt	fascio/beam	flusso/flux	CCT	Kg	colore/colour	codice/code
27,5W 230V	narrow	3580lm	3000K	1	○ bianco/white	2882/L/1/O2/BI
	medium				○ bianco/white	2882/L/1/MS/BI
	wide				○ bianco/white	2882/L/1/R/BI

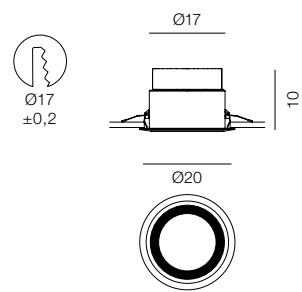

alimentatore elettronico incluso da inserire nel controsoffitto
electronic driver included to be placed inside the false ceiling

EYE 1 SPOT NARROW

EYE 1 SPOT MEDIUM

EYE 1 SPOT WIDE

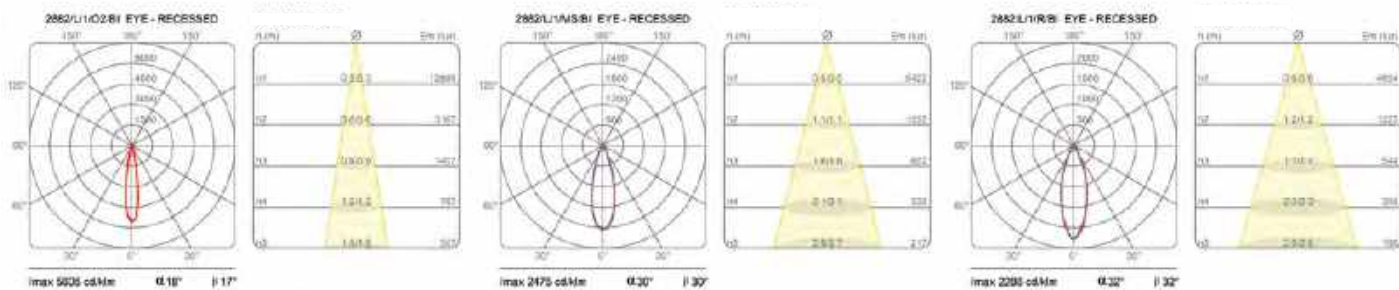



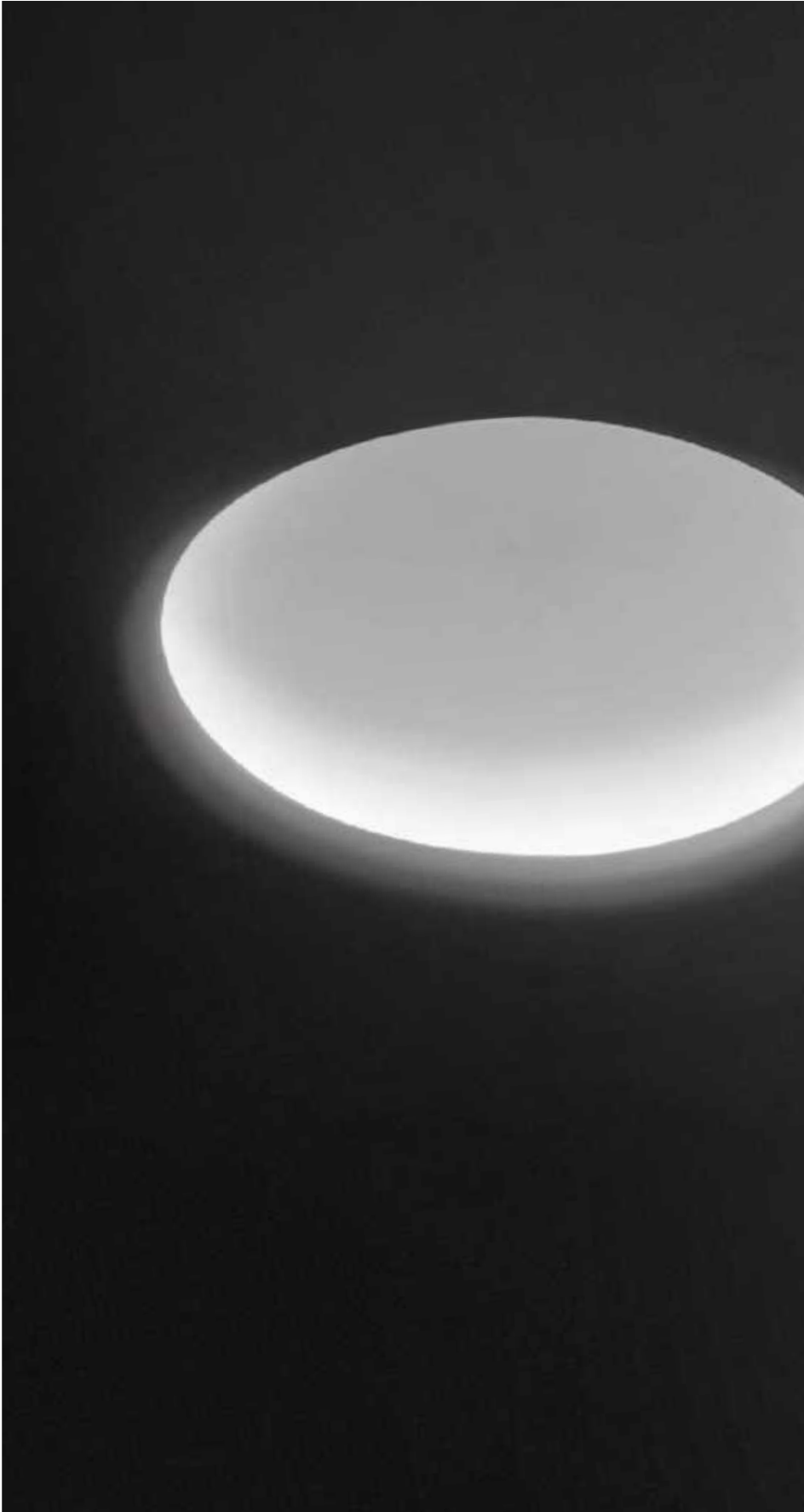

BIG



Un ampio foro da cui fuoriesce una luce morbida e diffusa.
Un apparecchio da incasso in cartongesso che garantisce la totale integrazione nello spazio architettonico.
Sorgente di luce LED integrata.

A large hole that transmits a soft and diffused light.
A recessed fixture to be fixed in plasterboard that guarantees the full integration in the architectural space.
Integrated LED light source.





BIG

Apparecchio da soffitto ad incasso a luce diffusa, integrato in un pannello di cartongesso (A). È formato da un anello in alluminio verniciato fissato a scomparsa sul pannello (C). Completo di sorgente di luce a LED e di una parabola alzabile per l'ispezione (P). Alimentatori elettronici da inserire nel controsoffitto.

Recessed ceiling device, diffused light, integrated in a plasterboard panel (A). The device is composed of a recessed painted aluminium ring (C). Complete of LED light source, and a liftable parabola for inspection (P). Electronic drivers included to be placed in the false ceiling.



watt	flusso/flux	CCT	Kg	colore/colour	codice/code
48W 230V/700mA	6000lm	3000K	9	○ bianco/white	2858/CG/DIM/L/1/BI

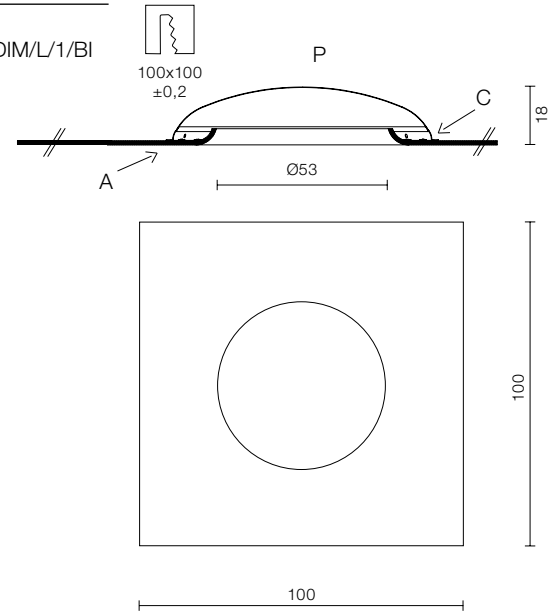

alimentatori elettronici dimmerabili da inserire nel controsoffitto
 electronic dimmable drivers integrated to be placed in the false ceiling.



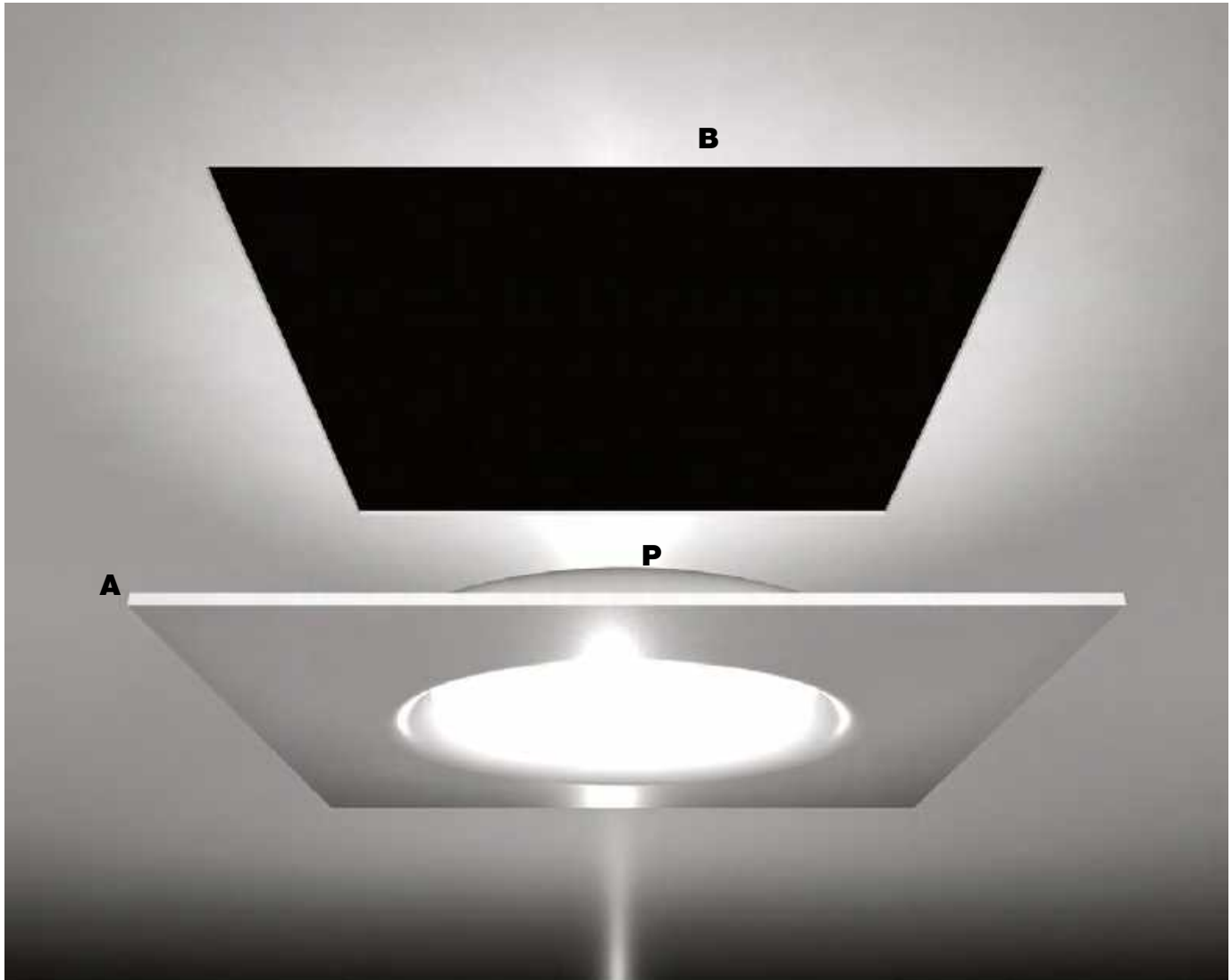

- A) pannello in cartongesso. cm 120 x 100
plasterboard panel counter
- B) controsoffitto in cartongesso.
plasterboard ceiling.
- P) parabola in alluminio removibile nel colore bianco
bianco per l'inserimento degli alimentatori
nel controsoffitto e per permettere la
manutenzione.
removable white lacquered aluminium
reflector for the insertion of the drivers in the
false-ceiling or to allow the maintenance.
- C) anello in alluminio verniciato nel colore bianco
completo di cablaggio e della sorgente di
luce LED fissato al pannello di cartongesso A.
white lacquered aluminium wiring ring
complete of LED light source fixed to the
panel of plasterboard A.

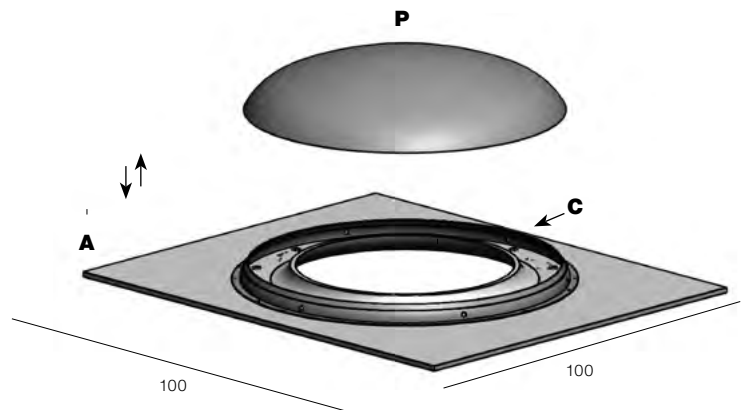



OBLÒ



Una lampada da incasso rotonda
a luce diffusa.

Un diffusore con foro in metacrilato
nasconde la sorgente di luce a
LED per ottenere un'illuminazione
confortevole nell'ambiente.

A round, recessed lamp with
diffused light.

A shade in methacrylate with
a hole that hides the LED light
source in order to obtain a
comfortable lighting on the
environment.

OBLÒ

Lampada da soffitto a incasso a luce diffusa.
Struttura in alluminio verniciato, diffusore in metacrilato opal bianco fissato a scatto sulla struttura di base.
Sorgente di luce a LED integrata.
Completo di alimentatori elettronici.

Recessed ceiling lamp with diffused light.
Painted aluminium structure with a white opal methacrylate snap-on-connected shade.
Integrated LED light source.
Electronic driver included.

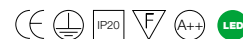

watt	flusso/flux	CCT	Kg	colore/colour	codice/code
28,4W 230V	3900lm	3000K	9	○ bianco/white	2859L/1

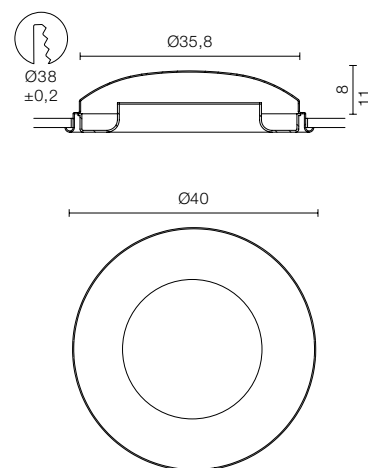





INC



Apparecchi da incasso singoli o composti con tre lampade.
Sorgente di luce a LED.
Una soluzione integrata nel soffitto per un'illuminazione d'accento diretta orientabile, che si presta a vari impieghi, residenziale, centri commerciali o negozi.

Single or triple recessed lighting fixtures.
LED light source.
An integrated ceiling solution for a direct, adjustable accent lighting that lends itself to different uses: residential areas, shopping centers as well as stores.

INC

Apparecchio da soffitto a incasso per interni a luce diretta orientabile.
 Struttura in metallo verniciato, particolari in resina. Disponibile come modulo singolo e modulo con tre sorgenti di luce a LED.
 Disponibile con diverse aperture del fascio luminoso.
 Alimentatore elettronico escluso, da inserire all'interno del controsoffitto.

Recessed wall lighting device for indoor with direct adjustable light.
 Painted metal structure, black resin details.
 Both single and triple LED light source module. Available with different light beam angles.
 Electronic driver not included, to be inserted inside the false ceiling.



watt	fascio/beam	flusso/flux	CCT	Kg	colore/colour	codice/code
------	-------------	-------------	-----	----	---------------	-------------

INC 1 SPOT

1x27,5W 800mA	narrow	1x3580lm	3000K	1	○ bianco/white	2860/1/L/1/O2/BI	
					● nero/black	2860/1/L/1/O2/NE	
	medium					○ bianco/white	2860/1/L/1/Q1/BI
						● nero/black	2860/1/L/1/Q1/NE
	wide					○ bianco/white	2860/1/L/1/R/BI
						● nero/black	2860/1/L/1/R/NE

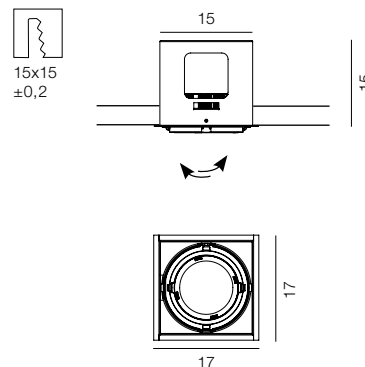

alimentatore elettronico remoto / remote electronic driver

1x28W 230V/800mA

5924

INC 3 SPOT

3x27,5W 800mA	narrow	3x3580lm	3000K	1	○ bianco/white	2860/3/L/1/O2/BI	
					● nero/black	2860/3/L/1/O2/NE	
	medium					○ bianco/white	2860/3/L/1/Q1/BI
						● nero/black	2860/3/L/1/Q1/NE
	wide					○ bianco/white	2860/3/L/1/R/BI
						● nero/black	2860/3/L/1/R/NE

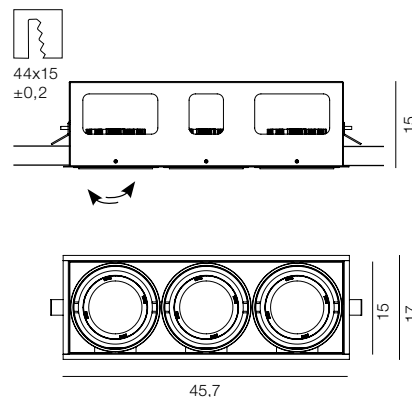

alimentatori elettronici remoti / remote electronic drivers

3x28W 230V/800mA

5924

INC 1 SPOT NARROW

INC 1 SPOT MEDIUM

INC 1 SPOT WIDE

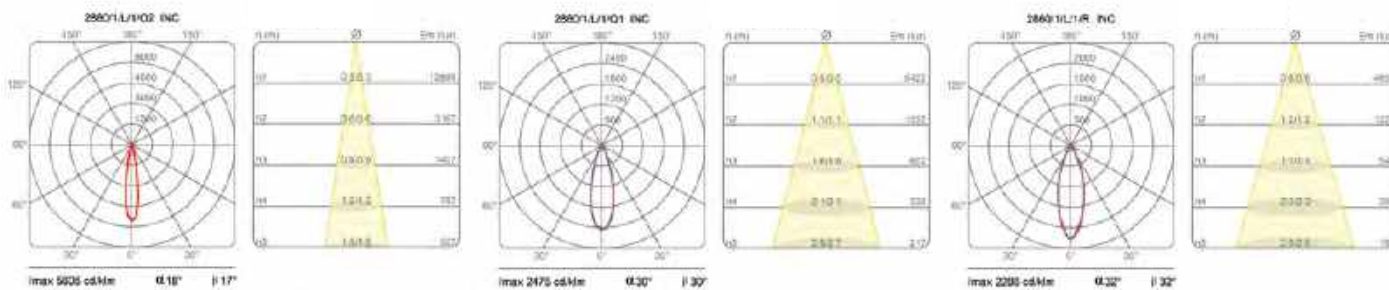



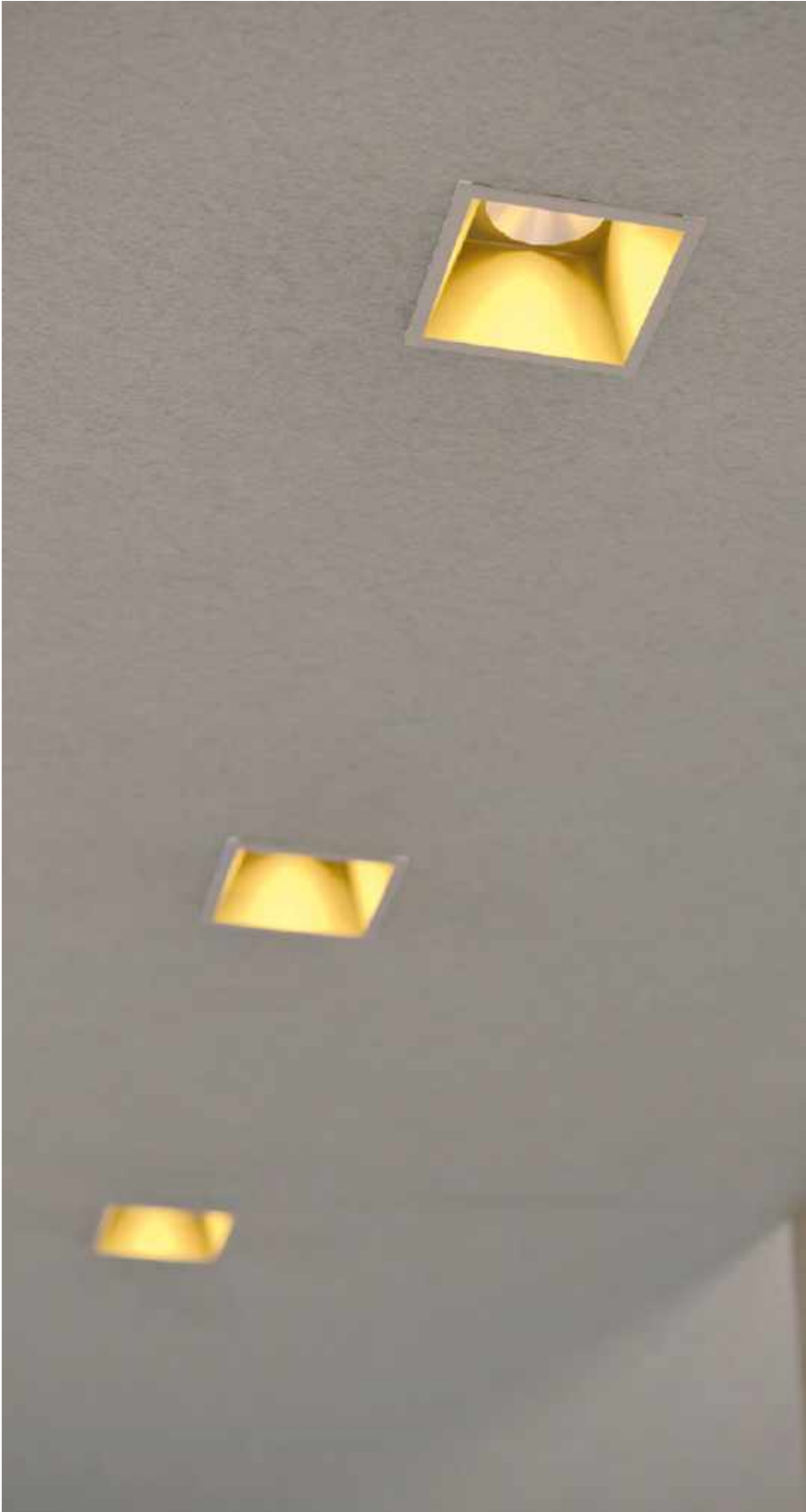

DOT



Una serie di faretti junior ad incasso per installazione a soffitto da interno. Piccoli punti di luce per un minimo impatto visivo. Disponibili in diverse varianti, per una luce d'accento.

A series of recessed junior spotlights for indoor ceiling mounting. Small points of light for minimal visual impact. Available in different variants, for an accent light.





DOT

Una serie di faretti ad incasso da interno orientabili per ottenere diversi effetti di luce d'accento. Disponibili nella versione rotonda, quadrata, orientabile e wall washer. Sorgente di luce a LED integrata. Alimentatore remoto incluso.

A series of adjustable indoor spotlights to obtain different accent lighting effects. Available in the round, square, adjustable and wall washer versions. Integrated LED light source. Remote driver included.



watt	fascio/beam	flusso/flux	CCT	Kg	colore/colour	codice/code
------	-------------	-------------	-----	----	---------------	-------------

DOT SQUARE

8W	medium	680lm	3000K	<input type="radio"/> bianco/white <input type="radio"/> nero/black <input type="radio"/> rosso/red <input type="radio"/> oro p./p. gold	2892/BI/BI 2892/BI/NE 2892/BI/RO 2892/BI/AU
----	--------	-------	-------	---	--

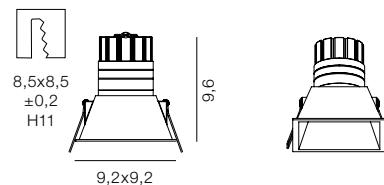

DOT WALL WASHER

8W	medium	680lm	3000K	<input type="radio"/> bianco/white <input type="radio"/> nero/black <input type="radio"/> rosso/red <input type="radio"/> oro p./p. gold	2893/BI/BI 2893/BI/NE 2893/BI/RO 2893/BI/AU
----	--------	-------	-------	---	--

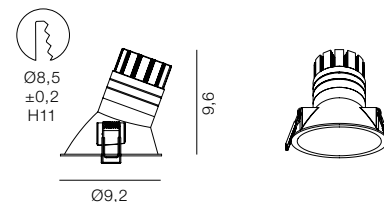

DOT ROUND

8W	medium	680lm	3000K	<input type="radio"/> bianco/white <input type="radio"/> nero/black <input type="radio"/> rosso/red <input type="radio"/> oro p./p. gold	2894/BI/BI 2894/BI/NE 2894/BI/RO 2894/BI/AU
----	--------	-------	-------	---	--

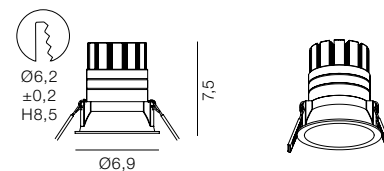

DOT DEEP

8W	medium	680lm	3000K	<input type="radio"/> bianco/white <input type="radio"/> nero/black <input type="radio"/> rosso/red <input type="radio"/> oro p./p. gold	2895/BI/BI 2895/BI/NE 2895/BI/RO 2895/BI/AU
----	--------	-------	-------	---	--

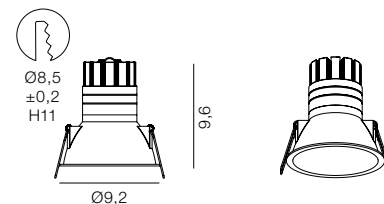

alimentatore remoto incluso / remote driver included.

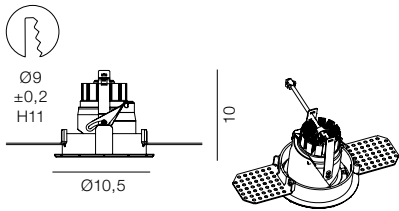

watt	fascio/beam	flusso/flux	CCT	Kg	colore/colour	codice/code
------	-------------	-------------	-----	----	---------------	-------------

DOT SPIN

9W	wide	680lm	3000K		○ bianco/white	2896/BI
----	------	-------	-------	--	----------------	---------

IP 65 vano esterno – IP 20 vano interno

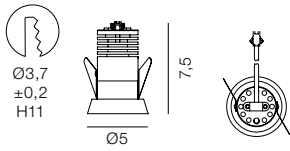

DOT BRIGHT

5W	medium	680lm	3000K		● rame/copper	2897/CU
----	--------	-------	-------	--	---------------	---------

	● cromo/chrome	2897/CR
--	----------------	---------

IP 44

DOT SQUARE



DOT WALL WASHER



DOT ROUND



DOT DEEP



DOT SPIN



DOT BRIGHT



alimentatore remoto incluso / remote driver included.



Martinelli Luce presenta una serie di lampade per esterno frutto di una ricerca di diverse soluzioni per illuminare gli spazi aperti.

Lampade pensate per valorizzare con la luce particolari angoli del giardino o del terrazzo, illuminare percorsi, esaltare cespugli o alberi ma anche gli elementi architettonici, in modo discreto ed a volte giocoso.

Lampade nate sia dallo studio di progettazione interno all'azienda, sia dalla collaborazione con designer esterni in base a una ricerca funzionale, tecnologica ed estetica e con un design che identifica il nostro marchio da molto tempo.

Martinelli Luce presents a series of lamps for outdoors, the result of research into different solutions for lighting open spaces.

Lamps designed to enhance with light particular corners of the garden or terrace, illuminate paths, enhance bushes or trees but also architectural elements, in a discreet and sometimes playful way.

Lamps created both by the company's in-house design studio and in collaboration with external designers on the basis of functional, technological and aesthetic research and with a design that has long identified our brand.

outdoor

FROG
BRUCO
BOLETO
CYBORG
PONT
SISTEMA OUT
SISTEMA POLO
KOALA
PLAN
KIKI
CIULIFRULI
TRILLY
PISTILLO
BICONICA POL
GLOUGLOU POL
BOWL
2250



FROG



Una luce d'accento, orientabile, mobile per outdoor. La puoi semplicemente appoggiare a terra e illuminare con i suoi diversi fasci di luce una siepe, un grande albero, un angolo del tuo giardino e anche una scultura. Ma puoi fissarlo anche con un picchetto a terra. Frog è utile, funzionale, divertente.

An adjustable, movable, accent light for outdoor use. You can simply place it on the ground and illuminate with its various beams of light, a hedge, a large tree, a corner of your garden and even a sculpture. But you can also fix it with a peg on the ground. Frog is useful, functional, fun.





Residenza Il Palazzaccio, Lucca

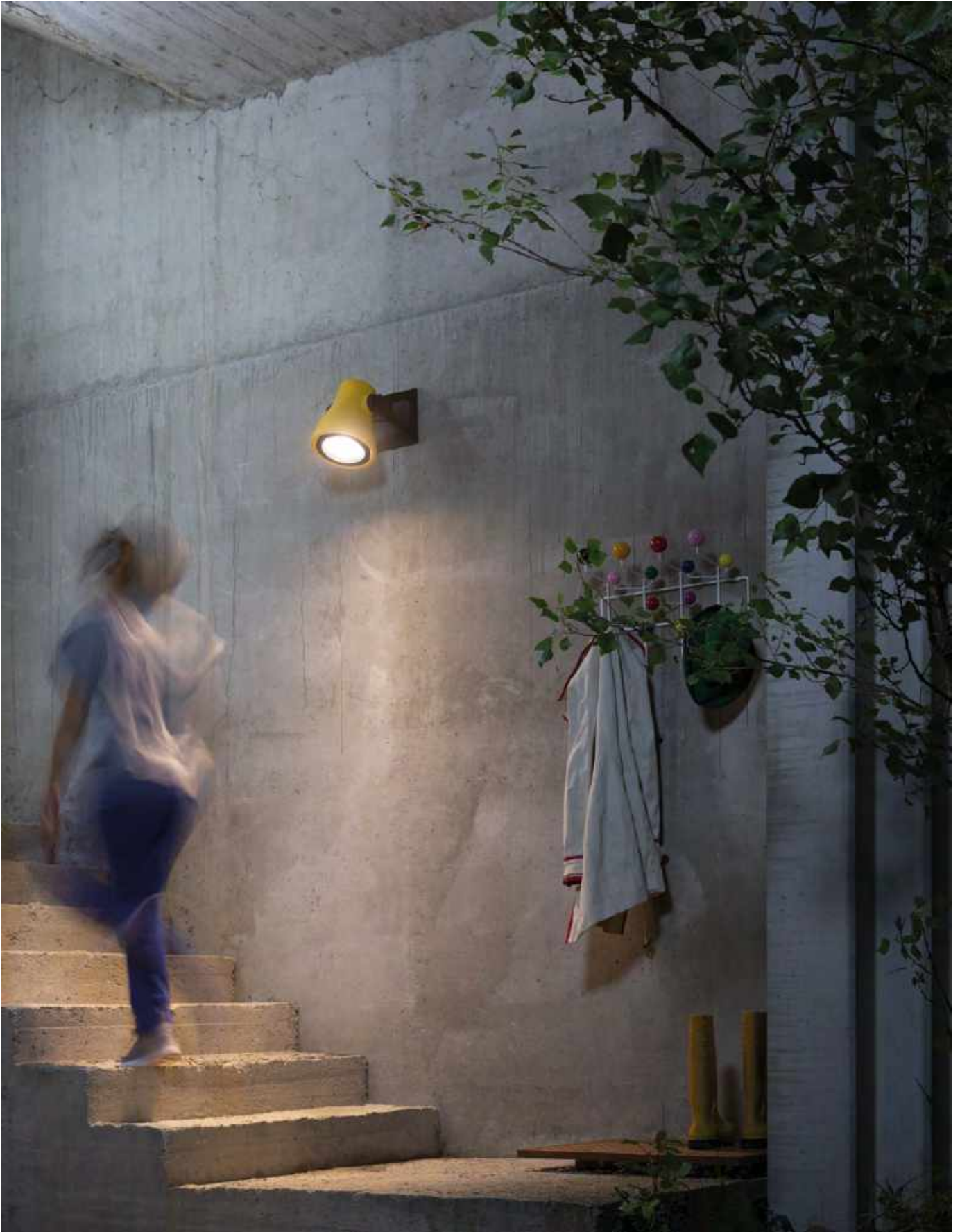



FROG

terra / ground

Lampada da esterno a luce diretta orientabile. Da spostare liberamente grazie alla base di appoggio in alluminio verniciato nel colore nero. Corpo lampada stampato con tecnologia rotazionale in polietilene nei colori: blu ottanio, giallo e nero. Per lampadina a LED. Disponibile picchetto per fissare la lampada nel prato.

Outdoor lamp with adjustable direct light. With black painted aluminium base. Body lamp moulded in polyethylene with rotational technology in octane blue, yellow or black colour. For LED bulb. A peg is available to fix the lamp in the lawn.



IP65

watt fascio/beam flusso/flux CCT Kg colore/colour codice/code

FROG con base di appoggio / with base

20W E27 PAR38 230V 45°	1910lm	3000K	2	● blu/blue	2309/BL
				● giallo/yellow	2309/GI
				● antracite/anthracite	2309/AN

cavo di alimentazione e spina / power cable and plug 5m

picchetto per fissaggio a terra / peg for ground fixing (optional) 40166

LAMPADINE / BULBS

14W E27 PAR38 230V 25°	1400lm	3000K			509X
20W E27 PAR38 230V 45°	1910lm	3000K			510X
14W E27 PAR38 230V 75°	1400lm	3000K			511X

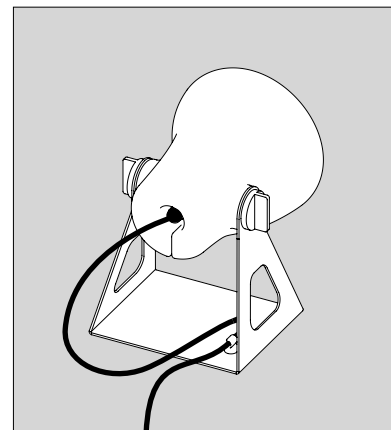
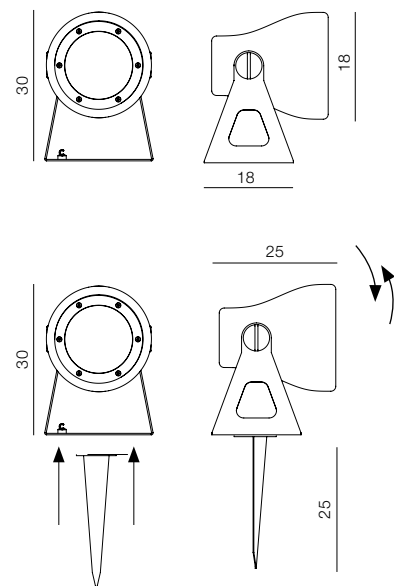

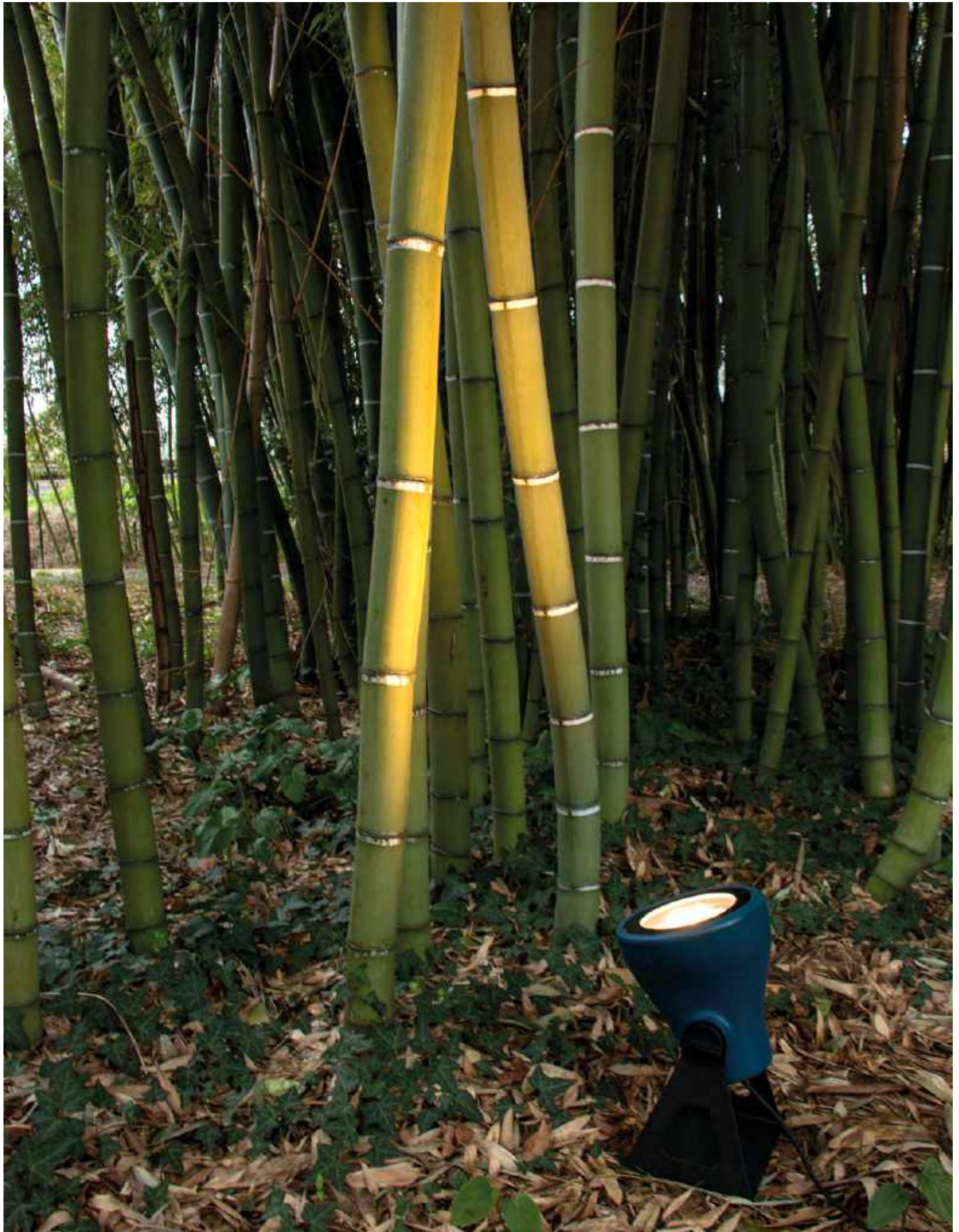

FROG



parete / wall

Lampada da esterno a luce diretta orientabile. Con base di appoggio da fissare a parete in alluminio verniciato nel colore nero. Corpo lampada stampato con tecnologia rotazionale in polietilene nei colori: blu ottanio, giallo e nero. Per lampadina a LED.

Outdoor lamp with adjustable direct light. With black painted aluminium base to be fixed to the wall. Body lamp moulded in polyethylene with rotational technology. Available in: octane blue, yellow or black colour. For LED bulb.



IP65

watt	fascio/beam	flusso/flux	CCT	Kg	colore/colour	codice/code
20W E27 PAR38 230V	45°	1910lm	3000K	2	 blu/blue	1453/BL
					 giallo/yellow	1453/GI
					 antracite/anthracite	1453/AN

LAMPADINE / BULBS

14W E27 PAR38 230V	25°	1400lm	3000K		509X
20W E27 PAR38 230V	45°	1910lm	3000K		510X
14W E27 PAR38 230V	75°	1400lm	3000K		511X

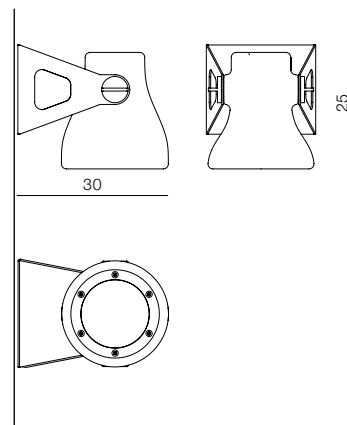





BRUCO



Una famiglia di lampade componibili a luce diretta per esterno, da fissare a terra o a parete.

Una testa con sorgente di luce LED sovrapponibile, con diverse posizioni di orientamento, fissata a un palo di varie altezze compongono, secondo le tue necessità, il Bruco.

A family of modular lamps with direct light for outdoor to be fixed to the ground or to the wall.

A pole of different heights of your choice, with a head composed of an overlapping LED light source, that you can fix with a different orientation, according to your needs.









Villa Bernardini, Vicopelago, Lucca





BRUCO

terra / ground

Lampada da esterno componibile a luce diretta. Struttura in pressofusione di alluminio verniciato nel colore antracite o corten, con palo da fissare a terra.

La lampada è componibile con gli elementi a lato (A,B,C,D,E), e da 1 a max 4 corpi lampada. Sorgente di luce LED integrata 230V.

Ogni corpo lampada (A) può essere fissato al palo (E) con composizione unidirezionale o con 4 possibili posizioni a 90°.

Outdoor modular lamp, with direct light. Anthracite or corten die-cast painted aluminium structure, with a pole to be fixed on the floor. The device can be composed with the elements on the side (A,B,C,D,E), up to 4 lamp bodies. Integrated 230V LED light source. Each element (A) can be fixed to the pole (E) with unidirectional composition or with four possible 90° positions.

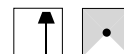

IP65

watt flusso/flux CCT dimensioni/size Kg colore/colour codice/code

(A) corpo lampada / body lamp

8W 230V 890lm 2700K Ø6,5 H 13,5 →14 1 ● antracite/anthracite 40059/AN
 ● corten/corten 40059/CO

(B) tappo / top Ø 6,5 H 1 0,1 ● antracite/anthracite 40060/AN
 ● corten/corten 40060/CO

(C) base / base Ø 13 H 3 0,6 ● antracite/anthracite 40061/AN
 ● corten/corten 40061/CO

(D) giunto / joint Ø 6,5 H 0,5 0,2 ● antracite/anthracite 40062/AN
 ● corten/corten 40062/CO

(E) palo / pole Ø 6,5 H 33 1 ● antracite/anthracite 40063/AN
 ● corten/corten 40063/CO

(E) palo / pole Ø 6,5 H 47 1,3 ● antracite/anthracite 40064/AN
 ● corten/corten 40064/CO

su richiesta disponibile con LED 12W / on request available with 12W LED

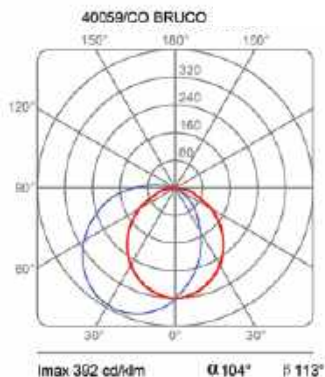
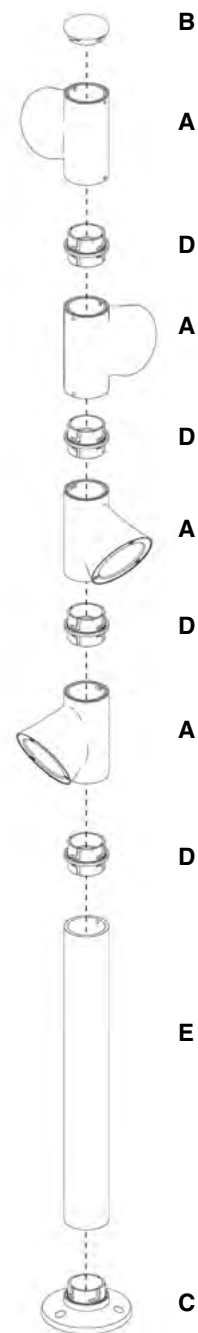



ESEMPI DI COMPOSIZIONE / EXAMPLES OF COMPOSITION

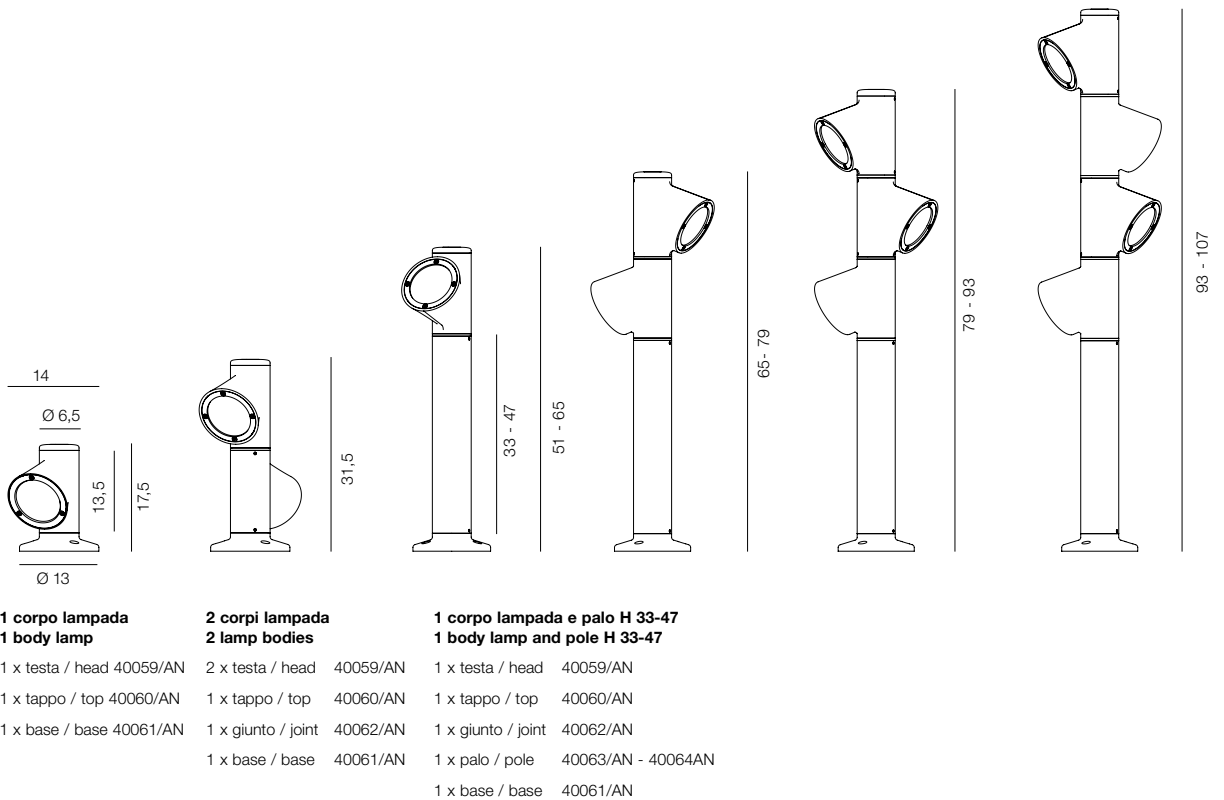

BRUCO

parete / wall

Lampada da parete della famiglia Bruco per esterno, a luce diretta/indiretta. Struttura in pressofusione di alluminio verniciata nei colori antracite o corten. Disponibile a uno o a due corpi lampada da assemblare con diverso orientamento a 90°. Sorgente di luce a LED integrata 230V.

Outdoor Bruco family wall lamp, direct/indirect light. Structure in aluminium die casting painted in anthracite or corten colours. Available with one or two lamp bodies to be assembled with different 90° orientation. Integrated LED light source 230V.



IP65

watt	flusso/flux	CCT	Kg	colore/colour	codice/code
------	-------------	-----	----	---------------	-------------

1 CORPO LAMPADA / BODY LAMP

8W 230V	890lm	2700K	1,5	● antracite/anthracite	1440/AN
				● corten/corten	1440/CO

2 CORPI LAMPADA / BODIES LAMP

2x8W 230V	2x890lm	2700K	2,5	● antracite/anthracite	1440/2/AN
				● corten/corten	1440/2/CO

su richiesta disponibile con LED 12W / on request available with 12W LED

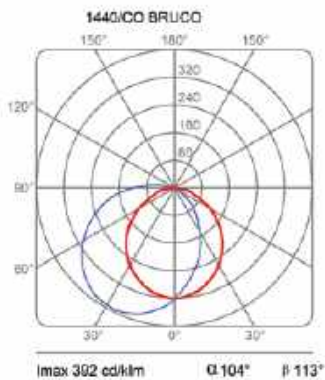
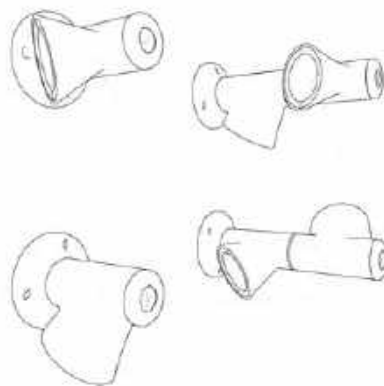
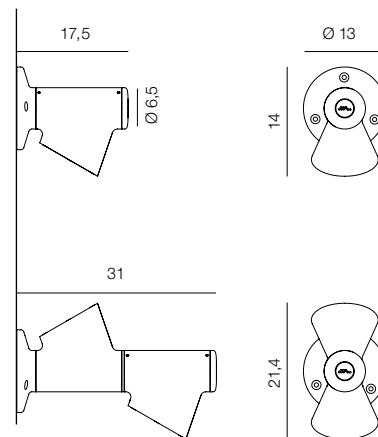

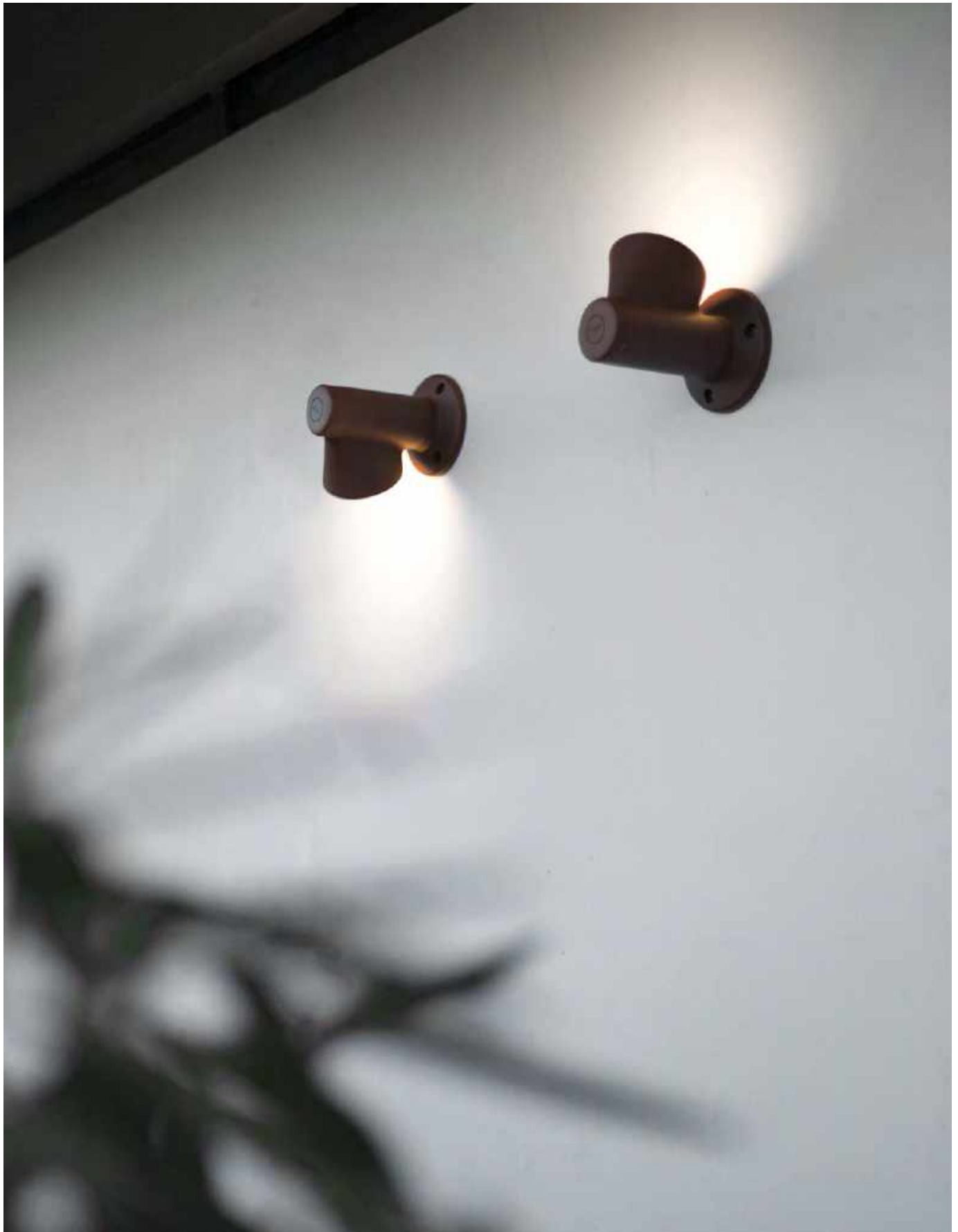



BOLETO



Esili strutture che spuntano dal prato. Il colore corten come la cappella del omonimo fungo. La luce indiretta illumina in modo non invadente un percorso, gli angoli e i cespugli nel giardino.

Slender structures springing up from your garden. Corten in colour, like the cap of the homonymous mushroom. The light with indirect illuminates a pathway, the corners and bushes of your garden.





BOLETO

Lampada da esterno a luce indiretta per sorgente di luce a LED. Struttura in alluminio verniciato nel colore corten. Stelo in tre altezze con base per il fissaggio a terra. Si consiglia l'installazione con fissaggio su un piccolo plinto di cemento o su una superficie piana. Disponibile anche un fissaggio con picchetto. Su richiesta a 24V con alimentatore remoto.

Outdoor lamp with indirect light for LED light source. Corten painted aluminium structure. Stem in three heights with base to be fixed on the ground. We recommend to install the lamp fixing on a plint of concrete or on a flat surface. Also available in the version with peg. On request 24V with remote driver.



IP65

watt	flusso/flux	CCT	Kg	colore/colour	codice/code
BOLETO H35					
10W 230V	1000lm	2700K	3,4	● corten/corten	2308/230/J/CO
BOLETO H50					
10W 230V	1000lm	2700K	3,5	● corten/corten	2308/230/CO
BOLETO H70					
10W 230V	1000lm	2700K	3,6	● corten/corten	2308/230/70/CO

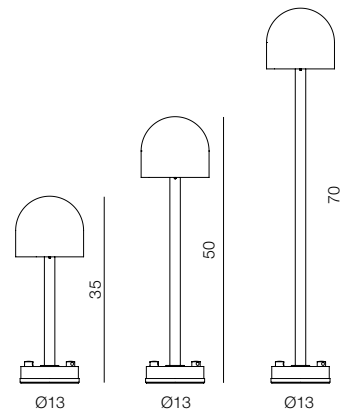

picchetto per fissaggio a terra / peg for ground fixing (optional) 40166

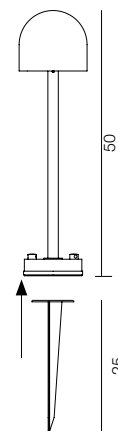

Su richiesta a 24V con alimentatore remoto / On request 24V with remote driver

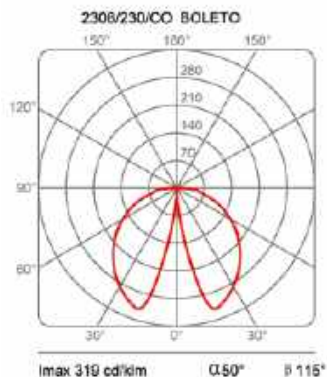

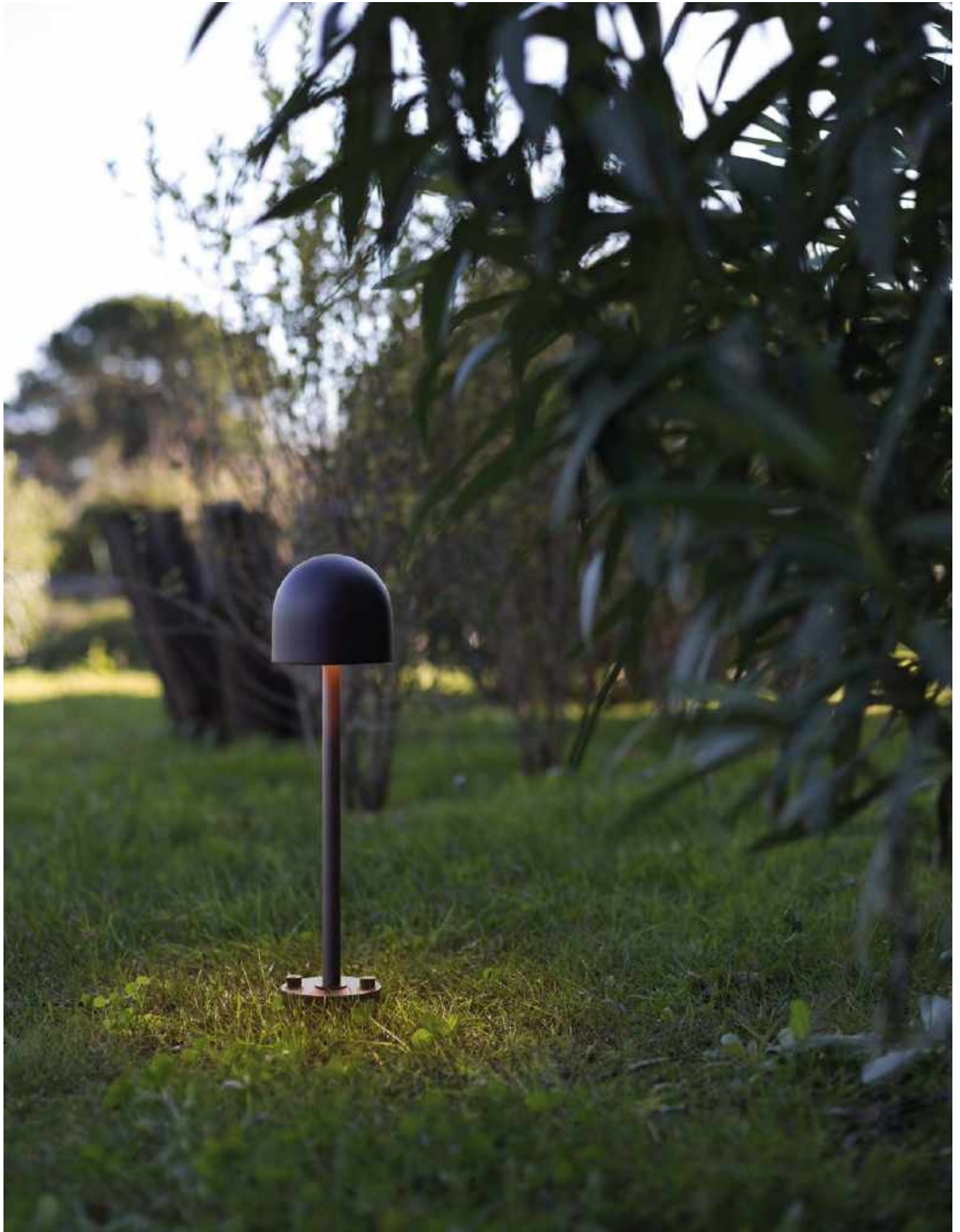



CYBORG outdoor

BIG SEE
PRODUCT DESIGN
AWARD 2020



Una lampada da esterno a luce indiretta per sorgente di luce a LED. Una forma insolita con struttura stampata in cemento ad alta resistenza. Cyborg può essere fissato a terra con picchetti nel giardino o semplicemente appoggiato sul pavimento di casa o del terrazzo.

An outdoor lamp with indirect light for LED light source. An unusual shape with a high resistance moulded concrete structure. Cyborg can be fixed to the ground with pegs in the garden or simply placed on the floor of the house or terrace.

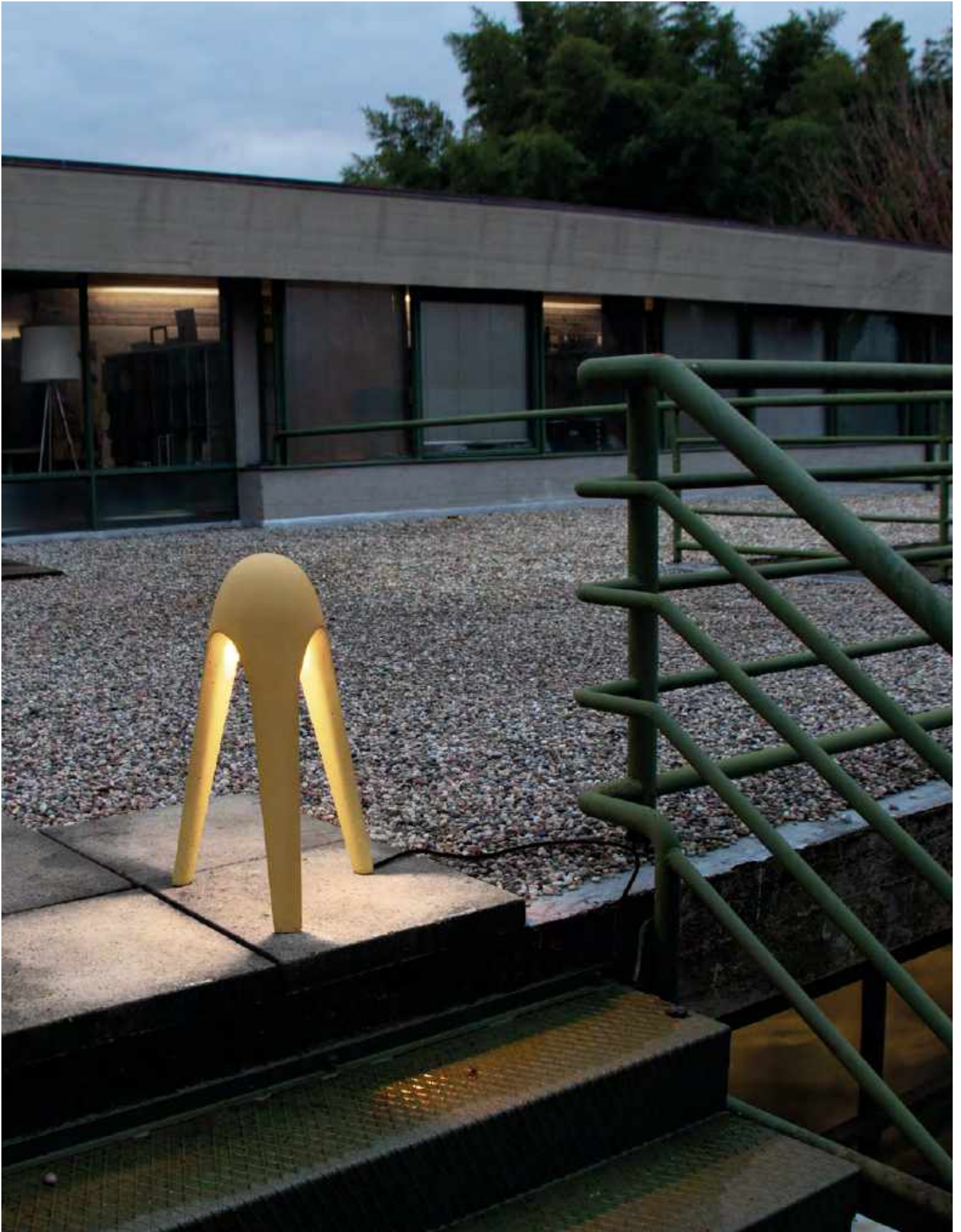

Sede Martinelli Luce, Lucca

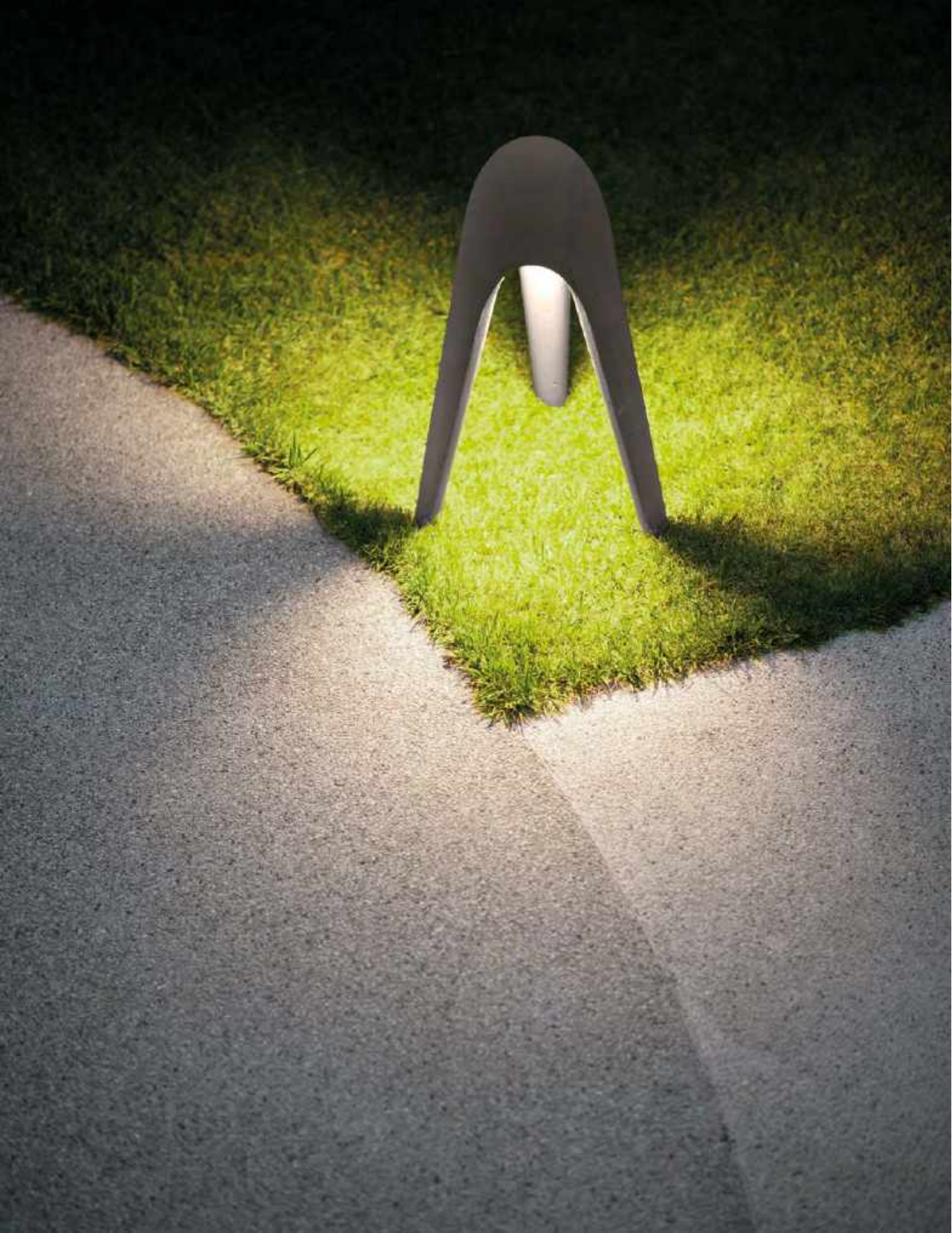

Il Diavoletto, S. Gennaro, Lucca - arch. Michel Boucquillon

CYBORG



Lampada da esterno a luce indiretta con cavo elettrico e spina, da appoggiare o da fissare a terra con picchetti.

Struttura stampata in cemento ad alta resistenza con idrorepellente, realizzato individualmente, con un processo artigianale. Disponibile nel colore grigio o giallo ocra. Per sorgente di luce a LED.

Outdoor lamp with indirect light to be placed on the ground with electric cable and plug or it can be fixed to the ground by using pegs.

High resistance concrete structure, made waterproof with a handcrafted process. Available in grey or yellow-ochre colours. For LED light source.



IP65

watt	flusso/flux	CCT	Kg	colore/colour	codice/code
10W 230V	1000lm	2700K	13	● grigio cemento/concrete grey	2306/GR
				● giallo ocra/yellow ochre	2306/GI

cavo di alimentazione nero e spina / black power cable and plug 5m

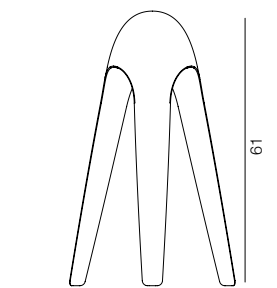

Ø40

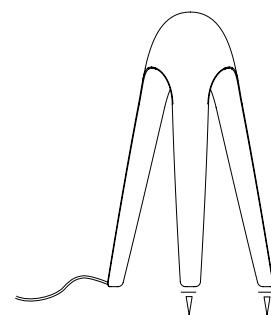
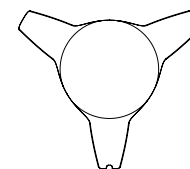

picchetti per il fissaggio a terra
pegs for ground fixing

0,5

40111

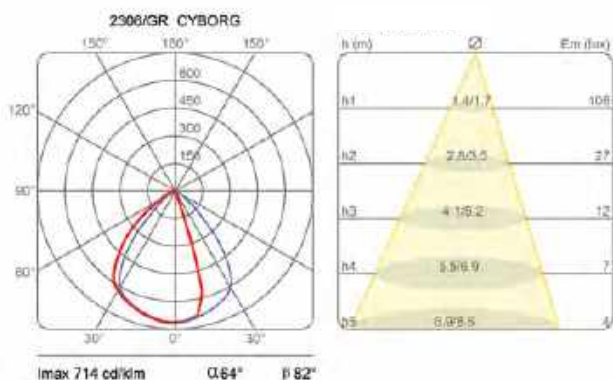





PONT



Una lampada per esterno dalla struttura stampata in cemento per sorgente di luce a LED, da fissare a terra nel prato.

Un ponte sottile come una lama, che illumina con luce indiretta il tuo giardino o delimita con la sua presenza un percorso.

An outdoor lamp with a concrete moulded structure for LED light source, to be fixed to the ground in the lawn.

A bridge as thin as a blade, which illuminates your garden with indirect light or delimits a path with its presence.





PONT



Una lampada da esterno, a luce indiretta, per illuminare il tuo spazio verde.

Da fissare a terra con basette in acciaio inox in dotazione, o da fissare al terreno con picchetti (optional) da bloccare all'estremità della lampada. Struttura in cemento ad alta resistenza con idrorepellente con un processo artigianale, nel colore grigio cemento, altri colori su richiesta.

Per sorgente di luce a LED. Alimentatore remoto (escluso).

An indirect-light outdoor lamp to illuminate your green spaces.

To be fixed to the ground with stainless steel base elements (provided), or with pegs (optional) to be fixed at the extremity of the lamp.

Waterproof high-resistance concrete structure, in grey colour, other colours on request.

For LED light source.
Remote driver (escluded).

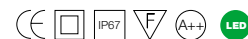

IP67

watt	flusso/flux	CCT	Kg	colore/colour	codice/code
24W 24V	1620lm	2700K	6,5	● grigio cemento concrete grey	40105/GR

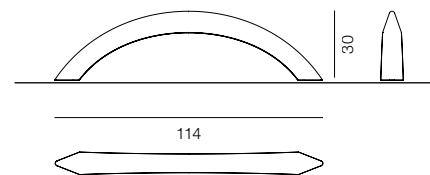

alimentatore remoto / remote driver IP67

30W 230/24V	1	40106
150W 230/24V	2	40107

scatola con alimentatore / box with driver IP67

30W 230/24V 20x20x20cm	2	40108
150W 230/24V 24x24x21cm	3	40109

kit 2 picchetti per il fissaggio a terra kit 2 pegs for ground fixing	0,6	40110
--	-----	-------

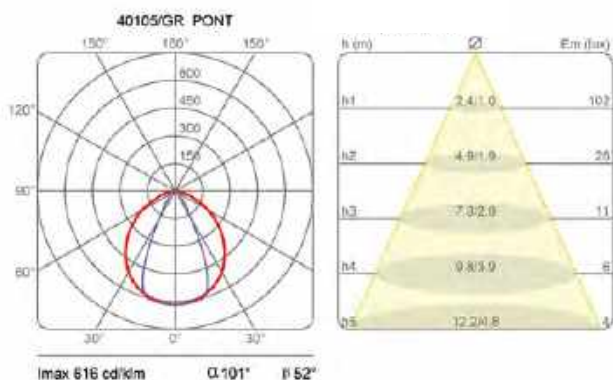





SISTEMA OUT



Una famiglia di lampade da esterno a luce diffusa con testa orientabile per sorgente di luce a LED. Nella versione da fissare terra con palo in vetroresina di diverse altezze e da parete con supporto girevole per direzionare la luce secondo le necessità.

An outdoor family of lamps with diffused light, with adjustable head for LED light source. In the version with fiberglass pole of different heights, to be fixed on the ground and the wall version with adjustable support to direct the light as needed.

OUT





Antico Caffè delle Mura, Lucca

OUT

terra / ground

Lampada da terra a luce diffusa su palo.
Corpo orientabile in resina rinforzata con fibra di vetro, diffusore in policarbonato, griglia in acciaio inox, palo in vetroresina.
Verniciato con vernici poliuretaniche nel colore bianco, antracite o corten.
Sorgente di luce a LED integrata.

Outdoor standing lamp with diffused light.
Adjustable resin body lamp reinforced with glass fibers, polycarbonate diffuser, stainless steel grid, fiberglass rod. White, anthracite or corten polyurethane paints structure.
Integrated LED light source.



IP65

watt	flusso/flux	CCT	Kg	colore/colour	codice/code
OUT H42					
8W 230V	1100lm	3000K	3	<ul style="list-style-type: none"> bianco/white antracite/anthracite corten 	<ul style="list-style-type: none"> 2203/42/L/1/BI 2203/42/L/1/AN 2203/42/L/1/CO
OUT H90					
8W 230V	1100lm	3000K	4	<ul style="list-style-type: none"> bianco/white antracite/anthracite corten 	<ul style="list-style-type: none"> 2203/90/L/1/BI 2203/90/L/1/AN 2203/90/L/1/CO
OUT H180					
8W 230V	1100lm	3000K	5	<ul style="list-style-type: none"> bianco/white antracite/anthracite corten 	<ul style="list-style-type: none"> 2203/180/L/1/BI 2203/180/L/1/AN 2203/180/L/1/CO

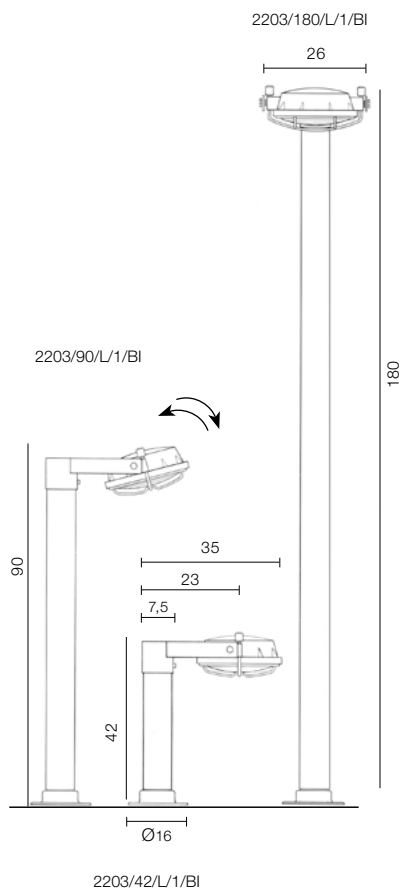

alimentatore elettronico integrato / integrated electronic driver

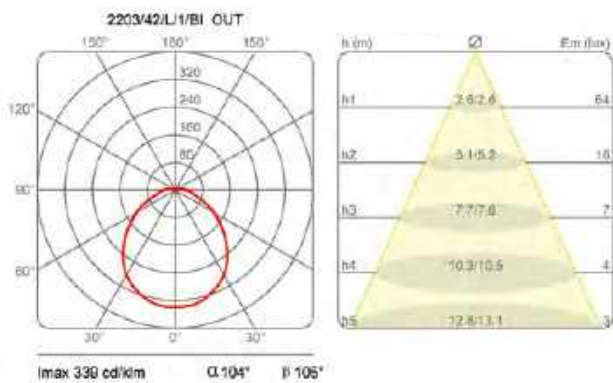



OUT



parete / wall

Lampada da parete a luce diffusa.
Corpo lampada orientabile in resina rinforzata con fibra di vetro, diffusore in policarbonato, griglia e supporto in acciaio inox. Verniciato nel colore bianco, antracite o corten, con vernici poliuretaniche.
Sorgente di luce a LED integrata.

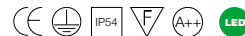
Outdoor wall lamp with diffused light.
Adjustable resin body lamp reinforced with glass fibers, polycarbonate diffuser, stainless steel grid and support. White, anthracite or corten polyurethane paints structure.
Integrated LED light source.



IP54

watt	flusso/flux	CCT	Kg	colore/colour	codice/code
8W 230V	1100lm	3000K	2,5	 bianco/white	1245/L/1/BI
				 antracite/anthracite	1245/L/1/AN
				 corten	1245/L/1/CO

alimentatore elettronico integrato / integrated electronic driver

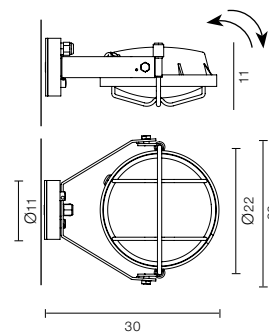

per diagrammi illuminotecnici vedi pagina precedente 506.
for lighting curve see the previous page 506.

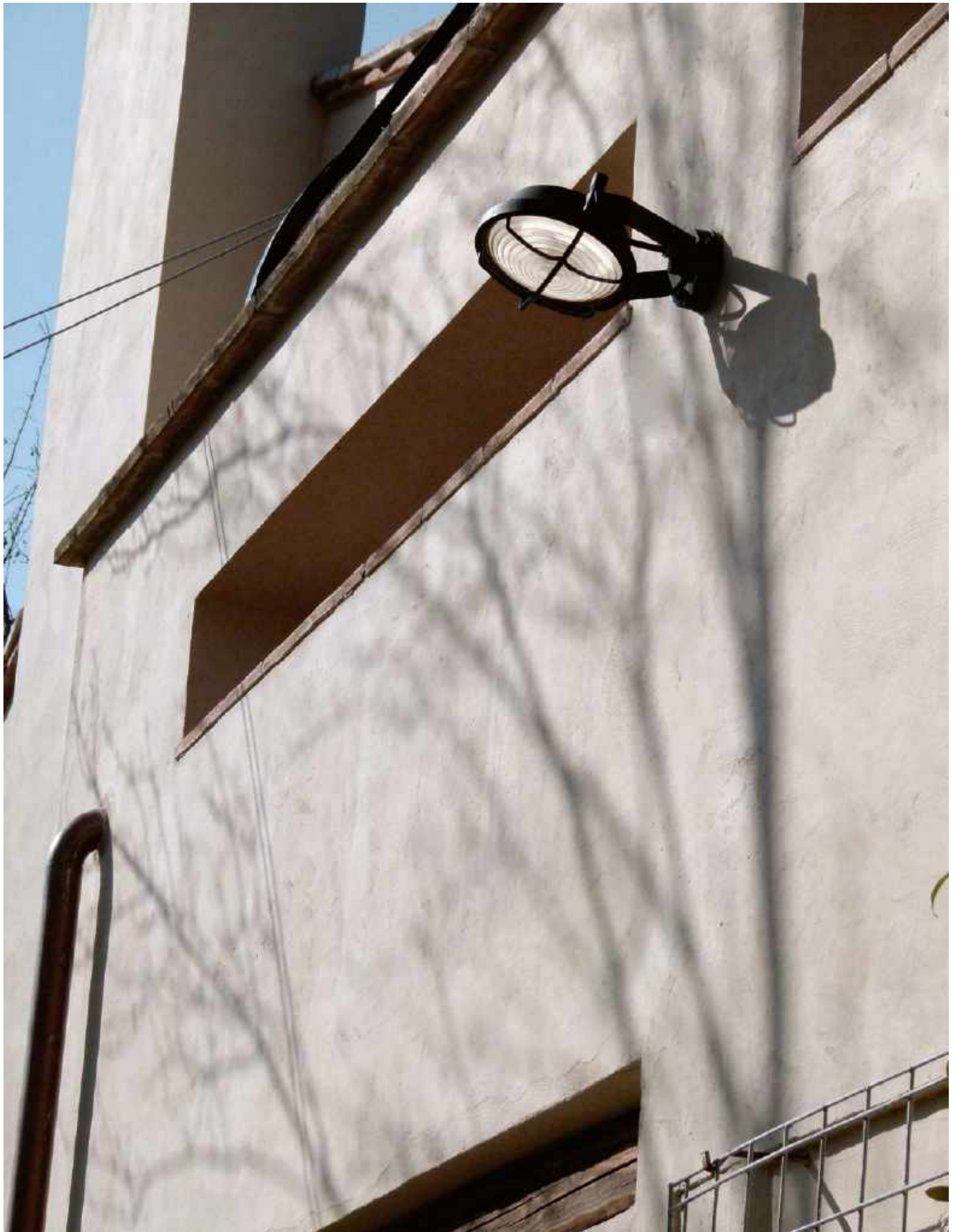

OUT

soffitto-parete / ceiling-wall

Lampada da soffitto o parete a luce diffusa.
Corpo lampada in resina rinforzata con fibra di vetro, diffusore in policarbonato, griglia in acciaio inox. Verniciato nel colore bianco, antracite o corten con vernici poliuretaniche. Sorgente di luce a LED integrata.

Outdoor wall or ceiling lamp with diffused light.
Resin reinforced with glass fibers body lamp, polycarbonate diffuser, stainless steel grid. White, anthracite or corten polyurethane paints structure. Integrated LED light source.

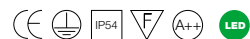

IP54

watt	flusso/flux	CCT	Kg	colore/colour	codice/code
8W 230V	1100lm	3000K	2,5	○ bianco/white	2813/L/1/BI
				● antracite/anthracite	2813/L/1/AN
				● corten	2813/L/1/CO

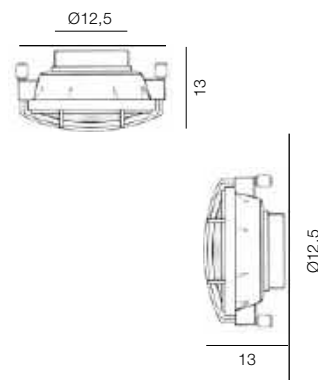

alimentatore elettronico integrato / integrated electronic driver



per diagrammi illuminotecnici vedi pagina precedente 506.
for lighting curve see the previous page 506.





SISTEMA POLO



Una famiglia di lampade da esterno a luce diffusa nelle varie versioni, da terra con palo, da parete, da soffitto e a sospensione, per soddisfare diverse esigenze di illuminazione nel tuo spazio outdoor.

An outdoor family of lamps with diffused light in various versions, floor lamp with rod, wall lamp, and suspension lamp, in order to meet the different needs of lighting in your outdoor space.













POLO

terra / ground

Lampada da terra a luce diffusa.
Corpo in resina rinforzata con fibra di vetro,
diffusore in vetro sabbato, griglia in acciaio
inox, palo in resina in diverse altezze. Finitura
con vernici poliuretaniche nel colore bianco,
antracite o corten.

Per lampadina a LED.

Outdoor standing lamp with diffused light.
Resin reinforced with glass fibers structure,
sandblasted glass diffuser, stainless steel grid,
resin pole in different heights.
Finishing with polyurethane paints in white,
anthracite or corten colour.
For LED bulb.



IP65

watt	Kg	colore/colour	codice/code
POLO H63 1x15W E27 230V	3	○ bianco/white	2213/63/BI
		● antracite/anthracite	2213/63/AN
		● corten	2213/63/CO
POLO H110 1x15W E27 230V	4	○ bianco/white	2213/110/BI
		● antracite/anthracite	2213/110/AN
		● corten	2213/110/CO
POLO H200 1x15W E27 230V	5	○ bianco/white	2213/200/BI
		● antracite/anthracite	2213/200/AN
		● corten	2213/200/CO

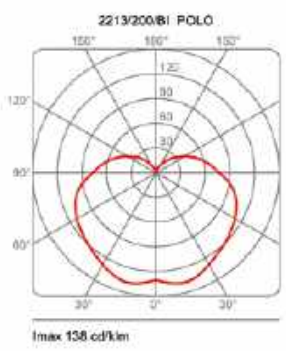
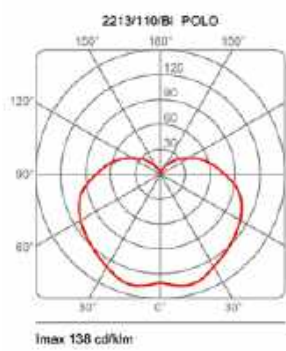
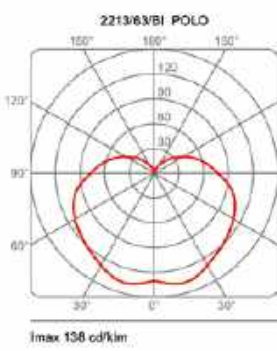
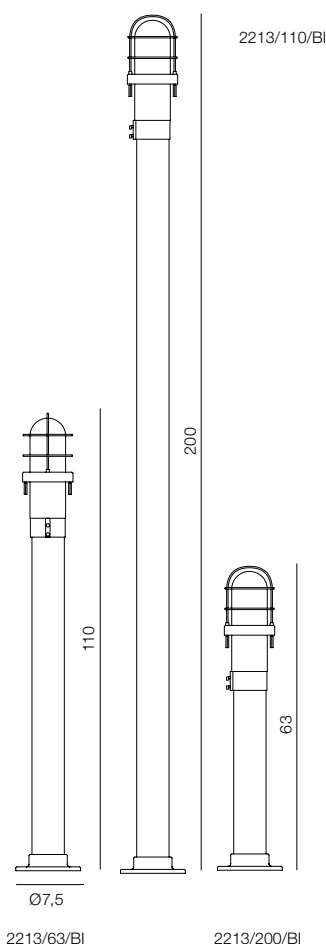



POLO

parete-soffitto / wall-ceiling

Lampada da soffitto o parete a luce diffusa. Struttura in resina rinforzata in fibra di vetro, diffusore in vetro sabbato, griglia in acciaio inox. Verniciato con vernici poliuretane nel colore bianco, antracite o corten. Per lampadina a LED.

Outdoor wall or ceiling lamp with diffused light. Fiberglass reinforced resin structure, sandblasted glass diffuser, stainless steel grid. White, anthracite or corten polyurethane painted structure. For LED bulb.

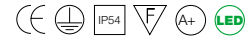

IP54

watt	Kg	colore/colour	codice/code
1x15W E27 230V	1,5	○ bianco/white	2808/BI
		● antracite/anthracite	2808/AN
		● corten	2808/CO

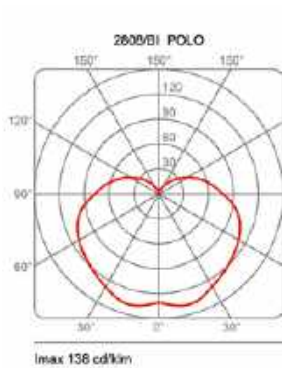
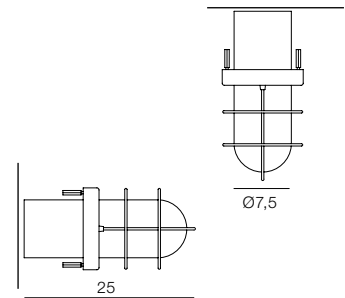







KOALA



Una lampada da parete per esterno a luce diretta e indiretta. Una forma morbida realizzata in stampo in cemento ad alta resistenza. Per illuminare facciate di edifici pubblici e residenziali, e per segnare percorsi. Sorgente di luce a LED.

An outdoor wall lamp with direct and indirect light. A soft shape molded in high resistance concrete. To illuminate facades of public and residential buildings, and to mark paths. LED light source.

KOALA

Una lampada da parete per esterno a luce diretta/indiretta. Struttura stampata in cemento ad alta resistenza con idrorepellente con un processo artigianale, nel colore grigio cemento. Diffusori in vetro satinato. Per sorgente di luce a LED.

An outdoor wall lamp with direct/indirect light. Structure molded in high resistance concrete, made water-repellent with a hand-crafted process, in concrete grey colour. Satin glass diffuser. For LED light source.



IP65

watt	flusso/flux	CCT	Kg	colore/colour	codice/code
2x10W 230V	2x1000lm	2700K	4,7	● grigio cemento/concrete grey	1444/GR

alimentatore integrato / integrated driver

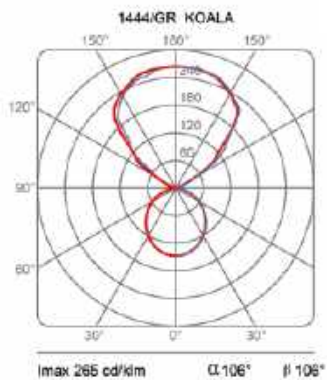
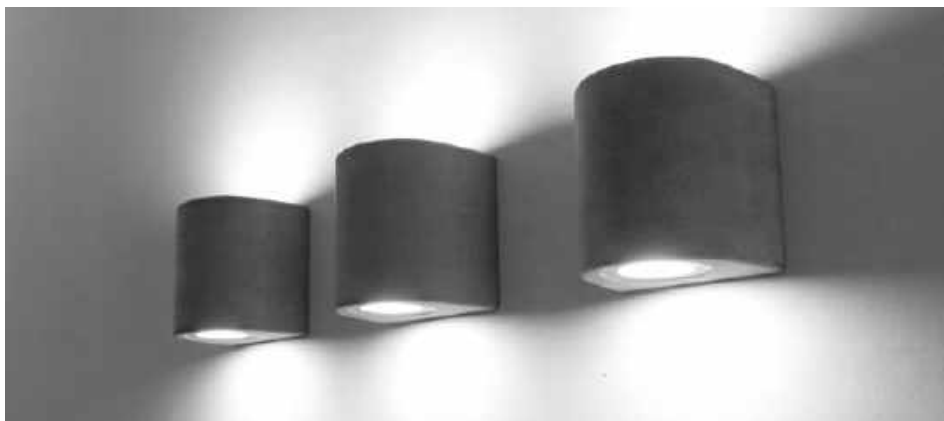
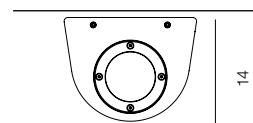
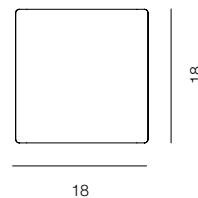





PLAN



Una lampada per esterno, sottile e lineare, con struttura in cemento. Per sorgente di luce a LED, che illumina con una luce indiretta e diffusa, la parete che la supporta e l'ambiente.

A slender and linear outdoor lamp. Its structure in concrete. For LED light source, illuminates the environment and the wall supporting it, with an indirect and diffused light.

PLAN



Una lampada da parete per esterno a luce indiretta. Struttura in cemento ad alta resistenza con idrorepellente con un processo artigianale, nel colore grigio. Per sorgente di luce a LED.

An outdoor wall lamp with indirect light. Grey structure molded in high-resistance concrete, made water-repellent with a hand-crafted process. For LED light source.



IP65

watt	flusso/flux	CCT	Kg	colore/colour	codice/code
13W 230V	1500lm	2700K	4,7	● grigio cemento/concrete grey	1443/P/GR

alimentatore integrato / integrated driver

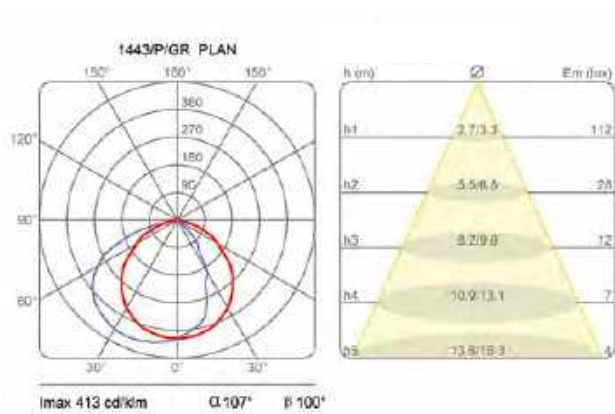
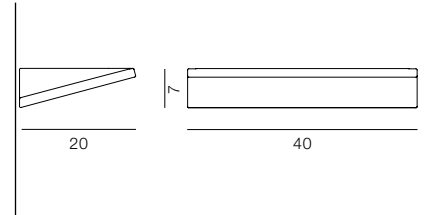





KIKI



Kiki si ispira all'oriente, ricordando con la sua forma morbida e leggera le lanterne di carta cinesi. Nata nella versione a catenaria, oggi anche cordless per diventare la tua "compagna di luce" sia in casa tutti i giorni che in estate nel tuo giardino, per una festa, sul terrazzo, in barca e per una serata romantica. Kiki può avere tante vite. Sempre diverse e fantasiose.

Kiki has the liveliness and lightweight beauty of Chinese paper lanterns. With a pinch of irony, traditions belonging to faraway worlds become contaminated and give life to a chain of lights to be used in a thousand different ways. To decorate a terrace, a garden or an indoor space with lights. To make a party special. Kiki can have many lives. Always different and creative.





T EMILIO













Villa Bernardini, Vicopelago, Lucca

KIKI

catenaria / catenary

Una catenaria a luce diffusa per esterno. Lampada a sospensione composta da 3, 5 o 10 punti luce fissati sul cavo di alimentazione alla distanza di 1m uno dall'altro. Supporto stampato in resina e gomma, cablato per lampadina a LED, diffusore in polietilene stampato in rotazionale. Cavo di alimentazione con spina da esterno in tre lunghezze.

Outdoor suspension catenary lighting with diffused light, composed of 3, 5 or 10 light points mounted on the electrical cable at a distance of 1m from each other. Black resin and rubber molded support, wired up for LED bulbs. Polyethylene diffuser molded with rotational system. Power cable equipped with an outdoor plug, three lengths.

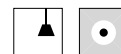

IP65

watt	Kg	colore/colour	codice/code
------	----	---------------	-------------

KIKI 8 m 3x5,3W E27 230V	2	○ bianco/white	21004/3/NE
-----------------------------	---	----------------	------------

cavo / cable 8 m - 3 lampade / lamps

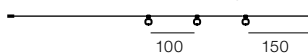

KIKI 10 m 5x5,3W E27 230V	3,2	○ bianco/white	21004/5/NE
------------------------------	-----	----------------	------------

cavo / cable 10 m - 5 lampade / lamps

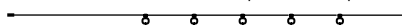

KIKI 15 m 10x5,3W E27 230V	6	○ bianco/white	21004/10/NE
-------------------------------	---	----------------	-------------

cavo / cable 15 m - 10 lampade / lamps

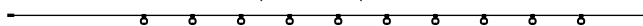

LAMPADINA / BULB

1x5,3W E27	max Ø45mm		5056
------------	-----------	--	------

GANCIO / HOOK	● nero/black	40054/NE
---------------	--------------	----------

gancio optional da avvitare al corpo lampada per fissare kiki ad un eventuale cavo teso di supporto.
optional hook to be screwed to the lamp body to fix kiki to a possible support cable.

CAVO INOX / STAINLESS STEEL INOX CABLE

kit cavo inox 6m per 21004/3/NE	40169.2/NE
kit cavo inox 8m per 21004/5/NE	40169.1/NE
kit cavo inox 13m per 21004/10/NE	40169/NE

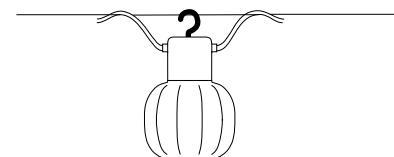
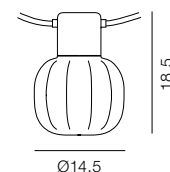



KIKI

cordless

Lampada dimmerabile a luce diffusa per esterno.
Supporto stampato in resina e gomma per LED integrato.
Diffusore in polietilene stampato in rotazionale, maniglia intercambiabile in silicone nei colori: rosso, nero, grigio-verde.
Batteria ricaricabile, con cavo USB, durata batteria 7 ore.
Caricabatteria USB.

Diffused dimmable light lamp for outdoor.
Molded support in resin and rubber for integrated LED.
Diffuser in polyethylene, printed with rotational molding technology. Silicone interchangeable handle, provided in the following colours: red, black and grey-green.
Rechargeable battery, with USB cable, battery life 7 hours.
USB charger.

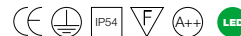

IP54

watt	flusso/flux	CCT	Kg	colore/colour	codice/code
1W 230V	110lm		0,5	○ bianco/white	21004/DIM/CL/NE
caricabatteria USB (opzionale) / USB charger (optional)					40065

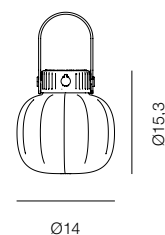

La lampada è completa di maniglia intercambiabile in silicone nei colori nero, rosso o grigio-verde (includere)

The lamp is provided with interchangeable silicone handle in black, red, grey-green colour (included)

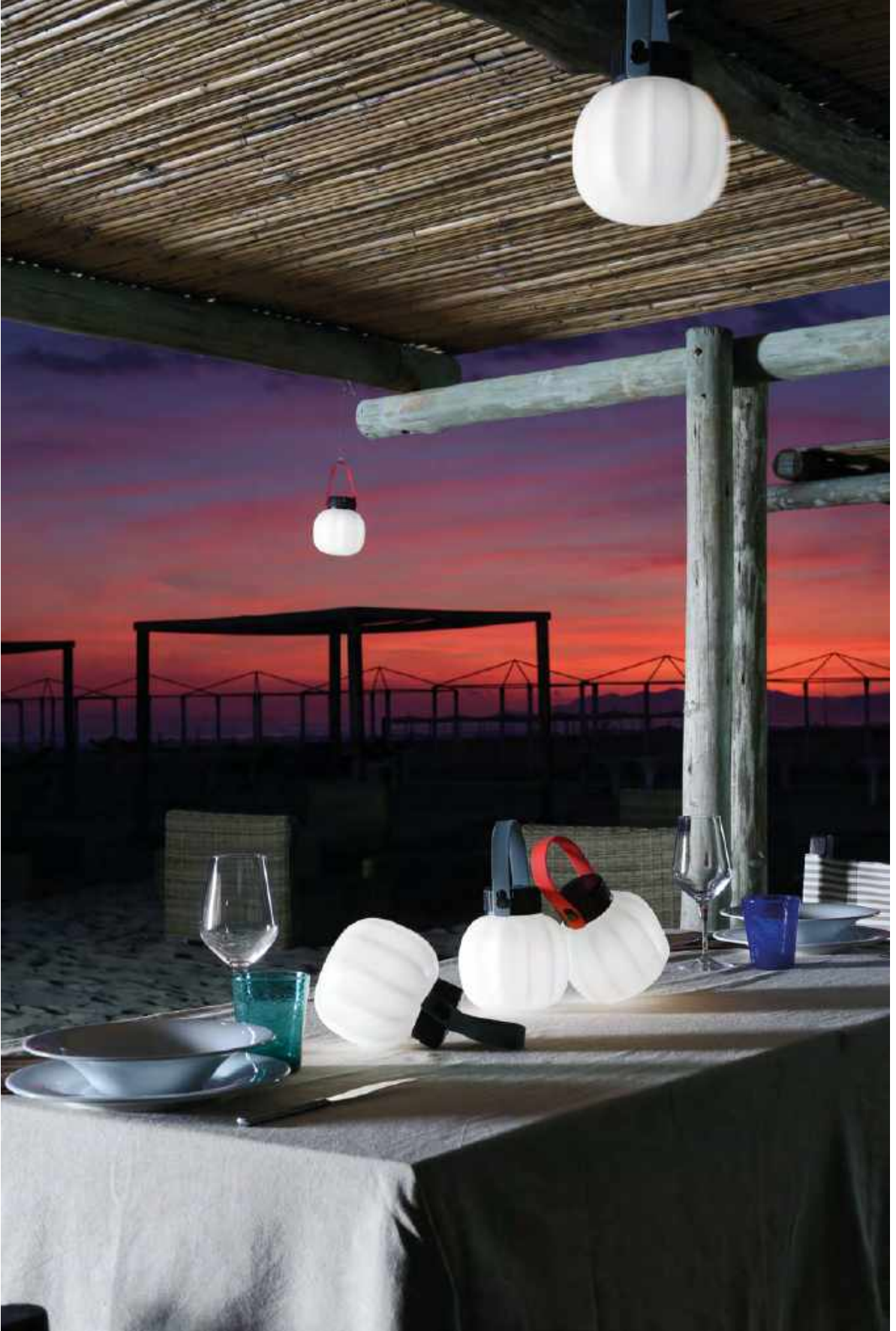

Bagno e ristorante Cavallone, Lido di Camaiore, Lucca



CIULIFRULI



Allegra, leggera e funzionale, Ciulifruli è progettata per essere appesa tra i rami degli alberi, a un gazebo o sospesa al soffitto, da sola o in gruppo, con una base da terra e, nella versione da interno, anche a grappolo e a ragno. Un gioco di forme e colori in grado di ravvivare e illuminare vari spazi.

Cheery, light and functional, Ciulifruli is designed to be hung amidst the branches of a tree, in a gazebo or from the ceiling, alone, with base, or in clusters and spider in the indoor version. A game of shapes and colours that enlivens and illuminates various spaces.

















CIULIFRULI

Una serie di lampade a sospensione per esterno a luce diffusa. In diverse forme e dimensioni stampate in rotazionale. Disponibili cinque diffusori nel colore bianco di diverse misure e cinque supporti in diversi colori: bianco, giallo, verde, azzurro e rosso per comporre la lampada. Supporti predisposti per lampadina a LED.

A series of suspension lamps for outdoor use with diffused light available in different shapes and sizes in rotational molding system. Available five white diffusers in different sizes and five supports in different colours: white, yellow, green, blue and red, to compose the lamp. Supports suitable for LED bulb.

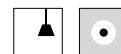

IP65

watt	misure/size	Kg	colore/colour	codice/code
------	-------------	----	---------------	-------------

DIFFUSORI / DIFFUSERS

1) Ø16 H16	1,5	○ bianco/white	30859/BI
2) Ø23 H19	1,5	○ bianco/white	30860/BI
3) Ø15 H29	1,5	○ bianco/white	30861/BI
4) Ø29 H12,5	1,5	○ bianco/white	30862/BI
5) Ø50 H40	2,5	○ bianco/white	30903/BI

SUPPORTI / SUPPORTS

con cavo di alimentazione arancio e spina per lampadina E27 (5m)
with orange power cable and plug for E27 bulb

10W-14W-5,3W E27

1	○ bianco/white	30858/BI
1	● azzurro/light blue	30858/AZ
1	● giallo/yellow	30858/GI
1	● rosso/red	30858/RO
1	● verde/green	30858/VE

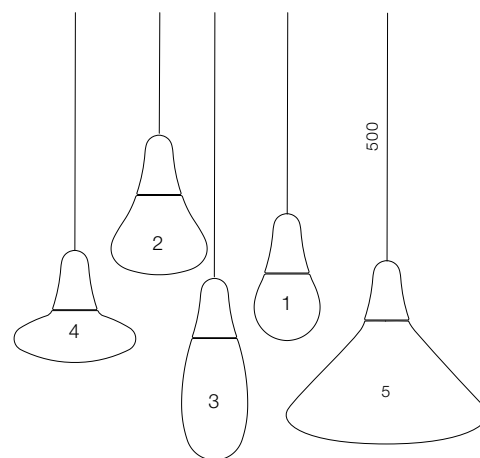

BASE CON ASTA IN METALLO / BASE WITH METAL ROD

base per 1 lampada / base for 1 lamp

Ø60 H223 40039/1

base per 3 lampade / base for 3 lamps

Ø60 H223 40039/3

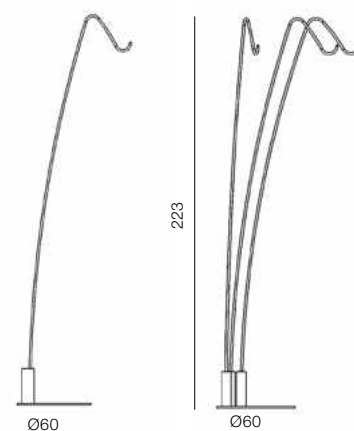

LAMPADINE / BULBS

1x10W E27	max Ø55mm (per diffusori/for diffusers 1-2-3)	5049
1x14W E27	max Ø55mm (per diffusori/for diffusers 5)	5278
1x5,3W E27	max Ø55mm (per diffusore/for diffuser 4)	5056





TRILLY



Una lampada versatile, un cono di luce che ti accompagna nei tuoi spazi outdoor. Puoi usarla in giardino appoggiata a terra nel prato, sul terrazzo, sospesa a un albero o a un gazebo, la puoi spostare da un posto a un altro e anche mettere a parete.

A versatile lamp, a cone of light that accompanies you in your outdoor spaces. You can use it in the garden resting on the lawn, on the terrace, suspended from a tree or a gazebo, you can move it from one place to another and even put it on the wall.





TRILLY

Villa La Badiola, San Pancrazio, Lucca





TRILLY

Lampada per esterno a sospensione da appoggio e da parete, a luce diffusa. Struttura in polietilene stampata con la tecnologia rotazionale. Per lampadina LED. Disponibile in due dimensioni. Gancio per il fissaggio a parete (optional).

Outdoor suspension, floor or wall lamp, with diffused light. Rotational moulded technology in white polyethylene material. For LED bulb. Available in two sizes. Wall fixing hook (optional).

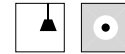

IP65

watt	Kg	colore/colour	codice/code
------	----	---------------	-------------

TRILLY Ø27 1x6W E27 230V	1,5	○ bianco/white	2073/J
-----------------------------	-----	----------------	--------

TRILLY Ø45 1x15W E27 230V	3	○ bianco/white	2073
------------------------------	---	----------------	------

cavo di alimentazione arancio e spina / orange power cable and plug 5m

gancio per il fissaggio a parete / wall fixing hook 30837

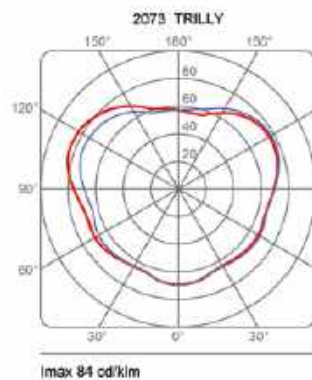
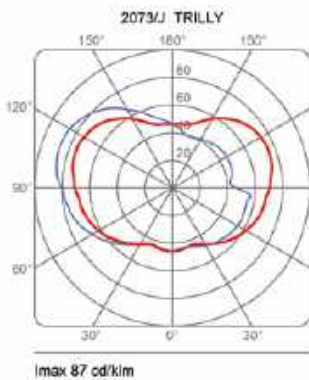
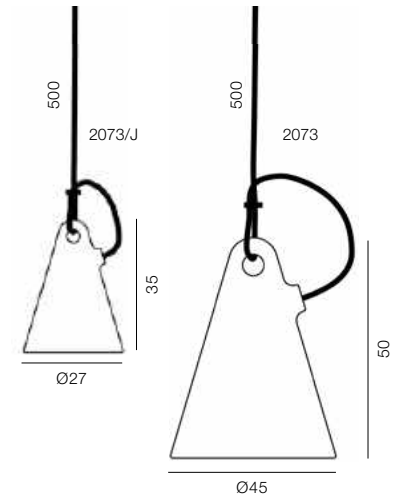





PISTILLO



Un segno di luce diffusa, solitario o in gruppo, disegna con una luce morbida la sua presenza in un percorso, tra gli alberi, in giardino e nello spazio esterno. Sospeso in verticale con il suo gancio o fissato a terra con una base, crea dinamicità, movimento e colore all'ambiente outdoor.

A straight line, alone or in a group, essential and linear or equipped with an upper cone, it outlines its presence in the garden or in other outdoor environments with a soft light. If several elements are placed vertically, horizontally or slanting, they confer dynamism and motion like pistils gently swayed by the wind.





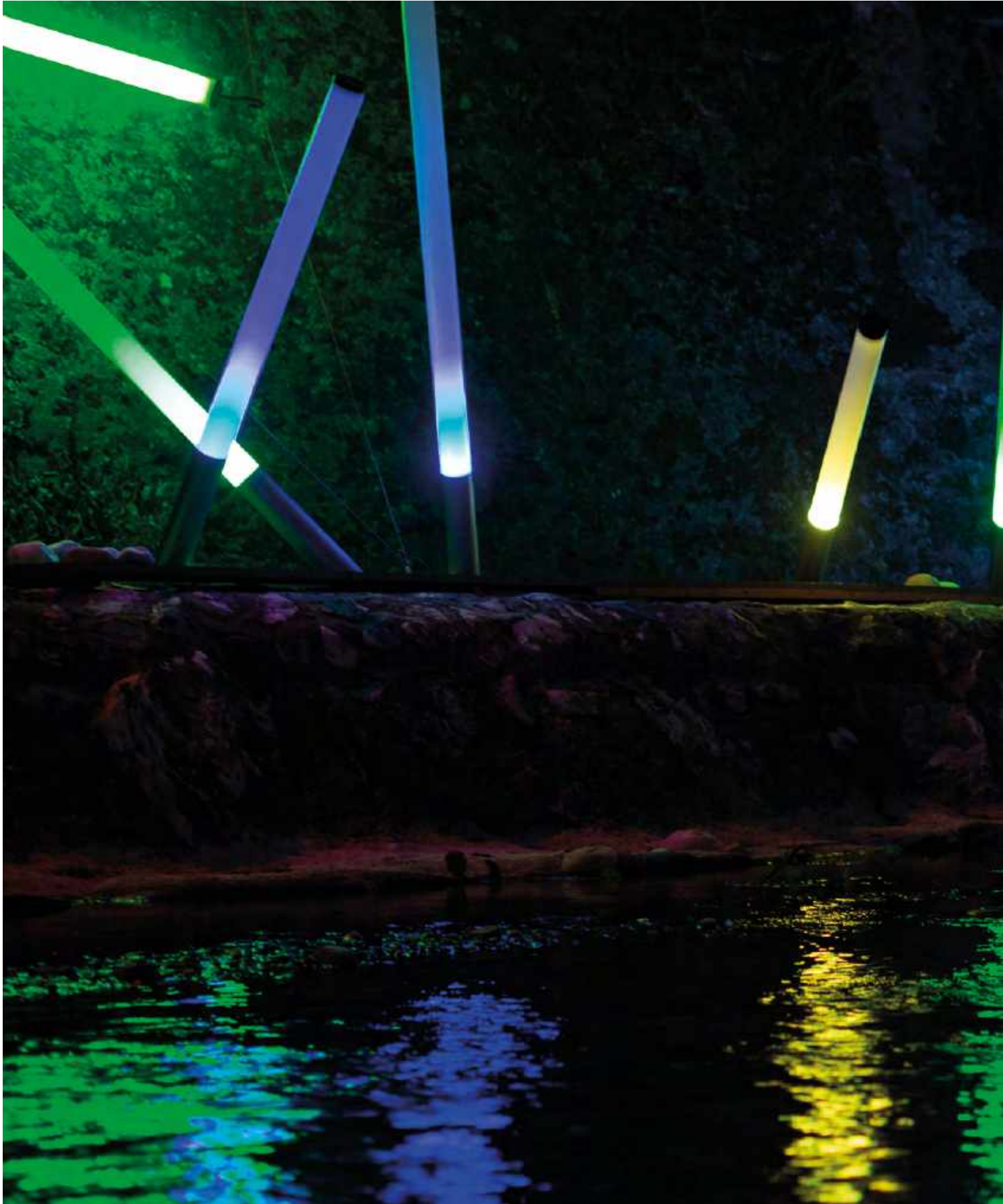

Festival internazionale Cibart, Seravezza, Lucca



PISTILLO

sospensione / suspension

Lampada a sospensione a luce diffusa per esterno. Struttura in metacrilato antiurto. Gancio stampato in resina nel colore nero che può essere fissato da entrambe le estremità secondo le esigenze. Con cavo arancione da esterno di m 5 e spina. La versione Pistillo XS è disponibile con schermo in alluminio verniciato nel colore nero.

Per sorgente di luce a LED con alimentatore elettronico integrato e per lampadina LED.

Suspension lamp with diffused light for outdoor use. Shockproof methacrylate structure. Hook molded in black resin which can be fixed from both ends as needed.

With 5 m orange outdoor cable and plug. The Pistillo XS version is available with black painted aluminium screen. For LED light source with electronic integrated driver and for LED bulb.



IP65

watt	flusso/flux	Kg	colore/colour	codice/code
------	-------------	----	---------------	-------------

PISTILLO				
54W 230V	4150lm	4,7	○ bianco/white	2064/P/L/1

alimentatore elettronico integrato / electronic integrated driver

PISTILLO XS				
1x12W E27 230V		4,7	○ bianco/white	2064/P/XS

schermo in alluminio verniciato per XS
painted aluminium screen for XS

● nero/black 30812/NE

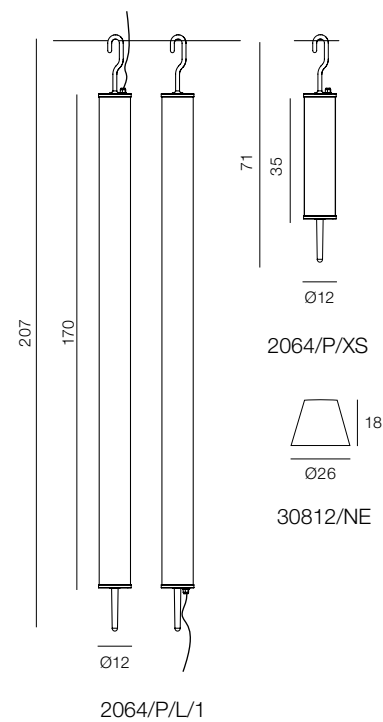

cavo di alimentazione arancio e spina
orange power cable and plug 5m



PISTILLO

terra / floor

Lampada per esterno a luce diffusa per esterno. Struttura cilindrica in metacrilato antiurto opal bianco. Da fissare a terra con base in acciaio satinato o spostabile con una base di appoggio di grande diametro (su richiesta). Cavo arancione da esterno di 5 m e spina. Per sorgente di luce a LED.

Outdoor floor lamp with diffused light. Cylindrical structure in white opal shockproof methacrylate. To be fixed to the ground with satin steel base or movable with a large diameter support base (on request). With 5 m orange outdoor cable and plug. For LED light source.



IP65

watt	flusso/flux	CCT	Kg	colore/colour	codice/code
PISTILLO					
54W 230V	4150lm	3000K	6	○ bianco/white	2294/L/1/DIM
PISTILLO RGB					
12W RGB 230V	1000lm		6	○ bianco/white	2294/L/DIM

alimentatore elettronico dimmerabile integrato / dimmable electronic integrated driver

cavo di alimentazione arancio e spina / orange power cable and plug 3m

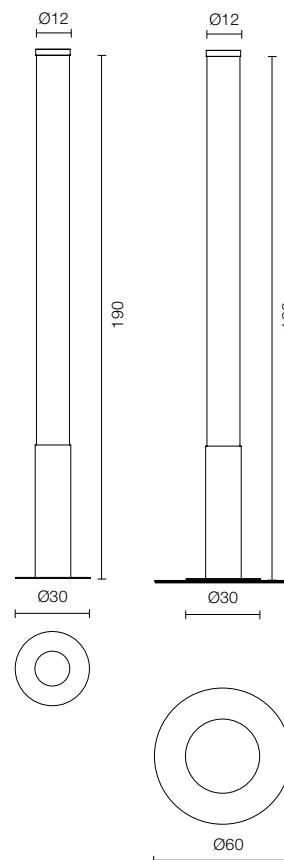

disponibile su richiesta una base di Ø60 per appoggiare la lampada a terra.

available on request a Ø60 base in order to place the lamp on the ground.





BICONICA POL

LIGHTYOU LIKE

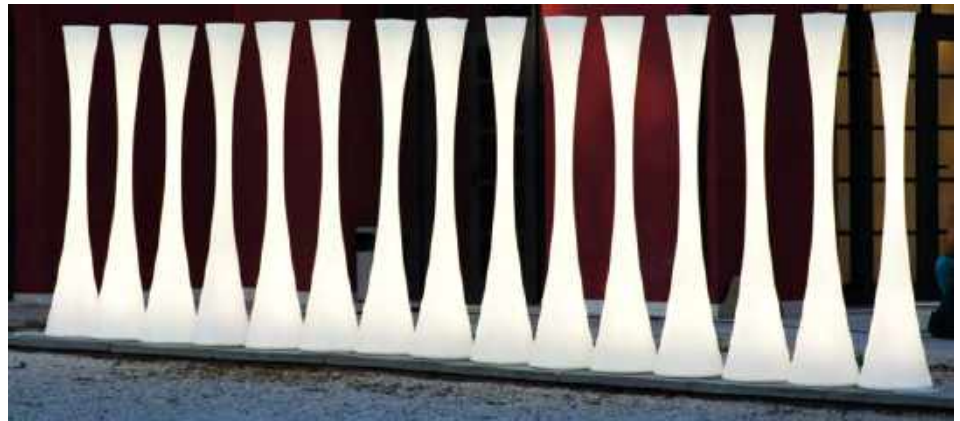

Un segno semplice definisce un doppio volume, che sorprende per la sua forte identità.

Un unico elemento in polietilene stampato con la tecnologia rotazionale. Una fedele compagna per illuminare gli spazi esterni e interni con una luce diffusa, e grazie alla tecnologia Tunable White modulare la temperatura di colore dei LED.

A simple sign defines a double volume that surprises for its strong identity.

A unique element printed with rotational molding technology. A faithful companion to illuminate outdoor and indoor spaces with a diffused light, thanks to the Tunable White LED technology the colour temperature can be modulated.







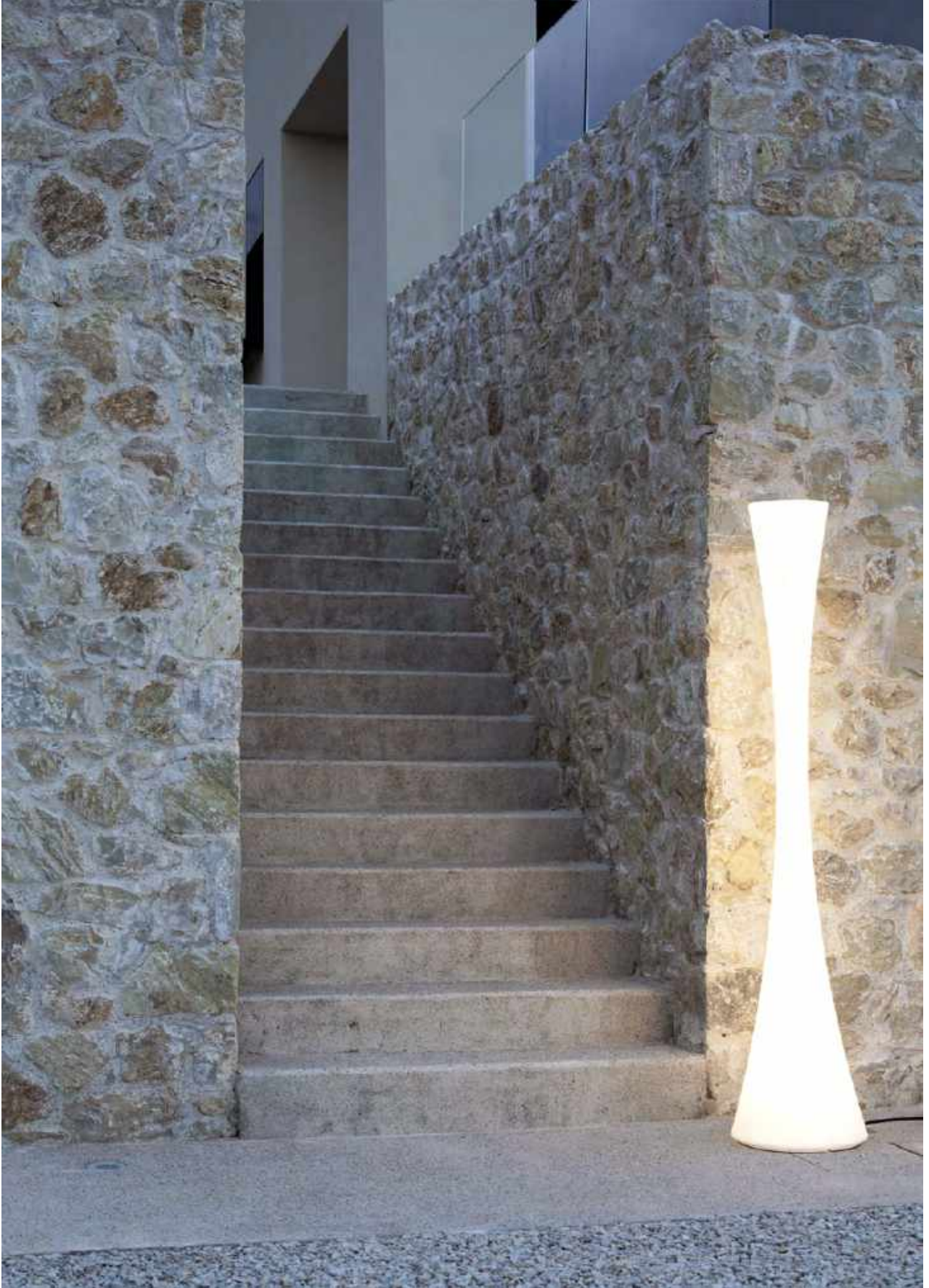

Il Diavoletto S.Gennaro Lucca - arch. Michel Boucquillon

BICONICA POL

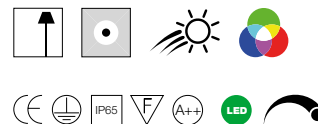

Lampada da terra per esterno a luce diffusa.
 In polietilene stampata in rotazionale.
 Sorgente di luce a LED integrata e alimentatore elettronico incluso.
 Disponibile nella versione Tunable White LED, bianco dinamico con tecnologia LYL (Light You Like), in grado di riprodurre l'andamento della luce naturale, modulando la temperatura di colore dei LED.
 E nella versione RGBW con tecnologia LYL.

Outdoor floor lamp, diffused light.
 Printed with rotational molding technology.
 Integrated LED light source and electronic driver.
 Available in the Tunable White LED version, dynamic white with LYL (Light You Like) technology it is able to reproduce the natural light pattern by modulating the colour temperature of the LED.
 With RGBW LYL technology also.

IP 65

watt	flusso/flux	CCT	Kg	colore/colour	codice/code
------	-------------	-----	----	---------------	-------------

BICONICA POL TUNABLE WHITE

70W 230V	5320lm	2400/6700K	15	○ bianco/white	2217/POL/P/BD/L/1
----------	--------	------------	----	----------------	-------------------

dimmerabile con telecomando / dimmable remote control

BICONICA POL TUNABLE WHITE LYL LIGHT YOU LIKE

70W 230V	5320lm	2400/6700K	15	○ bianco/white	2217/POL/P/BD/BT/L/1
----------	--------	------------	----	----------------	----------------------

dimmerabile con bluetooth / dimmable with bluetooth 

BICONICA POL RGBW LYL LIGHT YOU LIKE

105W RGB 230V			15	○ bianco/white	2217/POL/P/BT/L
---------------	--	--	----	----------------	-----------------

dimmerabile con bluetooth / dimmable with bluetooth 

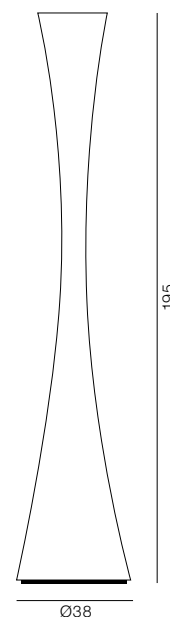

cavo di alimentazione arancio e spina / orange power cable and plug 3 m

le versioni con dispositivo bluetooth Casambi richiedono app iOS e Android (free)
 versions with Casambi bluetooth device require iOS and Android apps (free)

disponibile su richiesta nella versione per ancoraggio fisso a pavimento
 available on request in the version for fixed anchoring to the floor

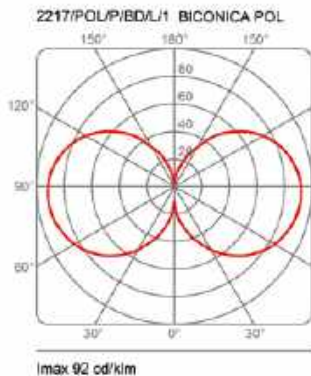



Ex Monastero S. Agostino, Vicopelago, Lucca



GLOUGLOU POL



Una bolla di luce che galleggia sull'acqua della tua piscina. Per sorgente di luce a LED, batteria ricaricabile e con telecomando per variare la luce nei vari colori. Stampata in rotazionale, in polietilene.

A bubble of light that floats on your swimming pool water. With LED light source, rechargeable battery and remote control to change the light in various colours. Printed in polyethylene with rotational molding technology.

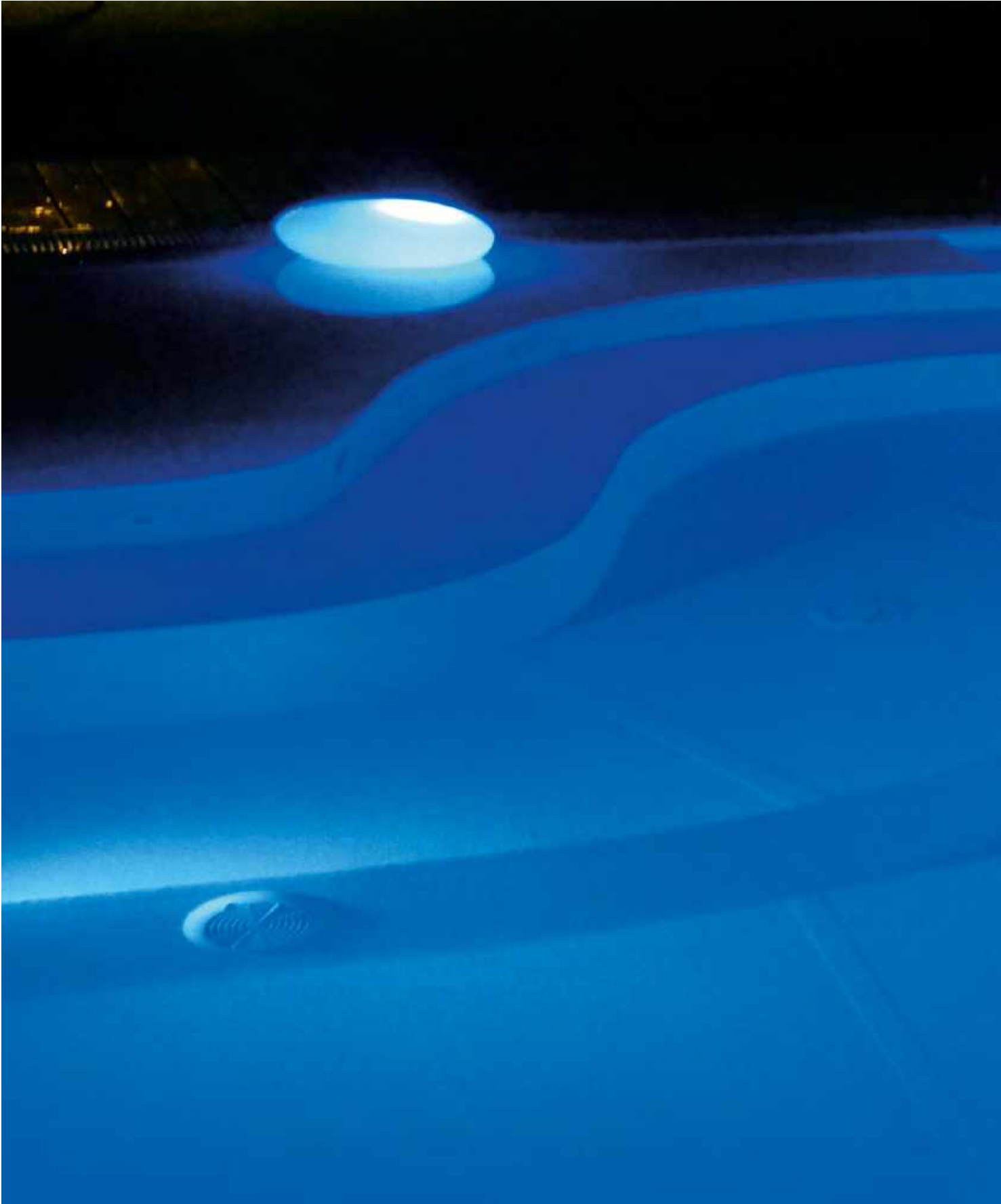

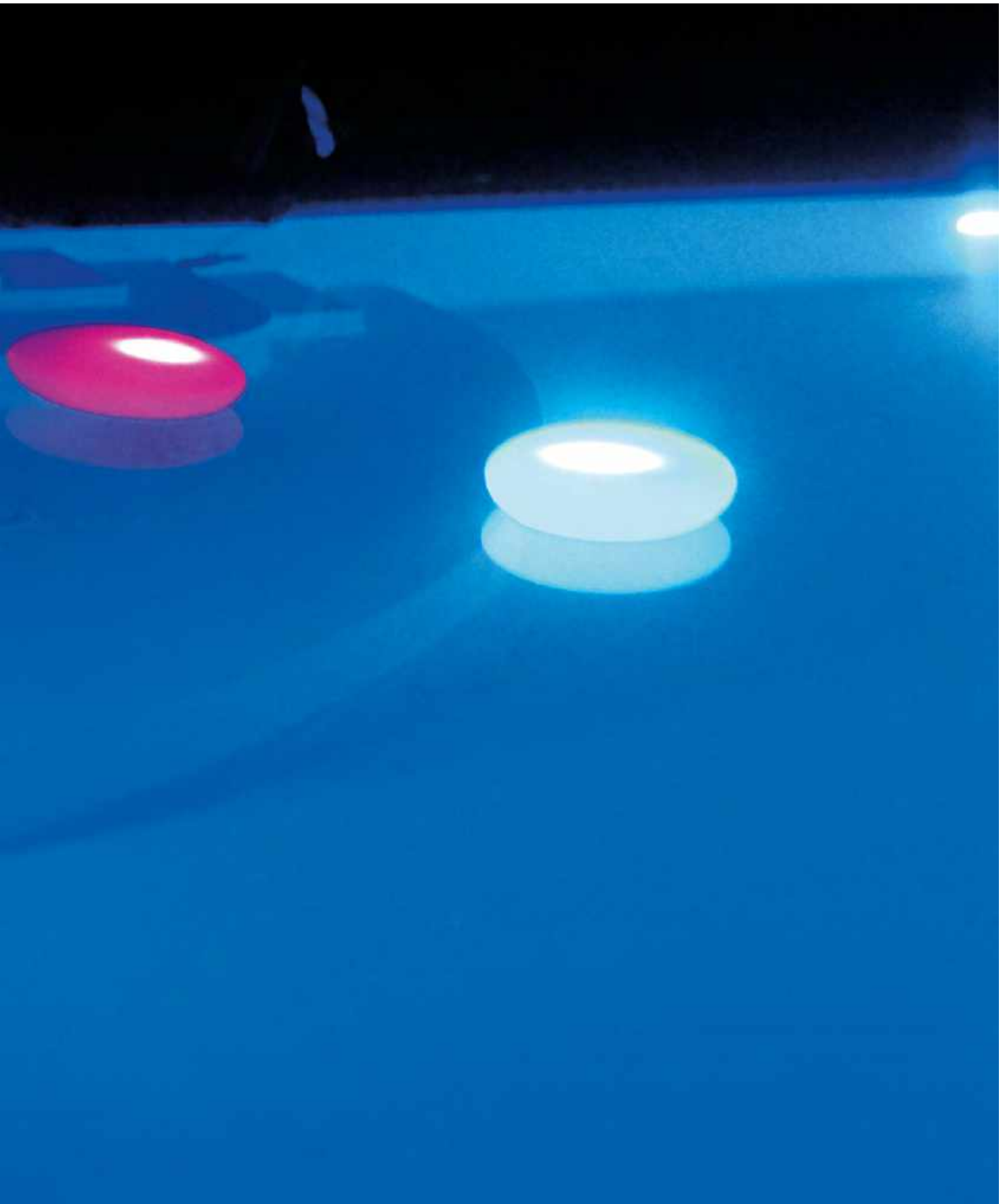

GLOUGLOU POL

cordless

Lampada galleggiante o da appoggio, per esterno a luce diffusa.
Stampata con la tecnologia rotazionale materiale polietilene bianco.
Sorgente di luce a LED RGB, batteria inclusa ricaricabile, durata 6 ore.

Outdoor floating lamp or floor lamp, with diffused light, printed with rotational molding technology, white polyethylene material, RGB LED light source, rechargeable battery included, life 6 hours.



IP67

watt	flusso/flux	CCT	Kg	colore/colour	codice/code
1x1,5W RGB 230V con telecomando / remote control			1,5	○ bianco/white	822/BI

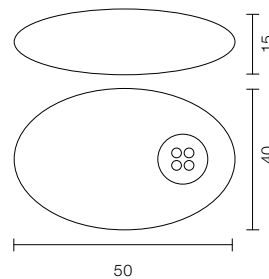



Il Diavoletto S.Gennaro Lucca - arch. Michel Boucquillon

GLOUGLOU POL

con cavo e spina / with cable and plug

Lampada a luce diffusa per esterno da appoggiare sul pavimento o nel prato del tuo giardino, nella versione con cavo di alimentazione. Stampata con la tecnologia rotazionale, materiale polietilene bianco. Per lampadina LED.

Outdoor lamp with diffused light, to be placed on the floor or lawn of your garden, with power cable.

Printed with rotational molding technology, white polyethylene material. For LED bulb.

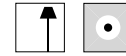

IP65

watt	flusso/flux	CCT	Kg	colore/colour	codice/code
1x6W E14 230V			1,5	○ bianco/white	821/BI

cavo di alimentazione arancio e spina / orange power cable and plug 3m

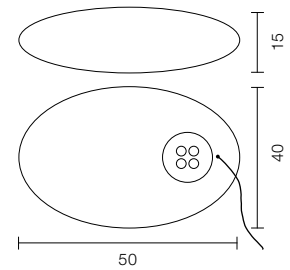





BOWL



Una sfera a luce diffusa in polietilene, da appoggiare nel prato o sul pavimento del terrazzo. La maniglia permette di prenderla e spostarla facilmente nel punto da illuminare.

A polyethylene diffused light sphere, to be placed on the yard or on the floor of a balcony. The handle allows to easily lift it and move it to the right place you want to illuminate.





BOWL

Lampada da appoggio per esterno a luce diffusa. Stampata in rotazionale, materiale in polietilene bianco, particolare maniglia di colore nero stampata in resina.
 Con cavo (3 m) e spina.
 Per lampadina a LED.

Outdoor floor lamp with diffused light. Printed with rotational molding technology, white polyethylene material, black handle in moulded resin.
 With cable (3 m) and plug.
 For LED bulb.

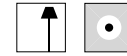

IP65

watt	Kg	colore/colour	codice/code
1x15W E27 230V	2	○ bianco/white	812
cavo di alimentazione e spina / power cable and plug 3m			
picchetto per fissaggio a terra / peg for ground fixing (optional)			40175

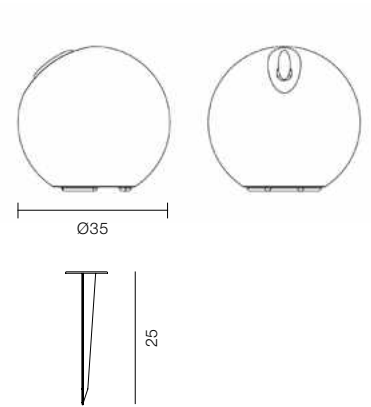





2250



Lampada da esterno su palo, per una illuminazione generale, con sorgente di luce a LED.
Un grande riflettore, un corpo in alluminio, un diffusore in vetro satinato e uno schermo antiabbagliamento, per una luce discreta e riflessa verso il basso.
Adatta per illuminare parchi, giardini e percorsi.

Outdoor lamp on a pole, for general lighting, with LED light source.

With a large reflector and aluminium body lamp. Thanks to the frosted glass diffuser and the anti-glare screen the light is discreet and reflected downwards.
Suitable to illuminate parks, gardens and paths.





2250

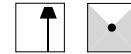

Apparecchio da terra a luce riflessa, su palo in acciaio verniciato nel colore antracite, regolabile in altezza. Corpo lampada completo di alimentatore elettronico, di dissipatore per sorgente di luce a LED, e di schermo antiabbagliamento a lamelle sovrapposte in alluminio verniciato. Diffusore in vetro satinato pyrex con guarnizione in gomma siliconica. Predisporre un plinto in cemento per fissare il palo. IP54

Floor device with reflected light, on a steel pole painted in anthracite colour, adjustable in height. Lamp body complete with electronic driver, heatsink for LED light source, and anti-glare overlapping slatted screens in painted aluminium. Pyrex satin-finish glass diffuser with silicone rubber gasket. A concrete plinth is needed in order to fix the pole.



watt	flusso/flux	CCT	Kg	colore/colour	codice/code
39W 230V	4200lm	3000K	20	● antracite/anthracite	2250/L/1

alimentatore elettronico integrato nel corpo lampada / integrated electronic driver

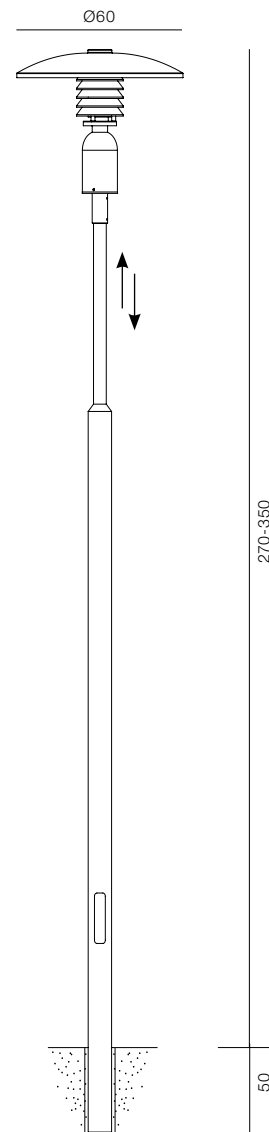



Per essere sempre informati sulle novità, oltre ai cataloghi è utile consultare le sezioni del nostro sito WEB ufficiale: www.martinelliluce.it, di facile consultazione e che viene aggiornato costantemente, per avere un riscontro veloce e approfondito alle vostre esigenze. È possibile effettuare direttamente dal sito il download dei nostri prodotti in 3D e le relative curve fotometriche da utilizzare per i vostri progetti. Martinelli Luce offre la massima collaborazione del proprio studio tecnico per proporre al cliente soluzioni illuminotecniche anche per singoli progetti o risolvere problematiche specifiche.

To keep abreast of all these novelties, in addition to our catalogs, you can browse the different sections of our official website: www.martinelliluce.it. User-friendly and constantly updated, it provides quick & in-depth answers to your needs. Also, you can download our products in 3D and the relative photometric curves that you can use for your projects, directly from the website. Martinelli Luce offers the full collaboration of its technical department to propose customers lighting solutions also for individual projects or to help find answers to specific issues.

informazioni generali
general informations



Alcune fotografie possono mostrare prodotti non standard in quanto realizzati per particolari progetti o installazioni.

Some pictures may show non-standard products as they are made for particular projects or installations.

Su richiesta le lampade possono essere verniciate in altri colori, da valutare al momento dell'ordine.

On request, the lamps can be painted in other colors, to be evaluated at the time of order.

Dove non diversamente specificato i nostri LED sono CRI>85

Unless otherwise specified, our LEDs are CRI > 85

I flussi luminosi (lumen) e la potenza indicata (Watt), evidenziati in ogni singolo apparecchio sono i valori nominali corrispondenti alla relativa sorgente di luce. I dati effettivi sono visibili all'interno delle nostre curve fotometriche in formato Eulumdat scaricabili dal nostro sito web nell'area download, oppure all'interno di ogni singola scheda prodotto.

The luminous fluxes (lumen) and the specified power (Watt), underlined in each device, are the nominal values corresponding to the relative source of light. The real data are visible in our photometric curves in a Eulumdat format, you can download from our web site in the download area, or in each product specifications.

Per le lampade da esterno in cemento, ti ricordiamo che la tecnologia di produzione utilizzata richiede cura artigianale e ogni pezzo è interamente realizzato a mano. Eventuali piccole imperfezioni devono essere considerate normali e non devono essere considerate come difetti, ma piuttosto caratteristiche del materiale utilizzato che rendono ogni pezzo unico e diverso, aumentandone la preziosità.

For outdoor lamps made of concrete, we remind you that the production technology used requires artisan care and each piece is entirely handmade. Any small imperfections are to be considered normal and should not be considered as faults, but rather characteristics of the material used that make each piece unique and different, increasing its preciousness.

Per lampade da esterno si consiglia di utilizzare uno scaricatore di sovratensione.

For outdoor lamps it is recommended to use a surge arrester.

	BI	bianco / white
	NE	nero / black
	AZ	azzurro / light blue
	VE	verde / green
	RO	rosso / red
	AR	arancio / orange
	GI	giallo / yellow
	GR	grigio / grey
	TR	trasparente / transparent
	AL	alluminio / aluminium
	CU	rame / copper
	CP	rame perlato / pearl copper
	AU	oro perlato / pearly gold
	BZ	bronzo / bronze
	AN	antracite / anthracite
	CO	corten / corten
	LU	lucido / polished















martinelli luce

si riserva il diritto di apportare ai propri modelli in ogni momento senza nessun preavviso, qualsiasi modifica ritenesse opportuna.

reserves the right to introduce any changes to its own models, without prior notice.

SIMBOLI / SYMBOLS

TIPOLOGIA DI LAMPADA LAMPS TYPOLOGY

	cordless		lampade sospensione suspension lamps
	foro dell'incasso recessed hole		lampade da terra standing lamps
	easy replace technology		lampade da parete wall lamps
	bluetooth		lampade da soffitto ceiling lamps
	dimmerabile dimmable		lampade per binario elettrificato electrified track lamps
	bianco dinamico dynamic white		lampade da incasso recessed lamps
	comfort acustico acoustic comfort		lampade galleggianti floating lamps





 giunto magnetico
magnetic joint

 low UGR

 RGB

 RGBW

EMISSIONE DI LUCE / LIGHT EMISSION

	luce diretta direct light
	luce indiretta indirect light
	luce diretta indiretta direct indirect light
	luce diffusa diffused light
	luce orientabile swiveling light

FASCIO DI LUCE / LIGHT BEAM

molto stretto very narrow	<10°
stretto narrow	11°-20°
medio medium	21°-30°
largo wide	31°-40°
molto largo very wide	>40°

 Con sorgente di luce a LED nella descrizione di ogni singolo apparecchio, significa che il LED è integrato e non sostituibile dal cliente.

With a source of LED light in the description of each device means that LED is integrated and it is not possible to replace it by customer.

 Con lampadina LED nella descrizione di ogni singolo apparecchio significa che è predisposto per lampadina LED, che può essere sostituita ma non è inclusa.

With LED bulb in the description of each device it means that it is preset to a LED bulb and it is possible to replace it, but it is not included.



DIM Dimmerabile nel codice di ogni singolo apparecchio significa che è fornito di alimentatore con protocollo DALI, PUSH, 0-10V, 1-10V, TRIAC 3, TRIAC 5.

Dimmable in the code of each device means that it is equipped with a DALI, PUSH, 0-10V, 1-10V, TRIAC 3, TRIAC 5 driver protocol.





Alimentatore Triac3 – cavo standard a 3 fili
Triac3 driver – 3 wires standard cable

Alimentatore Triac5 – cavo multipolare a 5 fili
Triac5 driver – 5 wire multipolar cable

CLASSI DI ISOLAMENTO
INSULATION CLASSES

GRADO DI PROTEZIONE IP
IP PROTECTION DEGREE

MARCHI DI CERTIFICAZIONE
MARKS OF APPROVAL



Classe prima, ovvero apparecchio provvisto di isolamento fondamentale in ogni parte e con parti conduttrici accessibili collegate ad un conduttore supplementare di protezione (messa a terra).

Class 1: appliance fitted with basic insulation throughout and with accessible live parts connected to a supplementary safety circuit (ground).



Classe seconda, ovvero apparecchio provvisto di doppio isolamento o isolamento rinforzato senza dispositivi per la messa a terra.

Class 2: appliance fitted with double insulation or reinforced insulation without ground connection.



Classe terza, ovvero apparecchio previsto per il funzionamento a bassissima tensione di sicurezza in cui non si producono tensioni superiori alla stessa.

Class 3: appliance designed for safety extra low voltage (S.E.L.V.) operation in which not higher voltages are produced.



La parte più alta dell'apparecchio può entrare in contatto con superfici normalmente infiammabili. Ove non compaia simbolo grafico, si intende che la parte più alta dell'apparecchio deve essere installata a non meno di 25 mm da un materiale normalmente infiammabile.

The upper part of the appliance may come into contact with normally-inflammable surfaces. If this symbol is not shown, the upper part of appliance must be installed not less than 25 mm from any normally inflammable material.



Apparecchio protetto contro la penetrazione di corpi solidi di dimensioni maggiori a 12 mm e non protetto nei confronti dei liquidi.

Protected against the penetration of solid objects greater than 12 mm and non protected against liquids.



Apparecchio protetto contro la penetrazione di corpi solidi di dimensioni maggiori a 1 mm.

Protected against the penetration of solid objects greater than 1 mm.



Apparecchio protetto contro gli spruzzi d'acqua.

Splashwater-proof device.



Apparecchio protetto contro i getti d'acqua.

Device protected against water jets.



Apparecchio protetto per immersione temporanea.

Device protected by temporary immersion.



CSQ-IQNET - Marchio valido in tutto il mondo, certifica che l'azienda Martinelli Luce attua un sistema di gestione della Qualità conforme alla normativa UNI EN ISO 9001:2015, per garantire un elevato standard qualitativo nella progettazione, sviluppo, fabbricazione e commercializzazione dei propri prodotti.

The CSQ-IQNET label is valid all over the world. It certifies that Martinelli Luce runs a quality management system which complies with the UNI EN ISO 9001:2015 standard, to guarantee a high quality level for what concerns project, development, production and distribution of its products.



ENEC 03 - il marchio ENEC (Certificazione Elettrica relativa alle Norme Europee) è un marchio volontario rilasciato da enti terzi. Certifica che il prodotto è conforme e rispetta i requisiti proposti dalla norma EN 60598 ed è progettato e realizzato in aziende il cui sistema di gestione della qualità soddisfa i requisiti della norma UNI EN ISO 9001:2015.

ENEC 03 - The label ENEC (Electrical Certification concerning European Standard) is a voluntary label granted by third organizations. It certifies that a product complies to the EN 60598 standards and has been designed and manufactured by companies with an approved UNI EN ISO 9001:2015 quality control system.



CE - Dichiara che il produttore produce apparecchi conformi e rispondenti ai requisiti proposti dalla norma EN 60598/1.

CE - Declares that the manufacturer produces light fittings which comply with the requirements of the EN 60598.

Tutti gli apparecchi con sorgente LED sono stati testati secondo la norma IEC62471 o IEC/TR62778 vigenti (sicurezza fotobiologica delle lampade).

All the appliances with LED sources have been tested according to the current IEC62471 or IEC/TR62778 standards (photobiological safety of lamps).

GARANZIA WARRANTY

Martinelli Luce S.p.A garantisce i Prodotti da vizi e/o difetti nella lavorazione o nei materiali per un periodo di 24 mesi dalla data di acquisto dei prodotti (fa fede la fattura di vendita). Per garanzia si intende, ad insindacabile discrezione di Martinelli Luce S.p.A, la sostituzione parziale o totale di parti componenti volte al ripristino delle funzionalità, limitatamente ai vizi di costruzione. La garanzia non copre eventuali difetti o danni per utilizzo non conforme alle istruzioni di installazione e danni derivati dall'utilizzo di prodotti con un grado di protezione non adeguato ad ambienti dove possono essere presenti agenti contaminanti. Essa decade se i prodotti sono stati manomessi o riparati, da personale non appartenente a Martinelli Luce S.p.A. o da personale non espressamente da noi autorizzato per scritto. La garanzia decade altresì in tutte le altre cause quali, in via non limitativa, sono presenti controversie relative ai pagamenti, o non vengono fornite le necessarie informazioni atte a determinare la causa dei guasti, la mancata periodica manutenzione e l'installazione di ricambi su prodotti che non siano ricambi acquistati presso la Martinelli Luce S.p.A. Sono esclusi dalla garanzia danni causati da eventi atmosferici, o da scariche elettriche o sovratensioni, e comunque se il prodotto è posizionato in ambienti non a norma con le leggi vigenti. La garanzia riguarda solo il valore del prodotto e non i costi di trasporto, smontaggio, rimontaggio e perizia. In caso di vizi accertati e tempestivamente denunciati (entro 8 giorni) la Martinelli Luce S.p.A. sarà tenuta alla sola sostituzione, riparazione o riaccredito a propria discrezione dei prodotti difettosi che dovranno essere rispediti nell'imballo originale, con esclusione di qualsiasi diversa ed ulteriore responsabilità per danni che possono verificarsi al cliente o a terzi a seguito ed in conseguenza dell'utilizzo dei prodotti da essa realizzati. Sono esclusi dalla garanzia le lampadine, i materiali sostituibili e soggetti a normale usura (batterie, accumulatori ecc.).

GARANZIA (estensione a 5 anni)

Martinelli Luce mette a disposizione, solo su richiesta, per i propri clienti professionali una garanzia di 5 anni riservata solo ai prodotti Architectural. Si prega di contattare il consulente commerciale della propria zona o direttamente l'azienda per maggiori dettagli in proposito.

Martinelli Luce S.p.A warrants its products to be free from faults and defects in material and workmanship for a period of 24 months from the date of purchase of the products (as certified by the sales invoice). By warranty we mean – following the irrevocable discretion of Martinelli Luce S.p.A – the total or partial replacement of component parts aimed at restoring functionality, limited to structural faults. The warranty does not cover any defects or damages due to use that does not comply with installation instructions and damages arising from the use of products with a level of protection not suitable for environments where contaminating agents may be present. The warranty is void if the products have been tampered with or repaired by people not from Martinelli Luce S.p.A. or by personnel not expressly authorized by us in writing. The warranty is void also in all other cases where, by way of example but not limited to, disputes regarding payments exist, or the information necessary to determine the cause of the failures is not provided, where there is a lack of periodical maintenance and in the event of installation of spare parts on products that are not spare parts purchased at Martinelli Luce S.p.A. Excluded from the warranty are damages caused by atmospheric events or by electrical charges and surges, and in any case if the product is placed in environments that do not comply with current laws in force. The warranty concerns only the value of the product and not transport costs, costs for dismantling, re-assembly and appraisal. In the event of defects ascertained and promptly reported (within 8 days), Martinelli Luce S.p.A. is to be held responsible for replacing, repairing or refunding – at its discretion – the defective products that must be re-shipped in their original packaging, with the exclusion of any different and further responsibility for damages that may arise with the customer or with third parties following the use of the products manufactured by the company. Excluded from the warranty are lightbulbs, replaceable materials and materials subject to normal wear (batteries, accumulators etc.).

WARRANTY (5-year extension)

Martinelli Luce provides a 5-year guarantee for its professional customers, only on request, reserved only for Architectural products. Please contact the sales consultant in your area or the company directly for more details.

INDICE PER CODICE / CODE INDEX

500X	288-306-308	1296/I/DIM/L/1/T/BI	408	1447/14/NE	304	2004/SL/65/DIM/L/1/CU	080
	314-361	1390/L/1/BE/NE	350	1447/32/BI	304	2004/SL/95/DIM/L/1/AU	080
505X	322	1396/S/L/1/O2/BI	422	1447/32/DIM/BI	304	2004/SL/95/DIM/L/1/BI	080
506X	308	1396/S/L/1/Q1/BI	422	1447/32/DIM/NE	304	2004/SL/95/DIM/L/1/CU	080
507X	308	1396/S/L/1/R/BI	422	1447/32/NE	304	2004/SL/95/S/DIM/L/1/AU	082
509X	468-470	1406/NE	214	1448/14/BI	314	2004/SL/95/S/DIM/L/1/BI	082
510X	468-470	1407/C/XL/16D/AN	338	1448/14/DIM/BI	314	2004/SL/95/S/DIM/L/1/CU	082
511X	468-470	1407/C/XL/16D/BI	338	1448/14/DIM/NE	314	2011/110/2/L/1/BI	380
519.1J	360	1407/C/XL/26D/AN	338	1448/14/NE	314	2011/80/L/1/BI	380
519J	360	1407/C/XL/26D/BI	338	1448/35/BI	314	2011J	380
520.1J	360	1407/C/XL/36D/AN	338	1448/35/DIM/BI	314	2035/J/DIM/L/1/BI	090
520J	360	1407/C/XL/36D/BI	338	1448/35/DIM/NE	314	2035/J/DIM/L/1/BI/AR	090
521.1J	360	1407/P/XL/16D/AN	336	1448/35/NE	314	2035/J/DIM/L/1/BI/BI	090
521J	360	1407/P/XL/16D/BI	336	1449/14/BI	314	2053/4/DIM	264
522J	360	1407/P/XL/26D/AN	336	1449/14/DIM/BI	314	2053/4/L/1	264
523.1J	304-360	1407/P/XL/26D/BI	336	1449/14/DIM/NE	314	2057/DIM/L/1/BI	122
523J	304-360	1407/P/XL/36D/AN	336	1449/14/NE	314	2057/DIM/L/1/NE	122
523J/NE	360	1407/P/XL/36D/BI	336	1449/32/BI	314	2057/J/DIM/L/1/BI	122
524.1J	304-360	1407/XL/16D/AN	334	1449/32/BI	314	2057/J/DIM/L/1/NE	122
524J	304-360	1407/XL/16D/BI	334	1449/32/DIM/BI	314	2057/XS/DIM/L/1/BI	122
525.1J	360	1407/XL/26D/AN	334	1449/32/DIM/NE	314	2057/XS/DIM/L/1/NE	122
525J	360	1407/XL/26D/BI	334	1450/2/24/NE	322	2057/XXL/DIM/L/1/BI	140
526J	360	1407/XL/36D/AN	334	1450/24/NE	322	2057/XXL/Q/DIM/L/1/BI	140
5278	558	1407/XL/36D/BI	334	1451/14/BI	308	2063/DIM/L/1	148
5289.2	262	1410/B/AU	216	1451/14/NE	308	2063/L	148
544.1J	356	1410/B/NE	216	1451/32/BI	308	2063/L/1	148
544J	360	1421/NE	210	1451/32/NE	308	2064/P/L/1	574
545J	288-306	1422/O/AN	340	1452/20/BI	290	2064/P/XS	574
	314-361	1422/Q/AN	340	1452/20/J/BI	290	2070/NE	212
565.1J	362	1422/R1/AN	340	1452/20/J/NE	290	2073	566
565J	362	1433/J/NE	234	1452/20/NE	290	2073/J	566
566.1J	362	1433/NE	234	1452/38/BI	290	2080/1/BZ	202
566J	362	1438/NE	322	1452/38/J/BI	290	2080/1/NE	202
567.1J	362	1439/2700/BI	114	1452/38/J/NE	290	2080/2/BZ	202
567J	362	1439/4000/BI	114	1452/38/NE	290	2080/2/NE	202
591J/NE	360	1439/BI	114	1453/AN	470	2080/3/BZ	202
592J/NE	360	1440/2/AN	482	1453/BL	470	2080/3/NE	202
593J/NE	360	1440/2/CO	482	1453/GI	470	2085/DIM/L/1/AN	374
597.1J	362	1440/AN	482	1884/AN	524	2085/J/DIM/L/1/AN	374
597J	362	1440/CO	482	1884/BI	524	2087/NE	208
812	598	1441/20/BI	288	1884/CO	524	2090/DIM/NE	230
821/BI	592	1441/20/DIM/BI	288	1884/S/AN	524	2090/G/DIM/NE	230
822/BI	590	1441/20/DIM/NE	288	1884/S/BI	524	2097/NE	232
1245/L/1/AN	508	1441/20/NE	288	1884/S/CO	524	2098/DIM/L/1/GR	386
1245/L/1/BI	508	1441/38/BI	288	2003/50/DIM/L/1/AN	368	2203/180/L/1/AN	506
1245/L/1/CO	508	1441/38/DIM/BI	288	2004/SL/125/DIM/L/1/AU	080	2203/180/L/1/BI	506
1290/DIM/L/1/AN	416	1441/38/DIM/NE	288	2004/SL/125/DIM/L/1/BI	080	2203/180/L/1/CO	506
1290/DIM/L/1/BI	416	1441/38/NE	288	2004/SL/125/DIM/L/1/CU	080	2203/42/L/1/AN	506
1296/D/DIM/L/1/T/BI	408	1443/GR	532	2004/SL/125/S/DIM/L/1/AU	082	2203/42/L/1/BI	506
1296/DI/DIM/L/1/T/BI	408	1444/GR	528	2004/SL/125/S/DIM/L/1/BI	082	2203/42/L/1/CO	506
1296/HP/D/DIM/L/1/BI	410	1447/14/BI	304	2004/SL/125/S/DIM/L/1/CU	082	2203/90/L/1/AN	506
1296/HP/DI/DIM/L/1/BI	410	1447/14/DIM/BI	304	2004/SL/65/DIM/L/1/AU	080	2203/90/L/1/BI	506
1296/HP/I/DIM/L/1/BI	410	1447/14/DIM/NE	304	2004/SL/65/DIM/L/1/BI	080	2203/90/L/1/CO	506

2213/110/AN	520	2862/DIM/L/1/BI	092	5959/NE	359	21006/250/DIM/BI	044
2213/110/BI	520	2862/J/DIM/L/1/BI	092	5960/BI	359	21006/250/DIM/CU	044
2213/110/CO	520	2862/J/DIM/L/1/BI/AR	092	5960/NE	359	21006/250/DIM/NE	044
2213/200/AN	520	2862/J/DIM/L/1/BI/BI	092	5961/BI	359	21007/170/DIM/AU	046
2213/200/BI	520	2862/M/DIM/L/1/BI/AR	092	5961/NE	359	21007/170/DIM/BI	046
2213/200/CO	520	2862/M/DIM/L/1/BI/BI	092	5962/BI	359	21007/170/DIM/CU	046
2213/63/AN	520	2875/J/L/1/BI	400	5962/NE	359	21007/170/DIM/NE	046
2213/63/BI	520	2876/1/L/1/14/BI	434	5963/BI	359	21007/250/DIM/AU	046
2213/63/CO	520	2876/1/L/1/14/NE	434	5963/NE	359	21007/250/DIM/BI	046
2217/POL/P/BD/BT/L/1	584	2876/1/L/1/35/BI	434	5964/BI	359	21007/250/DIM/CU	046
2217/POL/P/BD/L/1	584	2876/1/L/1/35/NE	434	5964/NE	359	21007/250/DIM/NE	046
2217/POL/P/BT/L/1	584	2878/DIM/L/1/BI	124	5965/BI	359	21008/200/DIM/AU	050
2250/L/1	604	2882/L/1/MS/BI	436	5965/NE	359	21008/200/DIM/BI	050
2275/2/L/1/O2/BI	424	2882/L/1/O2/BI	436	5967	359	21008/200/DIM/CU	050
2275/2/L/1/Q1/BI	424	2882/L/1/R/BI	436	21001/DIM/DK/GI	156	21008/200/DIM/NE	050
2275/2/L/1/R/BI	424	2886/DIM/BI	070	21001/DIM/DK/GR	156	21009/BI	392
2277/L/1/NE	352	2886/G/DIM/BI	070	21001/DIM/DK/VE	156	21009/GR	392
2277/L/NE	352	2886/J/DIM/BI	070	21001/DIM/GI	156	21012/20/BI	292
2293/3/NE	236	2887/BI	332	21001/DIM/GR	156	21012/20/DIM/BI	292
2294/L/1/DIM	576	2887/NE	332	21001/DIM/VE	156	21012/20/DIM/NE	292
2294/L/DIM	576	2892/BI/AU	456	21003/160/DIM/AU	040	21012/20/NE	292
2306/GI	494	2892/BI/BI	456	21003/160/DIM/BI	040	21012/38/BI	292
2306/GR	494	2892/BI/NE	456	21003/160/DIM/CU	040	21012/38/DIM/BI	292
2308/230/70/CO	488	2892/BI/RO	456	21003/160/DIM/NE	040	21012/38/DIM/NE	292
2308/230/CO	488	2893/BI/AU	456	21003/200/DIM/AU	040	21012/38/NE	292
2308/230/J/CO	488	2893/BI/BI	456	21003/200/DIM/BI	040	21013/20/BI	294
2309/AN	468	2893/BI/NE	456	21003/200/DIM/CU	040	21013/20/NE	294
2309/BL	468	2893/BI/RO	456	21003/200/DIM/NE	040	21013/38/BI	294
2309/GI	468	2894/BI/AU	456	21003/300/DIM/AU	040	21013/38/NE	294
2808/AN	522	2894/BI/BI	456	21003/300/DIM/BI	040	21014/20/BI	294
2808/BI	522	2894/BI/NE	456	21003/300/DIM/CU	040	21014/20/NE	294
2808/CO	522	2894/BI/RO	456	21003/300/DIM/NE	040	21014/38/BI	294
2813/L/1/AN	510	2896/BI	457	21004/10/NE	544	21014/38/NE	294
2813/L/1/BI	510	2897/CR	457	21004/3/NE	544	30640	258
2813/L/1/CO	510	2897/CU	457	21004/5/NE	544	30640.1	258
2834/P/L/1/BI	510	2898/BI	342	21004/DIM/CL	546	30640.1/T	258
2835/DIM/L/1/BI	090	2898/J/BI	342	21005/160/DIM/AU	042	30640/T	258
2835/M/DIM/L/1/BI/AR	090	2898/J/NE	342	21005/160/DIM/BI	042	30642	258
2835/M/DIM/L/1/BI/BI	090	2898/NE	342	21005/160/DIM/CU	042	30642.1	258
2858/CG/DIM/L/1/BI	442	5049	558	21005/160/DIM/NE	042	30642.1/T	258
2859/L/1	446	5056	544-558	21005/200/DIM/AU	042	30642/T	258
2860/1/L/1/O2	450	5142.1	306-361	21005/200/DIM/BI	042	30644/DIM/BI	262
2860/1/L/1/O2/NE	450	5142.2	3006-361	21005/200/DIM/CU	042	30644/J/BI	262
2860/1/L/1/Q1	450	5142.3	306-361	21005/200/DIM/NE	042	30645/DIM/BI	262
2860/1/L/1/Q1/NE	450	5955/BI	358	21005/300/DIM/AU	042	30645/J/BI	262
2860/1/L/1/R	450	5955/NE	358	21005/300/DIM/BI	042	30647	258-260
2860/1/L/1/R/NE	450	5956/BI	358	21005/300/DIM/CU	042	30721	262
2860/3/L/1/O2	450	5956/NE	358	21005/300/DIM/NE	042	30728	260
2860/3/L/1/O2/NE	450	5957/BI	358	21006/170/DIM/AU	044	30728.1	260
2860/3/L/1/Q1	450	5957/NE	358	21006/170/DIM/BI	044	30728.1/T	260
2860/3/L/1/Q1/NE	450	5958/BI	359	21006/170/DIM/CU	044	30728/T	260
2860/3/L/1/R	450	5958/NE	359	21006/170/DIM/NE	044	30729	260
2860/3/L/1/R/NE	450	5959/BI	359	21006/250/DIM/AU	044	30729.1	260

INDICE PER CODICE / CODE INDEX

30729.1/T	260	40003/4000/CU	066	40023.1/DIM/BI	110	40063/AN	480
30729/T	260	40003/4000/NE	066	40023/BI	110	40063/CO	480
30775	260-264	40004.1/BI	068	40023/DIM/BI	110	40064/AN	480
30811.1	214-322	40004/AU	068	40024.1/BI	110	40064/CO	480
30812/NE	574	40004/BI	068	40024.1/DIM/BI	110	40065	546
30836	202	40004/CU	068	40024/BI	110	40072	202
30837	566	40004/NE	068	40024/DIM/BI	110	40074.1/GR	176
30858/AZ	558	40005.1/BI	068	40025/BI	110	40074.2/GR	172
30858/BI	558	40005/AU	068	40025/DIM/BI	110	40074.3/GR	178
30858/GI	558	40005/BI	068	40026/BI	109	40074/GR	168
30858/RO	558	40005/CU	068	40027/BI	109	40075	168-172
30858/VE	558	40005/NE	068	40028/BI	109		178
30859/BI	558	40007.1/BI	068	40030/NE	246	40076	168-176
30860/BI	558	40007/AU	068	40031/NE	246	40077	168
30861/BI	558	40007/BI	068	40032/NE	246	40077.1	176
30862/BI	558	40007/CU	068	40033/NE	246	40078	168
30863/BI	558	40007/NE	068	40034/NE	246	40078.1	176
30869/NE	230-232	40008.1/BI	068	40036/NE	247	40079	168
30902	262-264	40008/AU	068	40037/NE	246	40079.1	176
40001/2700/AU	064	40008/BI	068	40039/1	558	40080	168
40001/2700/BI	064	40008/CU	068	40039/3	558	40080.1	176
40001/2700/CU	064	40008/NE	068	40047/BI	109	40081/NE	204-206
40001/2700/NE	064	40010/AU	068	40048/BI	109	40082/NE	204-206
40001/3000/AU	064	40010/BI	068	40049/NE	246	40083/NE	204-206
40001/3000/BI	064	40010/CU	068	40052/NE	246	40084/NE	205-206
40001/3000/CU	064	40010/NE	068	40053/2700/BI	108	40085	204
40001/3000/NE	064	40011/AU	068	40053/4000/BI	108	40086.1/BI	306-361
40001/4000/AU	064	40011/BI	068	40053/BI	108	40086.1/NE	306-361
40001/4000/BI	064	40011/CU	068	40054/NE	544	40086/BI	306-361
40001/4000/CU	064	40011/NE	068	40055/200/DIM/AU	048	40086/NE	306-361
40001/4000/NE	064	40013/AU	068	40055/200/DIM/BI	048	40087/NE	288-290
40002/2700/AU	064	40013/BI	068	40055/200/DIM/CU	048		292-294
40002/2700/BI	064	40013/CU	068	40055/200/DIM/NE	048	40088/AU	052
40002/2700/CU	064	40013/NE	068	40056/AU	048	40088/BI	052
40002/2700/NE	064	40014/AU	068	40056/BI	048	40088/CU	052
40002/3000/AU	064	40014/BI	068	40056/CU	048	40088/NE	052
40002/3000/BI	064	40014/CU	068	40056/NE	048	40091/AU	052
40002/3000/CU	064	40014/NE	068	40057/AU	048	40091/BI	052
40002/3000/NE	064	40015/AU	068	40057/BI	048	40091/CU	052
40002/4000/AU	064	40015/BI	068	40057/CU	048	40091/NE	052
40002/4000/BI	064	40015/CU	068	40057/NE	048	40093/AU	052
40002/4000/CU	064	40015/NE	068	40058/AU	048	40093/BI	052
40002/4000/NE	064	40017	069	40058/BI	048	40093/CU	052
40003/2700/AU	066	40020/2700/BI	108	40058/CU	048	40093/NE	052
40003/2700/BI	066	40020/4000/BI	108	40058/NE	048	40095/AU	052
40003/2700/CU	066	40020/BI	108	40059/AN	480	40095/BI	052
40003/2700/NE	066	40021/2700/BI	108	40059/CO	480	40095/CU	052
40003/3000/AU	066	40021/4000/BI	108	40060/AN	480	40095/NE	052
40003/3000/BI	066	40021/BI	108	40060/CO	480	40096	053
40003/3000/CU	066	40022/2700/BI	108	40061/AN	480	40097/AU	053
40003/3000/NE	066	40022/4000/BI	108	40061/CO	480	40097/BI	053
40003/4000/AU	066	40022/BI	108	40062/AN	480	40097/CU	053
40003/4000/BI	066	40023.1/BI	110	40062/CO	480	40097/NE	053

40098/BI	304	40141/LU	276	40165	290-294
40098/NE	304	40142/LU	276	40166	460
40101/NE	205	40143/LU	276	40166	488
40102	204	40144/LU	276	40828/L/1/BI	138
40103/BI	304	40145/BI	304	40829/L/1/BI	138
40103/NE	304	40145/NE	304	40830/GR	139
40105/GR	500	40146/BI	304	40831/GR	139
40106	500	40146/NE	304	40834	139
40107	500	40147.1/BI	110	40835/BI	139
40108	500	40147.1/DIM/BI	110	40854/L/1/BI	138
40109	500	40147/BI	110		
40110	500	40147/DIM/BI	110		
40111	494	40148/14/BI	434		
40112.1/BI	174	40148/14/NE	434		
40112.1/VE	174	40148/35/BI	434		
40112/BI	168	40148/35/NE	434		
40112/BI	172	40149/14/BI	434		
40112/BI	174	40149/14/NE	434		
40112/VE	168	40149/35/BI	434		
40112/VE	172	40149/35/NE	434		
40112/VE	174	40150/14/BI	434		
40114/BZ	202	40150/14/NE	434		
40114/NE	202-247	40150/35/BI	434		
40115/NE	204	40150/35/NE	434		
40116/NE	204	40151/14/BI	434		
40117/NE	205-206	40151/14/NE	434		
40118/NE	205	40151/35/BI	434		
40119	170	40151/35/NE	434		
40120	170	40152/14/BI	434		
40121	170	40152/14/NE	434		
40122	170	40152/35/BI	434		
40124/BI	110	40152/35/NE	434		
40124/DIM/BI	110	40153/14/BI	435		
40128/AU	053	40153/14/NE	435		
40128/BI	053	40153/35/BI	435		
40128/CU	053	40153/35/NE	435		
40128/NE	053	40154/14/BI	435		
40129/NE	205	40154/14/NE	435		
40130/NE	205	40154/35/BI	435		
40131/BI	304	40154/35/NE	435		
40131/NE	304	40155/BI	435		
40132/GR	172	40155/NE	435		
40132/GR	178	40156/BI	435		
40133/GI	156	40156/NE	435		
40133/GR	156	40157/BI	435		
40133/VE	156	40157/NE	435		
40135/2700/BI	108	40158/NE	435		
40135/4000/BI	108	40159	176		
40135/BI	108	40160/NE	247		
40137/NE	246	40161/NE	206		
40138/MC/LU	276	40162/NE	206		
40139/MC/LU	276	40163	206		
40140/LU	276	40164	290-294		



ART DIRECTION

Emiliana Martinelli

PHOTOGRAPHY

Simone Baldocchi
Benvenuto Saba
Emiliana Martinelli
Marco Ghilarducci
Bruno Malegue
Stefano Anzini
Saverio Lombardi Vallauri
Donal Murphy Photography
Andrea Anoni
Vincenzo Oliviero
Luigi Rinaldelli
Lampfeber

POST PRODUCTION

Grafiche Martinelli
per foto B. Saba
Francesco Bonuccelli,
Andrea Benassi,
Laura Bartelloni

LAYOUT

Stefano Citti

3D VISUALIZATION

Tredistudio
Bieffe Rendering
Enrico Capanni
Massimo Farinatti
Kalin Gemignani
Marco Ghilarducci
Niccolò Benigni
PLS design - Lorenzo Perini

EDITING OF TEXT

Emiliana Martinelli
Giovanni Silvano
Marco Ghilarducci

PRINTING IN ITALY

Grafiche Martinelli - Firenze

EDITION

marzo 2021 © all rights reserved



martinelli luce spa via Teresa Bandettini 55100 Lucca - Italy
+39 0583 418315 | www.martinelliluce.it | info@martinelliluce.it
showroom | via S. Lucia 9, 55100 Lucca | + 39 0583 496254 | showroom@martinelliluce.it

ARCH

ITECT

URAL

