

BROKIS®

PRICE LIST 2023
OVERSEAS EUR

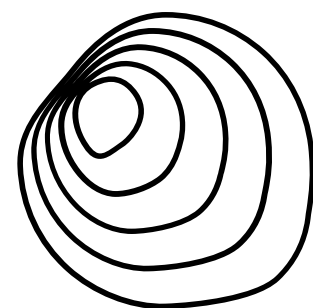

OVERSEAS EUR
SRP (Suggested Retail Price) VAT Excl.
Valid from 01.04.2023

NEWS

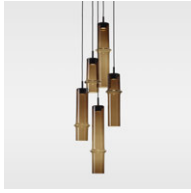
**BAMBOO FOREST**

Accent, atmosphere, variability, subtlety.



p. 53

**TROTTOLA**

Memories, gentle glow, play on forms, mobility.



p. 54

**ELO**

Elegant, sculptural, scenographic, monumental, sustainable, minimalistic.



p. 55

**OVERLAY**

Noblesse, linearity, symbiosis of contrasts, inspired by architecture.



p. 51

**PRISMA**

Dominance, extravagance, thrill, fire, revolution.



p. 52

**ORBIS**

The world in a grain of sand, eternity in a soap bubble, peace in a perfect shape.



p. 49

**DOUBLE**

Transparency, mystery, complementary couple that shines and never splits.



p. 50

**MUFFINS**

INTERIOR, ACCESSORIES
table / floor / pendant

p. 9 - 10

**BALLOONS**

INTERIOR
table / floor

p. 11

**SHADOWS**

INTERIOR, EXTERIOR
pendent

p. 12 - 14

**MEMORY**

INTERIOR
ceiling / wall

p. 15

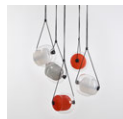
**CAPSULA**

INTERIOR
pendent

p. 16

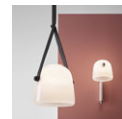
**MONA**

INTERIOR
pendent / floor / wall / table

p. 17

**WHISTLE**

INTERIOR
pendent

p. 18

**FLUTES**

INTERIOR
pendent

p. 19

**NIGHT BIRDS**

INTERIOR, EXTERIOR
pendent

p. 20 - 21

**LIGHTLINE**

INTERIOR
table

p. 22

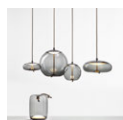
**KNOT**

INTERIOR, BATTERY POWERED
pendent / table / floor / battery

p. 23 - 25

**PURO**

INTERIOR
pendent / floor

p. 26 - 31

**MACARON**

INTERIOR
table / floor

p. 32

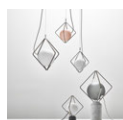
**JACK O'LANTERN**

INTERIOR
table / pendent / wall

p. 33

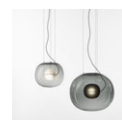
**BIG ONE**

INTERIOR
pendent

p. 34



IVY
INTERIOR, BATTERY POWERED
pendent / table / floor / wall / ceiling / battery

p. 35 - 39



AWA
INTERIOR
pendent

p. 40

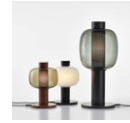

BONBORI
INTERIOR, EXTERIOR
table / floor / wall

p. 41 - 42



SFERA
INTERIOR, BATTERY POWERED
pendent / table / battery

p. 43 - 44

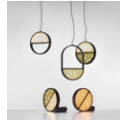

GEOMETRIC LIGHT
INTERIOR
pendent / table / floor

p. 45



PLANETS
INTERIOR
pendent

p. 46



DOME NOMAD
BATTERY POWERED
table / floor / battery

p. 48

BROKIS PRICE LIST – UPDATES AND IMPORTANT TIPS**NOVELTIES**

- Effective as of 1 April 2023, this price list has been expanded with the new collections BAMBOO FOREST, TROTTOLA, and ELO. There are also new variants in the OVERLAY, DOUBLE and MEMORY collections. The new lights can be found in the price list on the page of the given collection and are marked NEW. Collections that have been partially changed, e.g. the addition of a new glass, are marked UPDATE.
- The global situation is continuing to push prices higher, and this affects not only BROKIS but the entire supply chain, including the glassworks. This pricelist must reflect the current situation, thus the prices of the collections have been raised. The latest increase is less than the current rate of inflation. We have analysed all prices very carefully with regard to current input costs.
- The price list also includes the following changes:
 - o The price of the light applies to the non-dimmable version. For the dimmable versions DIM or DIM (TW) – TUNABLE WHITE, a surcharge will apply. Tunable white is available in selected collections only.
 - o Tunable White lets the user adjust the colour temperature of the light source. This solution bears the designation DIM (TW). When ordering standard lights, the colour temperature must be specified. The colour temperature of Tunable White lights can be adjusted as needed from warm white (2700K), which is ideal for relaxation and casual meetings, to cold white (6500K), which supports alertness and concentration.
 - o In 2023, the BIG ONE collection will undergo significant technological innovation that will substantially increase the output of the light and facilitate handling. Due to these extensive modifications, BIG ONE lights are available under the new codes PC1335 and PC1336.
 - o The MONA collection now offers glass in a smoke brown variant.
 - o AWA is available with a new finish on the upper part of the glass – gloss sandblasted.
 - o JACK O'LANTERN now has only one price category (A), as the fixture with liquid-metal coating (copper, chrome, black chrome) has been discontinued. The textured matte black powder coating is still available.
 - o The TRIMLESS CEILING CONNECTION enables a minimalistic connection within drywall ceilings and thus provides a clean look for the overall installation. This feature is indicated in the price list with a TRIMLESS icon on the page of the given collection. Clicking the icon will take you to a webpage with details, a video, and the data sheet.
 - o It is newly possible to select CASAMBI dimming with some of our collections. The option of CASAMBI dimming is indicated in the pricelist in the dimming systems section of the collection with the surcharge for this dimming.
 - o In the MONA collection, a connector has been implemented and the wooden components have been replaced with metal ones. These changes bring significant technological improvements, such as easy maintenance and quick replacement of the light source and glass.
- The technical parameters of the light source (lm, K, RA, etc.) are specific to the light source only. These values may vary depending on the type of light, the colour of the glass, metal components, and other characteristics that can reduce luminosity. For accurate light intensity values, work with the LDT files, which you can access in the price list by clicking on the QR code in the upper left corner of the page of a given collection.

CONTACT:

TIPS FOR WORKING WITH THE PRICE LIST IN ELECTRONIC FORM

- Use the interactive index for faster collection searches. Clicking on a collection name in the index takes you to the page for the given collection in the PDF. You can return to the index by clicking on the button labelled Back to Index in the bottom right corner of the page of a given collection.
- The QR codes in the PDF are website links – clicking on a QR code takes you to the relevant webpage.
 - o QR code Current Price List – takes you to the latest price list in PDF and all Excel price lists.
 - o The QR codes on the pages of individual collections take you to a shared data store, where you'll always find the latest files for a given collection (product sheets, 3DS, DWG, photographs, and much more).
 - o The last page of the price list – other useful links (PR kit, social media, technical information, etc.).
- The QR codes also work on mobile devices with integrated camera.
- For easier sharing of information on each of the BROKIS collections, we have added the word SHARE beneath the QR code in the upper right corner of the page. By clicking on it, a new email will be automatically generated in your inbox (you must have your email client set up properly) with a download link for all the files for the given collection. You can then share this link with your sales partners.
- Among the QR codes on the last page of the price list is one called VIRTUAL PROJECTS – a singular virtual presentation highlighting the uniqueness of our collections in a realistic online setting. Launched at the beginning of 2022, Boutique Hotel BROKIS continues in the success of our earlier Virtual Villa. In the Autumn 2022 was launch of SKY OFFICE, showcasing the use of BROKIS lights in yet another important setting.
- The pictograms of the lights with dimensions on the pages with prices for specific collections are interactive. Clicking on a light pictogram (PC) takes you to a 3D rendering of the given product.
- The CLICK & SAFE icon in the bottom left section of the pages of selected collections (e.g. PURO) links to the BROKIS website for animations demonstrating the advantages of the BROKIS connector.
- The TRIMLESS icon located in the lower left of the page is linked to a BROKIS webpage containing more technical information about this system, a video, and an overview of which collections offer it.
- Other icons in the bottom right part of the pages (e.g. IP, dimming, etc.) for certain collections link to the BROKIS website, where you will find a legend explaining the individual symbols.

CONTACT:

GENERAL SALES CONDITIONS

- SRP (Suggested Retail Price), VAT Excl.
- Standard lead time 6–8 weeks (does not apply to custom orders). Orders of large quantities or with due payment may have longer lead times.
- Payment by bank transfer according to the invoice and the agreed payment conditions.

IMPORTANT REMARKS

- In e-mail correspondence concerning an order or a claim, please always use the BROKIS case-number in the subject of the e-mail (CSxxxxxx)
- Brokis lights are always supplied with LED sources unless otherwise stated.
- Table and floor lights are equipped with either a dimmer or a switch.
- For information on standard lengths of pendant lights, please refer to the separate price list section on pages 56-58.
- Slight differences in colouration are inherent to the production of handblown glass, yet they must remain within tolerance. When ordering replacement glass for lights in any of the existing collections, we will make every effort to come as close as possible to your exact colour tone; however, we can not guarantee precisely the same colour. BROKIS always requires a few photos of the particular colour shade on a white back-ground in order to best determine the colour.
- Please carefully read the cleaning instructions included in this price list.
- For a faster and easier ordering process or resolution of a claim, downloading the important documents, please use the MY BROKIS platform at www.mybrokis.cz.

TRANSPORTATION AND CLAIMS

- When taking delivery of products from our forwarding companies, you will be requested to sign to a delivery confirmation document verifying you have received the consignment. Without your signature, the driver cannot release the products to you. Before signing the delivery confirmation document for the driver, we recommend you check all the boxes and the condition of the products.
- You can accept the products correctly in the following ways:
 1. If the boxes have visible damage, and you suspect that the products inside are also damaged, you have the right to refuse delivery.
 2. If the boxes are obviously damaged, but the condition of their contents is not recognizable from the outside, or if the products in the boxes are apparently broken, you can accept delivery, but you must describe the damage in writing in the delivery confirmation document.
 3. The boxes may be in good condition, but you are still entitled to make a claim with us for damage discovered after the driver has left. It is important that you inform us within a maximum of 5 days after receiving the goods; otherwise, we cannot proceed with the claim against the forwarding company. Any claims made with us beyond the five-day limit will be rejected.
- If the products have been damaged during transportation, please send photos of the damaged box(es), the pallet, all labels on the boxes, and the products inside the box(es).
- Claims are only accepted with a completed official BROKIS Claim Form, which must be submitted together with necessary photos in the BROKIS online platform MY BROKIS - www.mybrokis.cz.
- Carefully read the BROKIS Terms and Conditions, which can be downloaded from www.brokis.cz.

Current price list (PDF and excel)**CONTACT:**



COMPANY PROFILE

BROKIS represents a synthesis of exquisite design, superior quality, and the skill of master artisans continuing the centuries-old Bohemian glassmaking tradition. BROKIS lighting collections have achieved international acclaim by combining handblown glass with other refined materials, such as handcrafted wood and metal, in bold compositions that push the boundaries not only of contemporary lighting design but also of the technologies applied in production. The Czech family-run premium brand works with select designers from around the world. BROKIS is situated approximately 140 kilometres southeast of Prague in the village of Janštejn and operates its own glassworks backed by more than 200 years of tradition. The company exports its products to more than 120 countries throughout the world. Each BROKIS light is a genuine handmade original, a functional work of art as captivating by day as it is by night.



PRESENTATION

SUSTAINABILITY REPORT

In addition to actively practicing ecological sustainability, we're a socially responsible and ethical company. We value the knowhow of our master glassblowers, whose dedication and hard work keeps the glassblowing tradition going from one generation to the next. Our company is a leader in sustainability, not only because we achieve significant energy savings but also thanks to our track record of extending the lifetime of products, reducing hazardous substances, and collecting and recycling waste materials. BROKISGLASS material, arose from the ecological manufacturing practices of Janštejn Glassworks and BROKIS. Collaboration between these two enterprises has led to the creation of a unique new material made of glass shards. The glassworks upcycle not only the shards for BROKISGLASS panels, but also glass dust and sand, which is used for concrete and then applied in our lighting collections.



PRESENTATION

CONTACT:

tel.: +420 567 211 517
email: info@brokis.cz

BROKIS
Španielova 1315/25, Praha 6, 163 00
Czech Republic

ID: 64940799
VAT: CZ64940799

www.brokis.cz



TRIMLESS CEILING CONNECTION

TRIMLESS is a new solution for BROKIS collections that eliminates the need for a conventional ceiling canopy and simplifies installation in drywall ceilings. It gives ceiling installations a clean, minimalistic appearance and provides a new degree of variability in creating original lighting compositions.



MORE INFO



TRIMLESS



BROKIS CONNECTOR - CLICK&SAFE

It offers a remarkable degree of variability and near endless possibilities for creating unique interior lighting compositions. The BROKIS connector has been gradually implemented in the majority of the brand's collections and has proven a valuable addition to the product portfolio.



MORE INFO



CLICK&SAFE



CEILING CANOPIES

BROKIS collections offer various sets that make use of atypical ceiling canopies. The sets are prepared by the designers and provide clients with ready lighting compositions that are a good fit for their interior. The ceiling canopies facilitate installation of both large and small sets of lights and minimize the need for modifications to the ceiling prior to installation. BROKIS also offers ceiling canopies fitted with LEDs, which accentuate the lighting in the interior and amplify the visual experience of the unique designs.



MORE INFO



LED CANOPY



DIMMING SYSTEMS

The quality of the visual experience produced by BROKIS lights can be enhanced with the use of various dimming systems. BROKIS offers several dimming options for its lights that bring the user greater convenience and open the door to a broader spectrum of possibilities for achieving the right ambience.



MORE INFO

CONTACT:

tel.: +420 567 211 517
email: info@brokis.cz

BROKIS
Španielova 1315/25, Praha 6, 163 00
Czech Republic

ID: 64940799
VAT: CZ64940799

www.brokis.cz



DOWNLOAD
SHARE

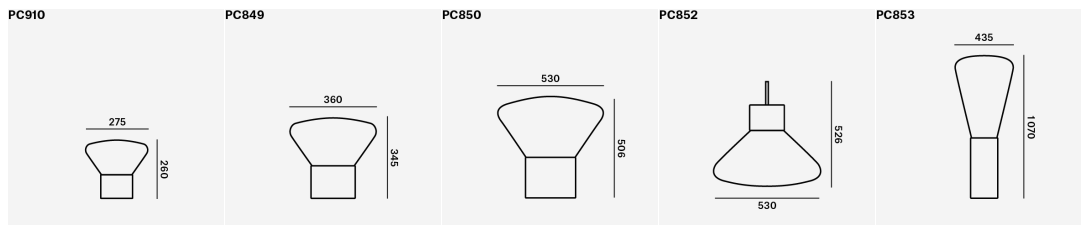

PC	PC910	PC849	PC850	PC852	PC853
NAME	MINI WOOD 06	WOOD 01	WOOD 02	WOOD 03A	WOOD 04
PRICE A	888	1 128	1 740	1 207	2 633
PRICE B	964	1 207	1 891	1 310	2 878
PRICE C	1 076	1 458	2 435	1 534	3 671
PRICE D	-	2 297	3 216	-	-

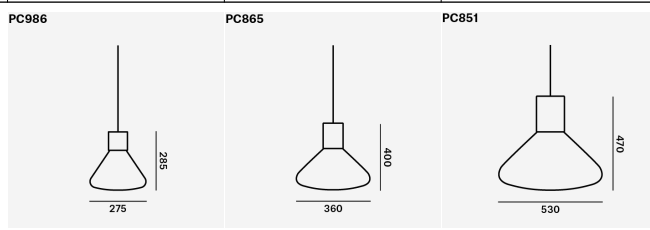

PC	PC986	PC865	PC851
NAME	WOOD 07	WOOD 05P	WOOD 03B
PRICE A	820	1 116	1 223
PRICE B	896	1 198	1 336
PRICE C	1 013	1 265	1 552
PRICE D	-	-	-
SURCHARGES (NET)			
EXTRA CABLE UP TO 5M	+ 43	+ 43	+ 43
CASAMBI	+ 78	+ 78	+ 78

IMPORTANT:

PRICE CATEGORY IS DETERMINED BY THE VERSION OF THE BASE.
IF THE GLASS FROM THE SPECIAL ANNIVERSARY EDITION IS SELECTED (AUBERGINE, OLIVE GREEN, SUNSET PINK), THE PRICE OF LIGHT IS EQUIVALENT TO THE PRICE CATEGORY C, REGARDLESS THE VERSION OF THE BASE MATERIAL.
TABLE AND FLOOR LAMPS ARE EQUIPPED WITH A HAND DIMMER.

TECHNICAL DETAILS:

GLASS COLOUR

- transparent glass (CGC23)
- smoke grey - transparent glass (CGC516)
- smoke brown - transparent glass (CGC538)
- opaline - transparent glass (CGC38)
- triplex opal (CGC39)
- amber - transparent glass (CGC515)
- cognac - transparent glass (CGC540)
- violet - transparent glass (CGC554)
- aubergine - transparent glass (CGC2753)
- olive green - transparent (CGC2738)
- sunset pink - transparent glass (CGC2752)

GLASS SURFACE

- glossy surface (CGSU66)

BASE

- A European oak - untreated (CCS657)
- European oak - clear nano coat (CCS972)
- European oak - natural lacquer (wax) (CCS518)

- B European oak - stained black (CCS592)
- European oak - stained white (CCS680)
- C American walnut - natural waxed (CCS757)
- D satinated grigio talami marble (CCS2740)
- satinated rosso francia marble (CCS2742)

CANOPY

- A European oak - untreated (CCSC840)
- European oak - clear nano coat (CCSC976)
- European oak - natural lacquer (wax) (CCSC841)
- B European oak - stained black (CCSC839)
- European oak - stained white (CCSC838)
- C American walnut - natural waxed (CCSC842)

CABLE COLOUR

- textile cable - black (CECL519)
- textile cable - white (CECL521)
- textile cable - dark grey (CECL520)

- textile cable - light grey (CECL1918)
- textile cable - red (CECL530)
- textile cable - yellow (CECL606)

RECOMMENDED BULBS

- 230V, LED, E27, 5W, 2200K, 400lm, RA90, 360°, DIM (CEB1809) (PC849, PC850, PC851, PC852, PC853, PC865)
- 230V, LED, E14, 3W, 2200K, 260lm, RA90, 360°, DIM (CEB1806) (PC910, PC986)

DIMMABLE VERSION

- TRIAC - STANDARD OPTION (CEDV2865) (PC851, PC865, PC986)
- CASAMBI CBU-TED (CEDV2855) (PC851, PC865, PC986)

SOCKET

- E27 (PC849, PC850, PC851, PC852, PC853, PC865)
- E14 (PC910, PC986)

[BACK TO INDEX](#)

Download:

- WWW
- MORE INFO.
- PHOTOS
- INSTALLATION MANUAL
- DATASHEETS
- 3DS
- DWG
- SKETCH UP
- LDT



MUFFINS CANDLEHOLDER

ACCESSORIES

Lucie Koldova & Dan Yeffet / 2018

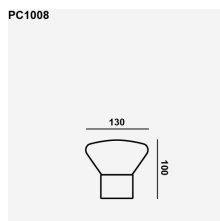
OVERSEAS EUR
SRP (Suggested Retail Price) VAT Excl.DOWNLOAD
SHARE

PC	PC1008
NAME	CANDLEHOLDER
PRICE A	94
PRICE B	118
PRICE C	-

IMPORTANT:

PRICE CATEGORY IS DETERMINED BY THE VERSION OF THE WOODEN PARTS.
THE MUFFINS CANDLEHOLDER IS SOLD IN MULTIPLES OF 8. MINIMUM ORDER QUANTITY PER COLOUR - 8 PIECES.

TECHNICAL DETAILS:**GLASS COLOUR**

transparent glass (CGC23)
smoke grey - transparent glass (CGC516)
smoke brown - transparent glass (CGC538)
opaline - transparent glass (CGC38)
amber - transparent glass (CGC515)

cognac - transparent glass (CGC540)
violet - transparent glass (CGC554)
orange - transparent glass (CGC157)
light pink - transparent glass (CGC46)

BASE

A European oak - clear nano coat (CCS972)
European oak - stained black (CCS592)
B American walnut - natural waxed (CCS757)

[BACK TO INDEX](#)**Download:**[WWW](#)[MORE INFO.](#)[PHOTOS](#)[INSTALLATION MANUAL](#)[DATASHEETS](#)[3DS](#)[DWG](#)[SKETCH UP](#)[LDT](#)

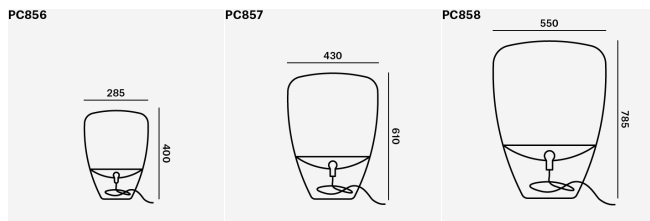
DOWNLOAD
SHARE

PC	PC856	PC857	PC858
NAME	SMALL	MEDIUM	LARGE
PRICE A	1 060	1 478	2 236
PRICE B	1 396	1 733	2 671
PRICE C	1 414	1 811	2 789

IMPORTANT:

PRICE CATEGORY IS DETERMINED BY THE VERSION OF THE REFLECTOR.
TABLE AND FLOOR LAMPS ARE EQUIPPED WITH A HAND DIMMER.

TECHNICAL DETAILS:**GLASS COLOUR**

transparent glass (CGC23)
smoke grey - transparent glass (CGC516)
smoke brown - transparent glass (CGC538)

GLASS SURFACE

glossy surface (CGSU66)

REFLECTOR

A metal - black matte powder coating (CCS846)
metal - white matte powder coating (CCS845)
lemon yellow (CCS613)
reflective orange (CCS574)

B copper (CCS584)
brass (CCS69)

C chrome (CCS275)
black chrome lacquer (CCS959)
chrome brushed (CCS960)

CABLE COLOUR

textile cable - black (CECL519)
textile cable - white (CECL521)
textile cable - dark grey (CECL520)
textile cable - light grey (CECL1918)
textile cable - red (CECL530)

textile cable - yellow (CECL606)

RECOMMENDED BULBS

230V, LED, E14, 3W, 2200K, 260lm, RA90, 360°, DIM
(CEB1806) (PC856)
230V, LED, E27, 5W, 2200K, 400lm, RA90, 360°, DIM
(CEB1810) (PC857, PC858)

SOCKET

E27 (PC857, PC858)
E14 (PC856)

BACK TO INDEX

Download:

WWW

MORE INFO.

PHOTOS

INSTALLATION MANUAL

DATASHEETS

3DS

DWG

SKETCH UP

LDT





DOWNLOAD
SHARE

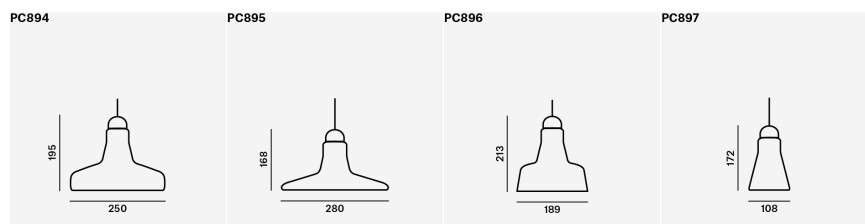

PC	PC894	PC895	PC896	PC897
NAME	SHADOWS	SHADOWS	SHADOWS	SHADOWS
PRICE A	526	550	505	469
PRICE B	580	599	556	523
PRICE C	-	-	-	-
SURCHARGES (NET)				
EXTRA CABLE UP TO 5M	+ 36	+ 36	+ 36	+ 36
TRIMLESS	+ 120	+ 120	+ 120	+ 120
CASAMBI	+ 78	+ 78	+ 78	+ 78

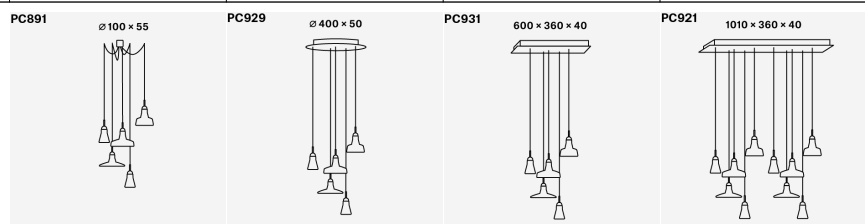

PC	PC891	PC929	PC931	PC921
NAME	SET FREE	SET RING CANOPY	SET RECTANGULAR CANOPY SMALL	SET RECTANGULAR CANOPY LARGE
PRICE A	2 312	2 404	2 404	4 396
PRICE B	2 542	2 585	2 585	4 757
PRICE C	-	-	-	-
SURCHARGES (NET)				
EXTRA CABLE UP TO 5M	+ 144	+ 144	+ 144	+ 288
CASAMBI	+ 78	+ 78	+ 78	+ 78

IMPORTANT:

PRICE CATEGORY IS DETERMINED BY THE VERSION OF THE WOODEN PARTS.
BLACK OPAQUE GLASS IS IDENTICAL TO THE PREVIOUS BLACK TRANSPARENT. THE NAME HAS BEEN MADE MORE SPECIFIC, SINCE THE GLASS IS NOT TRANSPARENT.

TECHNICAL DETAILS:

GLASS COLOUR

- transparent glass (CGC23)
- smoke grey - transparent glass (CGC516)
- smoke brown - transparent glass (CGC538)
- opaline - transparent glass (CGC38)
- triplex opal (CGC39)
- black opaque (CGC2933)
- pearl grey - opaline glass (CGC1916)

GLASS SURFACE

- glossy surface (CGSU66)
- acid-etched outside surface (CGSU67)

LIGHT BODY

- A** European oak - untreated (CCS657)
 - European oak - clear nano coat (CCS972)
 - European oak - natural lacquer (wax) (CCS518)
 - European oak - stained black (CCS592)
 - European oak - stained white (CCS680)
- B** American walnut - natural waxed (CCS757)

CANOPY

- A** European oak - untreated (CCSC840) (PC891, PC894, PC895, PC896, PC897)
 - European oak - clear nano coat (CCSC976) (PC891, PC894, PC895, PC896, PC897)
 - European oak - natural lacquer (wax) (CCSC841) (PC891, PC894, PC895, PC896, PC897)
 - European oak - stained black (CCSC839) (PC891, PC894, PC895, PC896, PC897)
 - European oak - stained white (CCSC838) (PC891, PC894, PC895, PC896, PC897)
 - metal - black matte powder coating (CCSC619) (PC921, PC929, PC931)
 - metal - white matte powder coating (CCSC618) (PC921, PC929, PC931)
 - B** American walnut - natural waxed (CCSC842) (PC891, PC894, PC895, PC896, PC897)
- Trimless - cable version - white structure (CCSC2903) (PC894, PC895, PC896, PC897)
Trimless - cable version - black structure (CCSC2904) (PC894, PC895, PC896, PC897)

CONNECTION METHOD

BROKIS connector 230V (CCM2876)

CABLE COLOUR

- textile cable - black (CECL519)
- textile cable - white (CECL521)
- textile cable - light grey (CECL1918)
- textile cable - dark grey (CECL520)
- textile cable - red (CECL530)
- textile cable - yellow (CECL606)

RECOMMENDED BULBS

230V, GU10, 5W, 2700K, 336lm, RA90, 60°, DIM (CEB373)

DIMMABLE VERSION

TRIAC - STANDARD OPTION (CEDV2865)
CASAMBI CBU-TED (CEDV2855)

SOCKET

GZ10 (PC894, PC895, PC896, PC897)
5 x GZ10 (PC891, PC929, PC931)
10 x GZ10 (PC921)

[BACK TO INDEX](#)

Download:

- [WWW](#)
- [MORE INFO.](#)
- [PHOTOS](#)
- [INSTALLATION MANUAL](#)
- [DATASHEETS](#)
- [3DS](#)
- [DWG](#)
- [SKETCH UP](#)
- [LDT](#)





DOWNLOAD
SHARE

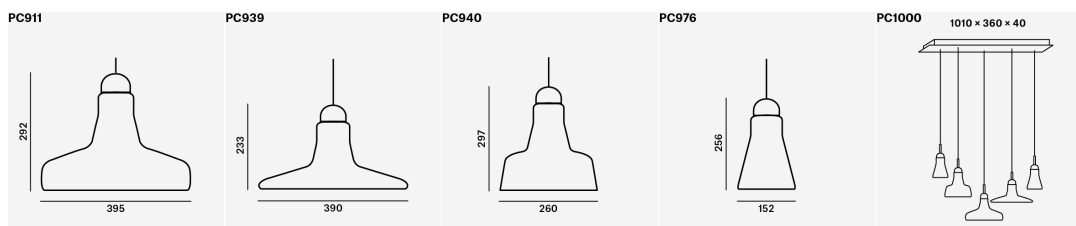

PC	PC911	PC939	PC940	PC976	PC1000
NAME	XL	XL	XL	XL	XL SET RECTANGULAR CANOPY LARGE
PRICE A	942	942	865	779	3 818
PRICE B	1 042	1 042	966	880	4 032
PRICE C	-	-	-	-	-
SURCHARGES (NET)					
EXTRA CABLE UP TO 5M	+ 36	+ 36	+ 36	+ 36	+ 144
TRIMLESS	+ 120	+ 120	+ 120	+ 120	-
CASAMBI	+ 78	+ 78	+ 78	+ 78	+ 78

IMPORTANT:

PRICE CATEGORY IS DETERMINED BY THE VERSION OF THE WOODEN PARTS.
BLACK OPAQUE GLASS IS IDENTICAL TO THE PREVIOUS BLACK TRANSPARENT. THE NAME HAS BEEN MADE MORE SPECIFIC, SINCE THE GLASS IS NOT TRANSPARENT.

TECHNICAL DETAILS:

GLASS COLOUR

- transparent glass (CGC23)
- smoke grey - transparent glass (CGC516)
- smoke brown - transparent glass (CGC538)
- opaline - transparent glass (CGC38)
- triplex opal (CGC39)
- black opaque (CGC2933)
- pearl grey - opaline glass (CGC1916)

GLASS SURFACE

- glossy surface (CGSU66)
- acid-etched outside surface (CGSU67)

LIGHT BODY

- A** European oak - untreated (CCS657)
- European oak - clear nano coat (CCS972)
- European oak - natural lacquer (wax) (CCS518)
- European oak - stained black (CCS592)
- European oak - stained white (CCS680)
- B** American walnut - natural waxed (CCS757)

CANOPY

- A** metal - black matte powder coating (CCSC619) (PC1000)
- metal - white matte powder coating (CCSC618) (PC1000)
- European oak - untreated (CCSC840) (PC911, PC939, PC940, PC976)
- European oak - clear nano coat (CCSC976) (PC911, PC939, PC940, PC976)
- European oak - natural lacquer (wax) (CCSC841) (PC911, PC939, PC940, PC976)
- European oak - stained black (CCSC839) (PC911, PC939, PC940, PC976)
- European oak - stained white (CCSC838) (PC911, PC939, PC940, PC976)
- B** American walnut - natural waxed (CCSC842) (PC911, PC939, PC940, PC976)
- Trimless - cable version - white structure (CCSC2903) (PC911, PC939, PC940, PC976)
- Trimless - cable version - black structure (CCSC2904) (PC911, PC939, PC940, PC976)

CONNECTION METHOD

BROKIS connector 230V (CCM2876)

CABLE COLOUR

- textile cable - black (CECL519)
- textile cable - white (CECL521)
- textile cable - light grey (CECL1918)
- textile cable - dark grey (CECL520)
- textile cable - red (CECL530)
- textile cable - yellow (CECL606)

RECOMMENDED BULBS

230V, E27, 13W, 2700K, 700lm, RA90, 60°, DIM (CEB621)

DIMMABLE VERSION

- TRIAC - STANDARD OPTION (CEDV2865)
- CASAMBI CBU-TED (CEDV2855)

SOCKET

E27 (PC911, PC939, PC940, PC976)
5 x E27 (PC1000)

[BACK TO INDEX](#)

Download:

- [WWW](#)
- [MORE INFO.](#)
- [PHOTOS](#)
- [INSTALLATION MANUAL](#)
- [DATASHEETS](#)
- [3DS](#)
- [DWG](#)
- [SKETCH UP](#)
- [LDT](#)

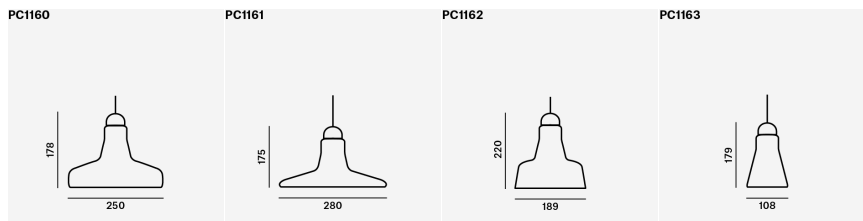

DOWNLOAD
SHARE

PC	PC1160	PC1161	PC1162	PC1163
NAME	EXTERIOR	EXTERIOR	EXTERIOR	EXTERIOR
PRICE A	750	770	734	695
PRICE B	-	-	-	-
PRICE C	-	-	-	-
SURCHARGES (NET)				
EXTRA CABLE UP TO 5M	+ 36	+ 36	+ 36	+ 36
CASAMBI	+ 78	+ 78	+ 78	+ 78

IMPORTANT:

BLACK OPAQUE GLASS IS IDENTICAL TO THE PREVIOUS BLACK TRANSPARENT. THE NAME HAS BEEN MADE MORE SPECIFIC, SINCE THE GLASS IS NOT TRANSPARENT.

TECHNICAL DETAILS:**GLASS COLOUR**

transparent glass (CGC23)
 smoke grey - transparent glass (CGC516)
 smoke brown - transparent glass (CGC538)
 opaline - transparent glass (CGC38)
 triplex opal (CGC39)
 black opaque (CGC2933)
 pearl grey - opaline glass (CGC1916)

GLASS SURFACE

glossy surface (CGSU66)
 acid-etched outside surface (CGSU67)

LIGHT BODY

silver anodized (CCS1917)
 black anodized (CCS1948)

CANOPY

brushed stainless steel (CCSC974)
 metal - black matte powder coating (CCSC619)

CONNECTION METHOD

BROKIS connector 230V (CCM2876)

CABLE COLOUR

silicone cable - black (CECL2758)

silicone cable - white (CECL2757)

RECOMMENDED BULBS

230V, LED, GU10, 6,5W, 2700K, DIM (CEB2761)

DIMMABLE VERSION

TRIAC - STANDARD OPTION (CEDV2865)
 CASAMBI CBU-TED (CEDV2855)

SOCKET

GZ10

[BACK TO INDEX](#)

Download:

[WWW](#)[MORE INFO.](#)[PHOTOS](#)[INSTALLATION MANUAL](#)[DATASHEETS](#)[3DS](#)[DWG](#)[SKETCH UP](#)[LDT](#)



DOWNLOAD
SHARE

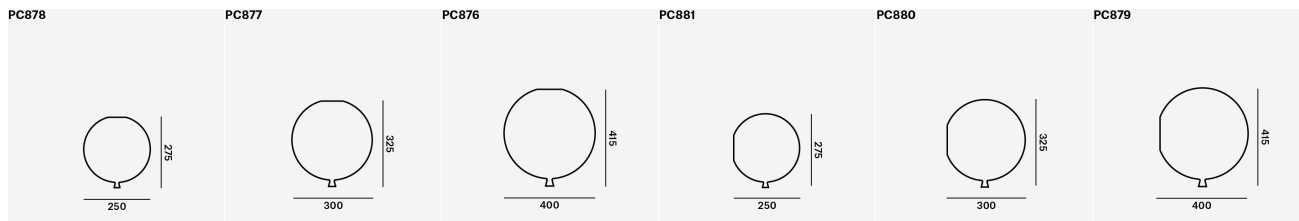

PC	PC878	PC877	PC876	PC881	PC880	PC879
NAME	CEILING 250	CEILING 300	CEILING 400	WALL 250	WALL 300	WALL 400
PRICE A	292	409	517	292	409	517
PRICE B	310	445	539	310	445	539
PRICE C	317	463	578	317	463	578

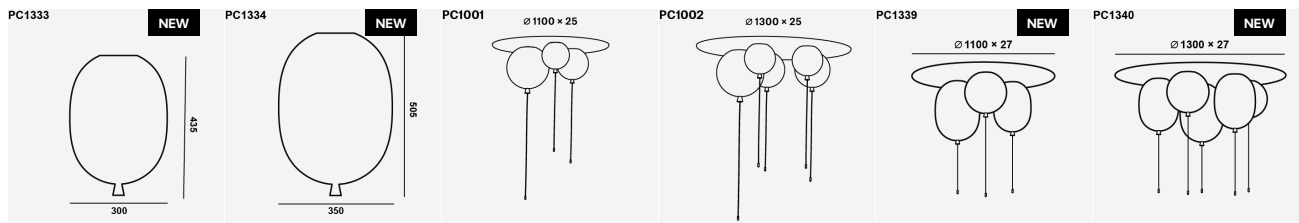

PC	PC1333	PC1334	PC1001	PC1002	PC1339	PC1340
NAME	CEILING OVAL 300	CEILING OVAL 350	SET S	SET L	SET S OVAL	SET L OVAL
PRICE A	470	517	-	-	-	-
PRICE B	511	539	1 913	2 807	2 034	3 180
PRICE C	533	578	-	-	-	-

IMPORTANT:

PRICE CATEGORY IS DETERMINED BY THE COLOUR OF THE GLASS.
SETS ARE COMPLETELY IN PRICE CATEGORY B REGARDLESS OF GLASS COLOUR.
BULB IS NOT INCLUDED.
STANDARD LENGTH OF THE CORD IS 120CM.
MEMORY SET PC1001 CONSISTS OF 1x PC878, 1x PC877 and 1x PC876.
MEMORY SET PC1002 CONSISTS OF 2x PC878, 2x PC877 and 1x PC876.
MEMORY SET OVAL PC1339 CONSISTS OF 1x PC877, 1x PC1333 and 1x PC1334.
MEMORY SET OVAL PC1340 CONSISTS OF 2x PC877, 2x PC1333 and 1x PC1334.
MEMORY SET CAN BE ORDERED IN ANY COLOR.
MEMORY 10TH ANNIVERSARY COLLECTION HAS NEW GLASS COLOUR OPTIONS: BROWN TRIPLEX-OPAL AND AMBER TRIPLEX-OPAL.

TECHNICAL DETAILS:

GLASS COLOUR

- A** triplex opal (CGC39)
- B** grey - triplex opal (CGC617)
brown - triplex opal (CGC2896)
amber - triplex opal (CGC2897)
- C** light pink - triplex opal (CGC30)
red - triplex opal (CGC579)
orange - triplex opal (CGC580)
yellow - triplex opal (CGC47)
green apple - triplex opal (CGC578)
turquoise - triplex opal (CGC601)

blue - triplex opal (CGC28)

GLASS SURFACE

- glossy surface (CGSU66)
- acid-etched both side surface (CGSU881)

BODY FINISH

iron chromate - silver (CCS620)

CANOPY

MDF canopy - white (CCSC887) (PC1001, PC1002, PC1339, PC1340)

ENDING PART AND CORD

- light switch - black (CEE778)
- light switch - white (CEE777)

SOCKET

- E27 (PC1333, PC1334, PC876, PC877, PC878, PC879, PC880, PC881)
- 5 x E27 (PC1002, PC1340)
- 3 x E27 (PC1001, PC1339)

[BACK TO INDEX](#)

Download:

- [WWW](#)
- [MORE INFO.](#)
- [PHOTOS](#)
- [INSTALLATION MANUAL](#)
- [DATASHEETS](#)
- [3DS](#)
- [DWG](#)
- [SKETCH UP](#)
- [LDT](#)

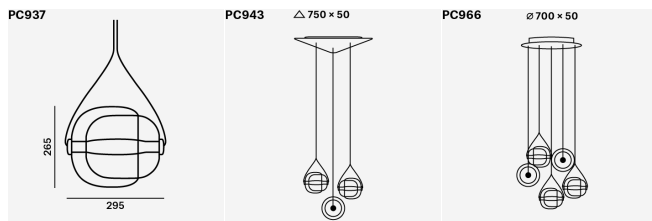

DOWNLOAD
SHARE

PC	PC937	PC943	PC966
NAME	SINGLE	TRIANGLE	METAL CANOPY
PRICE A	1 902	5 658	8 128
PRICE B	-	-	-
PRICE C	-	-	-
SURCHARGES (NET)			
EXTRA CABLE UP TO 5M	+ 58	+ 173	+ 288
DIM	+ 54	+ 54	+ 54

IMPORTANT:

THE PRICE OF THE LIGHT APPLIES TO THE NON-DIMMABLE VERSION. FOR THE DIMMABLE VERSIONS DIM OR DIM (TW) TUNABLE WHITE, A SURCHARGE WILL APPLY. TUNABLE WHITE IS AVAILABLE IN SELECTED COLLECTIONS ONLY.

TECHNICAL DETAILS:**COLOUR OF THE OUTSIDE GLASS**

transparent glass (CGC23)
smoke grey - transparent glass (CGC516)
opaline - transparent glass (CGC38)
amber - transparent glass (CGC515)
yellow - transparent glass (CGC659)
violet - transparent glass (CGC554)
red - transparent glass (CGC45)
light blue - transparent glass (CGC544)
orange - transparent glass (CGC157)
pearl grey - opaline glass (CGC1916)

GLASS SURFACE OF THE OUTSIDE GLASS

glossy surface (CGSU66)
acid-etched both side surface (CGSU881)

COLOUR OF THE INNER GLASS

transparent glass (CGCl682)
smoke grey - transparent glass (CGCl685)
opaline - transparent glass (CGCl749)
amber - transparent glass (CGCl686)
yellow - transparent glass (CGCl681)

violet - transparent glass (CGCl683)
red - transparent glass (CGCl913)
light blue - transparent glass (CGCl912)
orange - transparent glass (CGCl938)
pearl grey - opaline glass (CGCl914)

GLASS SURFACE OF THE INNER GLASS

acid-etched both side surface (CGSUI905)
glossy surface (CGSUI906)

BODY FINISH

black anodized (CCS1948)
silver anodized (CCS1917)

CANOPY

metal - black matte powder coating (CCSC619)
metal - white matte powder coating (CCSC618)

CONNECTION METHOD

BROKIS connector 24V (CCM1019)

CABLE COLOUR

textile cable - black (CECL519)
textile cable - light grey (CECL1918)

LED SOURCE

24V, LED, 7.5W, 2700K, 318lm, RA90+, DIM (LEDS1945)
24V, LED, 7.5W, 4000K, 352lm, RA90+, DIM (LEDS1946)
24V, LED, 7.5W, 5000K, 377lm, RA90+, DIM (LEDS1947)

DIMMABLE VERSION

non-dimmable version (CEDV1457)
DIM RF system - remote control version (CEDV1461)
DIM PWM signal (CEDV1459)
DIM 1-10V (CEDV1460)
DIM DALI version (CEDV1458)
DIM AC phase-cut (CEDV1730)
DIM CASAMBI CBU-PWM4 (CEDV2854)

VOLTAGE/FREQUENCY

100-240VAC,50/60Hz, 8W LED (PC937)
100-240VAC,50/60Hz, 40W LED (PC966)
100-240VAC,50/60Hz, 22W LED (PC943)

[BACK TO INDEX](#)

Download:

[WWW](#) [MORE INFO.](#) [PHOTOS](#) [INSTALLATION MANUAL](#) [DATASHEETS](#) [3DS](#) [DWG](#) [SKETCH UP](#) [LDT](#)



FAQ





DOWNLOAD
SHARE

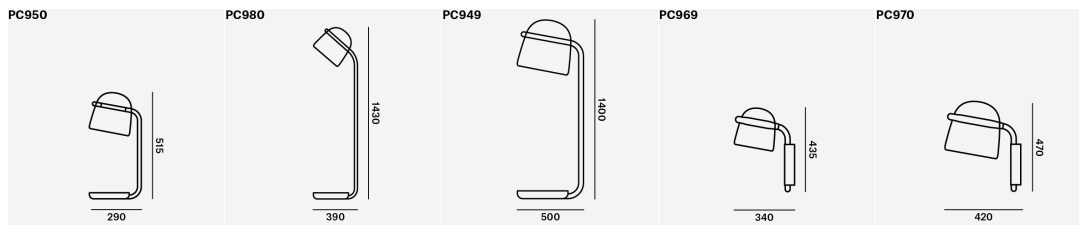

PC	PC950	PC980	PC949	PC969	PC970
NAME	SMALL TABLE	MEDIUM FLOOR	LARGE FLOOR	SMALL WALL	MEDIUM WALL
PRICE A	2 335	4 003	4 663	1 788	2 038
SURCHARGES (NET)					
DIM	+ 54	+ 54	+ 54	-	-

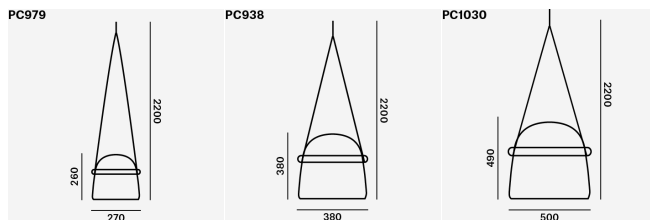

PC	PC979	PC938	PC1030
NAME	MEDIUM PENDENT	LARGE PENDENT	XL PENDENT
PRICE A	1 840	2 179	4 218
SURCHARGES (NET)			
STRAPS FOR 1M EXTRA	+ 100	+ 113	+ 130
DIM	+ 54	+ 54	+ 54

IMPORTANT:

THE PRICE OF THE LIGHT APPLIES TO THE NON-DIMMABLE VERSION. FOR THE DIMMABLE VERSIONS DIM OR DIM (TW) TUNABLE WHITE, A SURCHARGE WILL APPLY. TUNABLE WHITE IS AVAILABLE IN SELECTED COLLECTIONS ONLY.
 A CONNECTOR HAS BEEN IMPLEMENTED ACROSS THE COLLECTION AND THE WOODEN COMPONENTS REPLACED WITH METAL ONES. THESE CHANGES BRING SIGNIFICANT TECHNOLOGICAL IMPROVEMENTS, SUCH AS EASY MAINTENANCE AND QUICK REPLACEMENT OF THE LIGHT SOURCE AND GLASS.
 THE MONA SMALL TABLE LIGHT CAN BE DIMMED BY TOUCHING ANY PART OF THE METAL BODY.
 THE MONA WALL CAN BE ADJUSTED USING A ROTARY DIMMER INTEGRATED INTO THE BOTTOM OF THE METAL BODY.
 FOR MONA PENDENT THE CLIENT MUST SPECIFY THE EXACT DROPLENGTH (FROM THE CEILING TO THE BOTTOM PART OF THE LIGHT) WHEN PLACING AN ORDER.
 THE MONA COLLECTION NOW OFFERS GLASS IN A BROWN SMOKE VARIANT.

TECHNICAL DETAILS:

GLASS COLOUR

- transparent glass (CGC23)
- smoke grey - transparent glass (CGC516)
- smoke brown - transparent glass (CGC538)
- opaline - transparent glass (CGC38)
- black - transparent glass (CGC602)
- violet - transparent glass (CGC554)

GLASS SURFACE

- glossy surface (CGSU66)

BODY FINISH

- metal - black matte powder coating (CCS846) (PC950, PC969, PC970, PC980, PC949)
- metal - white matte powder coating (CCS845) (PC950, PC969, PC970, PC979, PC980, PC938, PC949, PC1030)
- silver anodized (CCS1917) (PC979, PC938, PC1030)
- black anodized (CCS1948) (PC979, PC938, PC1030)

CANOPY

- metal - black matte powder coating (CCSC619)
- metal - white matte powder coating (CCSC618)

CONNECTION METHOD

BROKIS connector 24V (CCM1019)

STRAPS

- leather straps - black (GINT792)
- leather straps - natural (GINT788)
- leather straps - grey (GINT758)
- leather straps - dark brown (GINT793)

CABLE COLOUR

- textile cable - black (CECL519)
- textile cable - white (CECL521)

LED SOURCE

- 24V, LED, 2.5W, 2700K, 106lm, RA90+, DIM (LEDS1986)
- 24V, LED, 2.5W, 4000K, 117lm, RA90+, DIM (LEDS1987)
- 24V, LED, 2.5W, 5000K, 125lm, RA90+, DIM (LEDS1988)
- 24V, LED, 7.7W, 2700K, 327lm, RA90+, DIM (LEDS1989)
- 24V, LED, 7.7W, 4000K, 360lm, RA90+, DIM (LEDS1990)
- 24V, LED, 7.7W, 5000K, 387lm, RA90+, DIM (LEDS1991)
- 24V, LED, 13W, 2700K, 550lm, RA90+, DIM (LEDS1992)
- 24V, LED, 13W, 4000K, 610lm, RA90+, DIM (LEDS1993)
- 24V, LED, 13W, 5000K, 654lm, RA90+, DIM (LEDS1994)
- 24V, LED, 18W, 2700K, 765lm, RA90+, DIM (LEDS1922)

- 24V, LED, 18W, 4000K, 846lm, RA90+, DIM (LEDS2149)
- 24V, LED, 18W, 5000K, 906lm, RA90+, DIM (LEDS2150)

DIMMABLE VERSION

- integrated dimmer on the base of the light (CEDV1462) (PC950)
- DIM CASAMBI CBU-PWM4 (CEDV2854) (PC950, PC979, PC980, PC938, PC949, PC1030)
- integrated dimmer on the body of the light (CEDV1463) (PC969, PC970)
- non-dimmable version (CEDV1457) (PC979, PC980, PC938, PC949, PC1030)
- DIM RF system - remote control version (CEDV1461) (PC979, PC980, PC938, PC949, PC1030)
- DIM PWM signal (CEDV1459) (PC979, PC938, PC1030)
- DIM 1-10V (CEDV1460) (PC979, PC938, PC1030)
- DIM DALI version (CEDV1458) (PC979, PC938, PC1030)
- DIM AC phase-cut (CEDV1730) (PC979, PC938, PC1030)

VOLTAGE/FREQUENCY

- 100-240VAC, 50/60Hz, 7.7W LED (PC970, PC979, PC980)
- 100-240VAC, 50/60Hz, 2.5W LED (PC950, PC969)
- 100-240VAC, 50/60Hz, 18W LED (PC1030)
- 100-240VAC, 50/60Hz, 13W LED (PC938, PC949)

[BACK TO INDEX](#)

Download:

- [WWW](#)
- [MORE INFO.](#)
- [PHOTOS](#)
- [INSTALLATION MANUAL](#)
- [DATASHEETS](#)
- [3DS](#)
- [DWG](#)
- [SKETCH UP](#)
- [LDT](#)

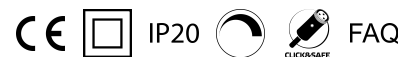

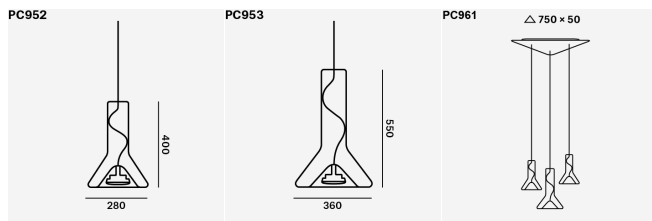
DOWNLOAD
SHARE

PC	PC952	PC953	PC961
NAME	SMALL	MEDIUM	SET SSM
PRICE A	1 266	1 547	3 935
PRICE B	-	-	-
PRICE C	1 547	1 824	4 651
SURCHARGES (NET)			
EXTRA CABLE UP TO 5M	+ 36	+ 36	+ 101
TRIMLESS	+ 120	+ 120	-
CASAMBI	+ 78	+ 78	+ 78

IMPORTANT:

PRICE CATEGORY IS DETERMINED BY THE VERSION OF THE METAL PARTS.

TECHNICAL DETAILS:**GLASS COLOUR**

transparent glass (CGC23)
 smoke grey - transparent glass (CGC516)
 smoke brown - transparent glass (CGC538)
 opaline - transparent glass (CGC38)

GLASS SURFACE

glossy surface (CGSU66)

REFLECTOR

A metal - black matte powder coating (CCS846)
 metal - white matte powder coating (CCS845)
 grey (CCS720)
 magenta (CCS724)
 menthol (CCS723)

C copper (CCS584)
 brass (CCS69)
 chrome (CCS275)

CANOPY

A metal - black matte powder coating (CCSC619) (PC952, PC953, PC961)
 metal - white matte powder coating (CCSC618) (PC952, PC953, PC961)
 metal - grey matte powder coating (CCSC894) (PC952, PC953)
 metal - magenta matte powder coating (CCSC892) (PC952, PC953)
 metal - menthol matte powder coating (CCSC893) (PC952, PC953)

C copper (CCSC896) (PC952, PC953)
 brass (CCSC897) (PC952, PC953)
 chrome (CCSC895) (PC952, PC953)

Trimless - cable version - white structure (CCSC2903) (PC952, PC953)
 Trimless - cable version - black structure (CCSC2904) (PC952, PC953)

CONNECTION METHOD

BROKIS connector 230V (CCM2876)

CABLE COLOUR

textile cable - black (CECL519)
 textile cable - white (CECL521)
 textile cable - light grey (CECL1918)
 textile cable - dark grey (CECL520)
 textile cable - magenta (CECL726)
 textile cable - menthol (CECL725)

RECOMMENDED BULBS

230V, GX53, 10W, 2700K, 700lm, RA90, 100°, DIM (CEB717)

DIMMABLE VERSION

TRIAC - STANDARD OPTION (CEDV2865)
 CASAMBI CBU-TED (CEDV2855)

SOCKET

GX53

[BACK TO INDEX](#)

Download:

[WWW](#)[MORE INFO.](#)[PHOTOS](#)[INSTALLATION MANUAL](#)[DATASHEETS](#)[3DS](#)[DWG](#)[SKETCH UP](#)[LDT](#)

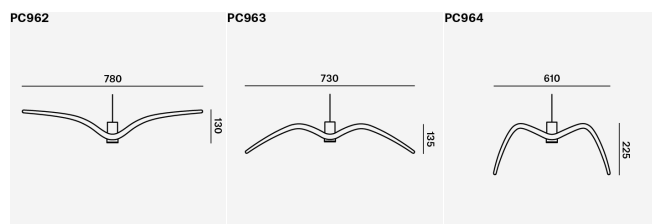
DOWNLOAD
SHARE

PC	PC962	PC963	PC964
NAME	PENDENT	PENDENT	PENDENT
PRICE A	1 075	1 056	1 141
PRICE B	-	-	-
PRICE C	-	-	-
SURCHARGES (NET)			
EXTRA CABLE UP TO 5M	+ 36	+ 36	+ 36
TRIMLESS	+ 120	+ 120	+ 120
CASAMBI	+ 78	+ 78	+ 78

IMPORTANT:

THE TRIMLESS SOLUTION CAN ONLY BE USED FOR THE INTERIOR VARIANT OF NIGHT BIRDS AND ONLY WITH THE TEXTILE POWER CABLE. THE SOLUTION IS NOT COMPATIBLE WITH THE TRANSPARENT POWER CABLE.

TECHNICAL DETAILS:**GLASS COLOUR**

opal - opaque - massif (CGC772)
 smoke grey - massif (CGC882)
 smoke grey BROKISGLASS matte (CGC1480)
 triplex opal BROKISGLASS matte (CGC1478)

BODY FINISH

silver anodized (CCS775)
 black anodized (CCS1948)

CANOPY

silver anodized (CCSC843)
 black anodized (CCSC2844)

Trimless – cable version – white structure (CCSC2903)
 Trimless – cable version – black structure (CCSC2904)

CABLE COLOUR

textile cable - black (CECL519)
 textile cable - white (CECL521)
 textile cable - light grey (CECL1918)
 transparent cable (CECL149)

RECOMMENDED BULBS

230V, GU10, 5W, 2700K, 336lm, RA90, 100°, DIM (CEB825)

DIMMABLE VERSION

TRIAC - STANDARD OPTION (CEDV2865)
 CASAMBI CBU-TED (CEDV2855)

SOCKET

GZ10

[BACK TO INDEX](#)

Download:

[WWW](#)[MORE INFO.](#)[PHOTOS](#)[INSTALATION MANUAL](#)[DATASHEETS](#)[3DS](#)[DWG](#)[SKETCH UP](#)[LDT](#)



DOWNLOAD
SHARE

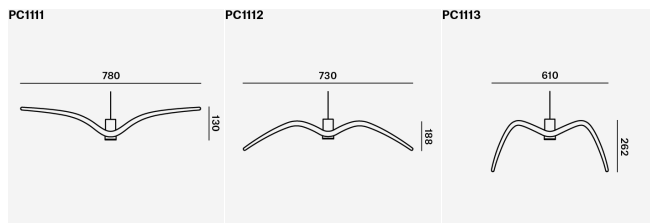

PC	PC1111	PC1112	PC1113
NAME	PENDENT EXTERIOR	PENDENT EXTERIOR	PENDENT EXTERIOR
PRICE A	1 147	1 147	1 199
PRICE B	-	-	-
PRICE C	-	-	-
SURCHARGES (NET)			
EXTRA CABLE UP TO 5M	+ 36	+ 36	+ 36
CASAMBI	+ 78	+ 78	+ 78

TECHNICAL DETAILS:

GLASS COLOUR

opal - opaque - massif (CGC772)
smoke grey - massif (CGC882)
smoke grey BROKISGLASS matte (CGC1480)
triplex opal BROKISGLASS matte (CGC1478)

LIGHT BODY

silver anodized (CCS1917)
black anodized (CCS1948)

CANOPY

brushed stainless steel (CCSC974)
metal - black matte powder coating (CCSC619)

CABLE COLOUR

silicone cable - black (CECL2758)
silicone cable - white (CECL2757)

RECOMMENDED BULBS

230V, LED, GU10, 6,5W, 2700K, DIM (CEB2761)

DIMMABLE VERSION

TRIAC - STANDARD OPTION (CEDV2865)
CASAMBI CBU-TED (CEDV2855)

SOCKET

GZ10

[BACK TO INDEX](#)

Download:

[WWW](#)

[MORE INFO.](#)

[PHOTOS](#)

[INSTALLATION MANUAL](#)

[DATASHEETS](#)

[3DS](#)

[DWG](#)

[SKETCH UP](#)

[LDT](#)

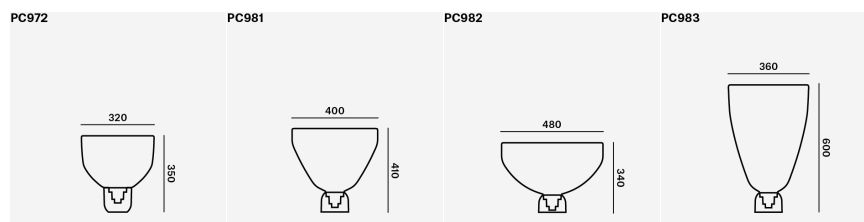

DOWNLOAD
SHARE

PC	PC972	PC981	PC982	PC983
NAME	S	M	L	L-H
PRICE A	924	1 073	1 364	1 538
PRICE B	-	-	-	-
PRICE C	-	-	-	-

IMPORTANT:

TABLE LAMPS ARE EQUIPPED WITH A HAND DIMMER.

TECHNICAL DETAILS:**COLOUR OF THE UPPER PART GLASS**

transparent glass (CGC23)
 smoke grey - transparent glass (CGC516)
 opaline - transparent glass (CGC38)
 amber - transparent glass (CGC515)
 violet - transparent glass (CGC554)
 red - transparent glass (CGC45)
 light blue - transparent glass (CGC544)
 orange - transparent glass (CGC157)
 menthol - transparent glass (CGC2184)

GLASS SURFACE OF THE UPPER PART GLASS

glossy - sandblasted (top part) (CGSU806)

COLOUR OF THE BOTTOM PART GLASS

transparent glass (CGGB812)
 dark smoke grey - transparent glass (CGGB813)

GLASS SURFACE OF THE BOTTOM PART GLASS

glossy surface (CGSUB890)
 acid-etched both side surface (CGSUB891)

CABLE COLOUR

textile cable - black (CECL519)
 textile cable - white (CECL521)
 textile cable - dark grey (CECL520)
 textile cable - light grey (CECL1918)

RECOMMENDED BULBS

230V, GU10, 5W, 2700K, 336lm, RA90, 100°, DIM (CEB825)

SOCKET

GZ10

[BACK TO INDEX](#)

Download:

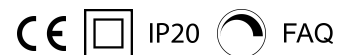
[WWW](#)[MORE INFO.](#)[PHOTOS](#)[INSTALATION MANUAL](#)[DATASHEETS](#)[3DS](#)[DWG](#)[SKETCH UP](#)[LDT](#)

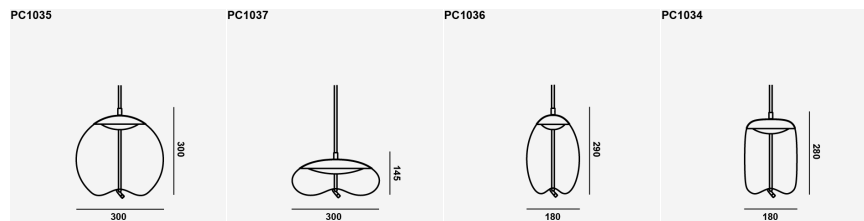
DOWNLOAD
SHARE

PC	PC1035	PC1037	PC1036	PC1034
NAME	SMALL SFERA	SMALL DISCO	SMALL UOVO	SMALL CILINDRO
PRICE A	1 721	2 015	1 576	1 702
PRICE B	-	-	-	-
PRICE C	1 816	2 125	1 662	1 795
SURCHARGES (NET)				
ROPE FOR 1M EXTRA	+ 86	+ 86	+ 86	+ 86
TRIMLESS	+ 150	+ 150	+ 150	+ 150
DIM	+ 54	+ 54	+ 54	+ 54

IMPORTANT:

THE PRICE OF THE LIGHT APPLIES TO THE NON-DIMMABLE VERSION. FOR THE DIMMABLE VERSIONS DIM OR DIM (TW) TUNABLE WHITE, A SURCHARGE WILL APPLY. TUNABLE WHITE IS AVAILABLE IN SELECTED COLLECTIONS ONLY.
PRICE CATEGORY IS DETERMINED BY THE VERSION OF THE METAL PARTS.
WITH REGARD FOR ENVIRONMENTAL FACTORS (MOISTURE, TEMPERATURE STABILITY, DUST, ETC.) AND THE ACCUMULATION OF DIRT AND SMUDGES TYPICAL FOR GLASS PRODUCTS, MAINTAINING THE OUTSTANDING APPEARANCE OF LIGHTS IN THE GLOSS GLASS VARIANT REQUIRES REGULAR CLEANING OF THE GLASS ACCORDING TO BROKIS INSTRUCTIONS.

TECHNICAL DETAILS:**GLASS COLOUR**

transparent glass (CGC23)
smoke grey - transparent glass (CGC516)
smoke brown - transparent glass (CGC538)
opaline - transparent glass (CGC38)

GLASS SURFACE

glossy surface (CGSU66)
matte inner glass finish (CGSU880)

REFLECTOR

A copper (CCS584)
brass (CCS69)
brushed stainless steel (CCS68)
metal - black matte powder coating with structure (CCS2673)
metal - white matte powder coating with structure (CCS2809)
C black chrome lacquer (CCS959)

CANOPY

A copper (CCSC896)
brass (CCSC897)
brushed stainless steel (CCSC974)
metal - black matte powder coating with structure (CCSC2674)
metal - white matte powder coating with structure (CCSC2810)
C black chrome lacquer (CCSC975)
Trimless - rope 12 mm version - white structure (CCSC2905)
Trimless - rope 12 mm version - black structure (CCSC2906)

ROPE

rope - natural (CRP970)

LED SOURCE

24V, LED, 5W, 2700K, 620lm, RA90+, DIM (LEDS1910) (PC1034)
24V, LED, 7.5W, 2700K, 954lm, RA90+, DIM (LEDS2860) (PC1035)

24V, LED, 3.4W, 2700K, 425lm, RA90+, DIM (LEDS1909) (PC1036)
24V, LED, 6.5W, 2700K, 773lm, RA90+, DIM (LEDS2861) (PC1037)

DIMMABLE VERSION

non-dimmable version (CEDV1457)
DIM RF system - remote control version (CEDV1461)
DIM PWM signal (CEDV1459)
DIM 1-10V (CEDV1460)
DIM DALI version (CEDV1458)
DIM AC phase-cut (CEDV1730)
DIM CASAMBI CBU-PWM4 (CEDV2854)

VOLTAGE/FREQUENCY

100-240VAC, 50/60Hz, 7.5W LED (PC1035)
100-240VAC, 50/60Hz, 6.5W LED (PC1037)
100-240VAC, 50/60Hz, 5W LED (PC1034)
100-240VAC, 50/60Hz, 3.4W LED (PC1036)

[BACK TO INDEX](#)

Download:

[WWW](#)[MORE INFO.](#)[PHOTOS](#)[INSTALLATION MANUAL](#)[DATASHEETS](#)[3DS](#)[DWG](#)[SKETCH UP](#)[LDT](#)

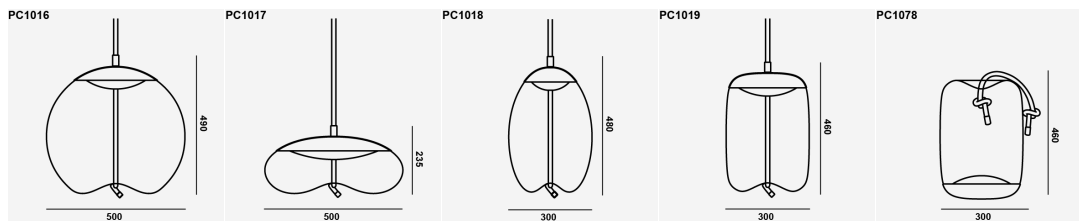
DOWNLOAD
SHARE

PC	PC1016	PC1017	PC1018	PC1019	PC1078
NAME	SFERA	DISCO	UOVO	CILINDRO	CILINDRO TABLE
PRICE A	2 362	2 639	1 752	1 974	1 910
PRICE B	-	-	-	-	-
PRICE C	2 491	2 784	1 849	2 083	1 998
SURCHARGES (NET)					
ROPE FOR 1M EXTRA	+ 108	+ 108	+ 108	+ 108	-
TRIMLESS	+ 156	+ 156	+ 156	+ 156	-
DIM	+ 54	+ 54	+ 54	+ 54	-

IMPORTANT:

THE PRICE OF THE LIGHT APPLIES TO THE NON-DIMMABLE VERSION. FOR THE DIMMABLE VERSIONS DIM OR DIM (TW) TUNABLE WHITE, A SURCHARGE WILL APPLY. TUNABLE WHITE IS AVAILABLE IN SELECTED COLLECTIONS ONLY.
PRICE CATEGORY IS DETERMINED BY THE VERSION OF THE METAL PARTS.
WITH REGARD FOR ENVIRONMENTAL FACTORS (MOISTURE, TEMPERATURE STABILITY, DUST, ETC.) AND THE ACCUMULATION OF DIRT AND SMUDGES TYPICAL FOR GLASS PRODUCTS, MAINTAINING THE OUTSTANDING APPEARANCE OF LIGHTS IN THE GLOSS GLASS VARIANT REQUIRES REGULAR CLEANING OF THE GLASS ACCORDING TO BROKIS INSTRUCTIONS.

TECHNICAL DETAILS:**GLASS COLOUR**

transparent glass (CGC23)
smoke grey - transparent glass (CGC516)
smoke brown - transparent glass (CGC538)
opaline - transparent glass (CGC38)

GLASS SURFACE

glossy surface (CGSU66)
matte inner glass finish (CGSU880)

REFLECTOR

A copper (CCS584)
brass (CCS69)
brushed stainless steel (CCS68)
metal - black matte powder coating with structure (CCS2673)
metal - white matte powder coating with structure (CCS2809)

C black chrome lacquer (CCS959)

CANOPY

A copper (CCSC896)

brass (CCSC897)
brushed stainless steel (CCSC974)
metal - black matte powder coating with structure (CCSC2674)
metal - white matte powder coating with structure (CCSC2810)

C black chrome lacquer (CCSC975)

Trimless - rope 16 mm version - white structure (CCSC2907)
Trimless - rope 16 mm version - black structure (CCSC2908)

CABLE COLOUR

textile cable - black (CECL519) (PC1078)
textile cable - light grey (CECL1918) (PC1078)

ROPE

rope - natural (CRP970)

LED SOURCE

24V, LED, 11W, 2700K, 1462lm, RA90+, DIM (LEDS2862) (PC1016)
24V, LED, 21.6W, 2700K, 2925lm, RA90+, DIM (LEDS2858)

(PC1017)
24V, LED, 3.9W, 2700K, 477lm, RA90+, DIM (LEDS981)
(PC1018)
24V, LED, 8.9W, 2700K, 1170lm, RA90+, DIM (LEDS2859) (PC1019, PC1078)

DIMMABLE VERSION

non-dimmable version (CEDV1457)
DIM RF system - remote control version (CEDV1461)
DIM PWM signal (CEDV1459)
DIM 1-10V (CEDV1460)
DIM DALI version (CEDV1458)
DIM AC phase-cut (CEDV1730)
DIM CASAMBI CBU-PWM4 (CEDV2854)

VOLTAGE/FREQUENCY

100-240VAC, 50/60Hz, 9W LED (PC1019)
100-240VAC, 50/60Hz, 4W LED (PC1018)
100-240VAC, 50/60Hz, 21.6W LED (PC1017)
100-240VAC, 50/60Hz, 11W LED (PC1016)
100-240 VAC, 50/60Hz, 9W LED (PC1078)

BACK TO INDEX

Download:

WWW

MORE INFO.

PHOTOS

INSTALLATION MANUAL

DATASHEETS

3DS

DWG

SKETCH UP

LDT

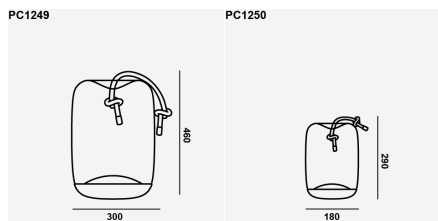

DOWNLOAD
SHARE

PC	PC1249	PC1250
NAME	CILINDRO TABLE BATTERY	SMALL CILINDRO TABLE BATTERY
PRICE A	2 285	1 963
PRICE B	-	-
PRICE C	-	-

IMPORTANT:

KNOT BATTERY IS FITTED WITH A USB CHARGING CABLE.
THE LAMP IS EQUIPPED WITH A TOUCH DIMMER.

TECHNICAL DETAILS:**GLASS COLOUR**

transparent glass (CGC23)
smoke grey - transparent glass (CGC516)
smoke brown - transparent glass (CGC538)
opaline - transparent glass (CGC38)

GLASS SURFACE

glossy surface (CGSU66)
matte inner glass finish (CGSU880)

BODY FINISH

copper (CCS584)
brass (CCS69)
brushed stainless steel (CCS68)
metal - black matte powder coating with structure (CCS2673)

CABLE COLOUR

black charging cable USB 2/Mag, 5V (CECL2838)

ROPE

rope - natural (CRP970)

LED SOURCE

244mA, LED, 2.7W, 2700K, 580lm, RA80+, DIM (LEDS2864)

VOLTAGE/FREQUENCY

USB 5V,1,4A, IP44; 4W LED (PC1249)
USB 5V,1,4A, IP44; 2,7W LED (PC1250)

[BACK TO INDEX](#)

Download:

[WWW](#)[MORE INFO.](#)[PHOTOS](#)[INSTALLATION MANUAL](#)[DATASHEETS](#)[3DS](#)[DWG](#)[SKETCH UP](#)[LDT](#)

FAQ



DOWNLOAD
SHARE

PC	PC1155	PC1122	PC1123	PC1124
NAME	SOLO VERTICAL 400	SOLO VERTICAL 600	SOLO VERTICAL 800	SOLO VERTICAL 1000
PRICE A	1 408	1 636	1 771	1 975
PRICE B	1 478	1 699	1 841	2 054
PRICE C	-	-	-	-
SURCHARGES (NET)				
EXTRA CABLE UP TO 5M	+ 36	+ 36	+ 36	+ 36
TRIMLESS	+ 120	+ 120	+ 120	+ 120
DIM	+ 54	+ 54	+ 54	+ 54

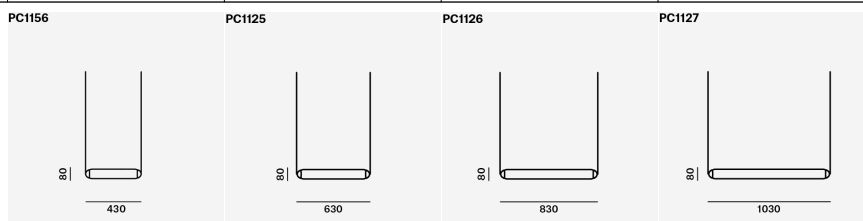

PC	PC1156	PC1125	PC1126	PC1127
NAME	SOLO HORIZONTAL 400	SOLO HORIZONTAL 600	SOLO HORIZONTAL 800	SOLO HORIZONTAL 1000
PRICE A	1 534	1 787	1 904	1 991
PRICE B	1 609	1 859	1 981	2 070
PRICE C	-	-	-	-
SURCHARGES (NET)				
EXTRA CABLE UP TO 5M	+ 72	+ 72	+ 72	+ 72
TRIMLESS	+ 120	+ 120	+ 120	+ 120
DIM	+ 54	+ 54	+ 54	+ 54

IMPORTANT:

THE PRICE OF THE LIGHT APPLIES TO THE NON-DIMMABLE VERSION. FOR THE DIMMABLE VERSIONS DIM OR DIM (TW) TUNABLE WHITE, A SURCHARGE WILL APPLY. TUNABLE WHITE IS AVAILABLE IN SELECTED COLLECTIONS ONLY. PRICE CATEGORY IS DETERMINED BY THE COLOUR OF THE GLASS.
PURO TUBE WITHOUT A SPOTLIGHT (BOTTOM PART GLASS). IT IS NOT POSSIBLE TO CONNECT PURO TUBE/SPOTLIGHT TO ANOTHER PURO SOLO.

TECHNICAL DETAILS:**GLASS COLOUR**

- A triplex opal (CGC39)
- B dark grey - opaline (CGC1507)

GLASS SURFACE

acid-etched both side surface (CGSU881)

BODY FINISH

- metal - black matte powder coating (CCS846)
- metal - white matte powder coating (CCS845)

CANOPY

- glass - black (CCSC2404)
- glass - white (CCSC2403)

- Trimless - cable version - white structure (CCSC2903)
- Trimless - cable version - black structure (CCSC2904)

CONNECTION METHOD

BROKIS connector 24V (CCM1019)

CABLE COLOUR

- textile cable - black (CECL519)
- textile cable - white (CECL521)

LED SOURCE

- 600mm 24V, LED, 13W, 2700K, 1105lm, RA90+, DIM (LEDS1926)
- 600mm 24V, LED, 13W, 4000K, 1220lm, RA90+, DIM (LEDS1927)
- 600mm 24V, LED, 13W, 5000K, 1300lm, RA90+, DIM (LEDS1928)
- 800mm 24V, LED, 18W, 2700K, 1530lm, RA90+, DIM (LEDS1929)
- 800mm 24V, LED, 18W, 4000K, 1695lm, RA90+, DIM (LEDS1930)
- 800mm 24V, LED, 18W, 5000K, 1810lm, RA90+, DIM (LEDS1931)
- 1000mm 24V, LED, 25W, 2700K, 1910lm, RA90+, DIM (LEDS1932)
- 1000mm 24V, LED, 25W, 4000K, 2115lm, RA90+, DIM (LEDS1933)
- 1000mm 24V, LED, 25W, 5000K, 2260lm, RA90+, DIM

(LEDS1934)

- 400mm 24V, LED, 11W, 2700K, 595lm, RA90+, DIM (LEDS2744)
- 400mm 24V, LED, 11W, 4000K, 659lm, RA90+, DIM (LEDS2745)
- 400mm 24V, LED, 11W, 5000K, 705lm, RA90+, DIM (LEDS2746)

DIMMABLE VERSION

- non-dimmable version (CEDV1457)
- DIM RF system - remote control version (CEDV1461)
- DIM PWM signal (CEDV1459)
- DIM 1-10V (CEDV1460)
- DIM DALI version (CEDV1458)
- DIM AC phase-cut (CEDV1730)
- DIM CASAMBI CBU-PWM4 (CEDV2854)

VOLTAGE/FREQUENCY

- 100-240VAC, 50/60Hz, 25W LED (PC1124, PC1127)
- 100-240VAC, 50/60Hz, 18W LED (PC1123, PC1126)
- 100-240VAC, 50/60Hz, 13W LED (PC1122, PC1125)
- 100-240VAC, 50/60Hz, 11W LED (PC1155, PC1156)

[BACK TO INDEX](#)

Download:

[WWW](#)[MORE INFO.](#)[PHOTOS](#)[INSTALLATION MANUAL](#)[DATASHEETS](#)[3DS](#)[DWG](#)[SKETCH UP](#)[LDT](#)



DOWNLOAD
SHARE

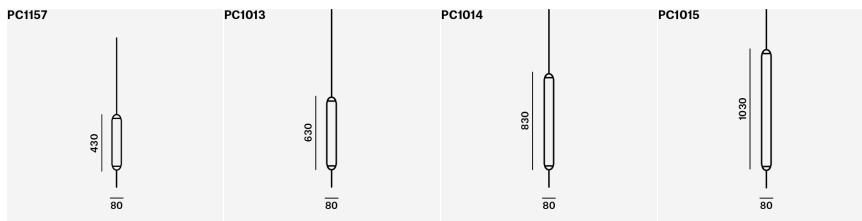

PC	PC1157	PC1013	PC1014	PC1015
NAME	SINGLE VERTICAL 400	SINGLE VERTICAL 600	SINGLE VERTICAL 800	SINGLE VERTICAL 1000
PRICE A	1 481	1 692	1 829	2 033
PRICE B	1 525	1 757	1 898	2 112
SURCHARGES (NET)				
EXTRA CABLE UP TO 5M	+ 36	+ 36	+ 36	+ 36
TRIMLESS	+ 120	+ 120	+ 120	+ 120
DIM	+ 54	+ 54	+ 54	+ 54

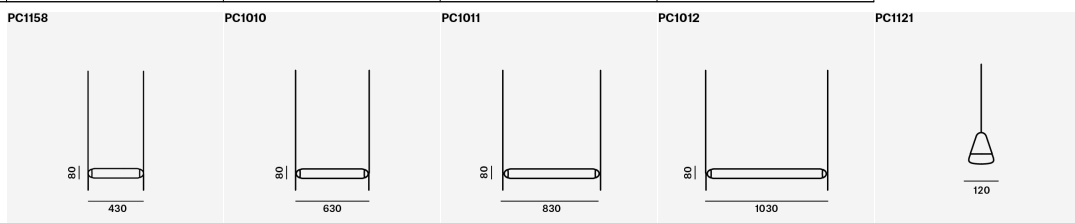

PC	PC1158	PC1010	PC1011	PC1012	PC1121
NAME	SINGLE HORIZONTAL 400	SINGLE HORIZONTAL 600	SINGLE HORIZONTAL 800	SINGLE HORIZONTAL 1000	SPOTLIGHT
PRICE A	1 673	1 843	1 961	2 047	388
PRICE B	1 740	1 915	2 038	2 126	-
SURCHARGES (NET)					
EXTRA CABLE UP TO 5M	+ 72	+ 72	+ 72	+ 72	+ 36
TRIMLESS	+ 120	+ 120	+ 120	+ 120	+ 120
DIM	+ 54	+ 54	+ 54	+ 54	-

IMPORTANT:

THE PRICE OF THE LIGHT APPLIES TO THE NON-DIMMABLE VERSION. FOR THE DIMMABLE VERSIONS DIM OR DIM (TW) TUNABLE WHITE, A SURCHARGE WILL APPLY. TUNABLE WHITE IS AVAILABLE IN SELECTED COLLECTIONS ONLY. PRICE CATEGORY IS DETERMINED BY THE COLOUR OF THE GLASS.
PURO TUBE WITH AN OPTION TO CONNECT TO IT ANOTHER PURO TUBE OR A SPOTLIGHT (PC1121).

TECHNICAL DETAILS:

GLASS COLOUR

- A triplex opal (CGC39)
- B dark grey - opaline (CGC1507)

GLASS SURFACE

acid-etched both side surface (CGSU881)

BOTTOM GLASS COLOUR

- transparent glass (CGGB812)
- smoke grey - transparent glass (CGGB977)
- triplex opal (CGGB979)

BOTTOM GLASS FINISH

- glossy surface (CGSUB890)
- acid-etched both side surface (CGSUB891)

BODY FINISH

- metal - black matte powder coating (CCS846)
- metal - white matte powder coating (CCS845)

CANOPY

- glass - black (CCSC2404)
- glass - white (CCSC2403)
- metal - black matte powder coating (CCSC619)
- metal - white matte powder coating (CCSC618)

- Trimless - cable version - white structure (CCSC2903)
- Trimless - cable version - black structure (CCSC2904)

CONNECTION METHOD

BROKIS connector 24V (CCM1019)

CABLE COLOUR

- textile cable - black (CECL519)
- textile cable - white (CECL521)

LED SOURCE

- 600mm 24V, LED, 13W, 2700K, 1105lm, RA90+, DIM (LEDS1926)
- 600mm 24V, LED, 13W, 4000K, 1220lm, RA90+, DIM (LEDS1927)
- 600mm 24V, LED, 13W, 5000K, 1300lm, RA90+, DIM (LEDS1928)
- 800mm 24V, LED, 18W, 2700K, 1530lm, RA90+, DIM (LEDS1929)
- 800mm 24V, LED, 18W, 4000K, 1695lm, RA90+, DIM (LEDS1930)
- 800mm 24V, LED, 18W, 5000K, 1810lm, RA90+, DIM (LEDS1931)
- 1000mm 24V, LED, 25W, 2700K, 1910lm, RA90+, DIM (LEDS1932)
- 1000mm 24V, LED, 25W, 4000K, 2115lm, RA90+, DIM (LEDS1933)
- 1000mm 24V, LED, 25W, 5000K, 2260lm, RA90+, DIM (LEDS1934)
- 400mm 24V, LED, 11W, 2700K, 595lm, RA90+, DIM (LEDS2744)

- 400mm 24V, LED, 11W, 4000K, 659lm, RA90+, DIM (LEDS2745)
- 400mm 24V, LED, 11W, 5000K, 705lm, RA90+, DIM (LEDS2746)

LED SOURCE OF THE BOTTOM PART

- 24V, LED, 5W, 2700K, 425lm, RA90, DIM (CEBBP1031)
- 24V, LED, 5W, 4000K, 470lm, RA90+, DIM (CEBBP2755)
- 24V, LED, 5W, 5000K, 503lm, RA90+, DIM (CEBBP2756)

DIMMABLE VERSION

- non-dimmable version (CEDV1457)
- DIM RF system - remote control version (CEDV1461)
- DIM PWM signal (CEDV1459)
- DIM 1-10V (CEDV1460)
- DIM DALI version (CEDV1458)
- DIM AC phase-cut (CEDV1730)
- DIM CASAMBI CBU-PWM4 (CEDV2854)

VOLTAGE/FREQUENCY

- 24VDC, 5W LED (PC1121)
- 100-240VAC, 50/60Hz, 25W LED (PC1012, PC1015)
- 100-240VAC, 50/60Hz, 18W LED (PC1011, PC1014)
- 100-240VAC, 50/60Hz, 13W LED (PC1010, PC1013)
- 100-240VAC, 50/60Hz, 11W LED (PC1157, PC1158)

[BACK TO INDEX](#)

Download:

- WWW
- MORE INFO.
- PHOTOS
- INSTALLATION MANUAL
- DATASHEETS
- 3DS
- DWG
- SKETCH UP
- LDT

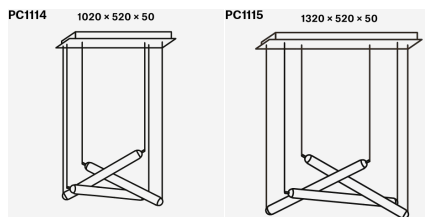

DOWNLOAD
SHARE

PC	PC1114	PC1115
NAME	ECLECTIC RECTANGULAR SET 800	ECLECTIC RECTANGULAR SET 1000
PRICE A	4 740	5 098
PRICE B	4 883	5 251
PRICE C	-	-
SURCHARGES (NET)		
EXTRA CABLE UP TO 5M	+ 130	+ 130
DIM	+ 54	+ 54

IMPORTANT:

THE PRICE OF THE LIGHT APPLIES TO THE NON-DIMMABLE VERSION. FOR THE DIMMABLE VERSIONS DIM OR DIM (TW) TUNABLE WHITE, A SURCHARGE WILL APPLY. TUNABLE WHITE IS AVAILABLE IN SELECTED COLLECTIONS ONLY.
PRICE CATEGORY IS DETERMINED BY THE COLOUR OF THE GLASS.

TECHNICAL DETAILS:**GLASS COLOUR**

- A triplex opal (CGC39)
- B dark grey - opaline (CGC1507)

GLASS SURFACE

acid-etched both side surface (CGSU881)

BODY FINISH

- metal - black matte powder coating (CCS846)
- metal - white matte powder coating (CCS845)

CANOPY

- metal - black matte powder coating (CCSC619)
- metal - white matte powder coating (CCSC618)

CONNECTION METHOD

BROKIS connector 24V (CCM1019)

CABLE COLOUR

- textile cable - black (CECL519)
- textile cable - white (CECL521)

LED SOURCE

- 800mm 24V, LED, 18W, 2700K, 1530lm, RA90+, DIM (LEDS1929)
- 800mm 24V, LED, 18W, 4000K, 1695lm, RA90+, DIM (LEDS1930)
- 800mm 24V, LED, 18W, 5000K, 1810lm, RA90+, DIM (LEDS1931)
- 1000mm 24V, LED, 25W, 2700K, 1910lm, RA90+, DIM (LEDS1932)
- 1000mm 24V, LED, 25W, 4000K, 2115lm, RA90+, DIM (LEDS1933)

(LEDS1933)

1000mm 24V, LED, 25W, 5000K, 2260lm, RA90+, DIM (LEDS1934)

DIMMABLE VERSION

- non-dimmable version (CEDV1457)
- DIM RF system - remote control version (CEDV1461)
- DIM PWM signal (CEDV1459)
- DIM 1-10V (CEDV1460)
- DIM DALI version (CEDV1458)
- DIM AC phase-cut (CEDV1730)
- DIM CASAMBI CBU-PWM4 (CEDV2854)

VOLTAGE/FREQUENCY

- 100-240VAC, 50/60Hz, 75W LED (PC1115)
- 100-240VAC, 50/60Hz, 54W LED (PC1114)

[BACK TO INDEX](#)

Download:

[WWW](#) | [MORE INFO.](#) | [PHOTOS](#) | [INSTALLATION MANUAL](#) | [DATASHEETS](#) | [3DS](#) | [DWG](#) | [SKETCH UP](#) | [LDT](#)

FAQ





DOWNLOAD
SHARE

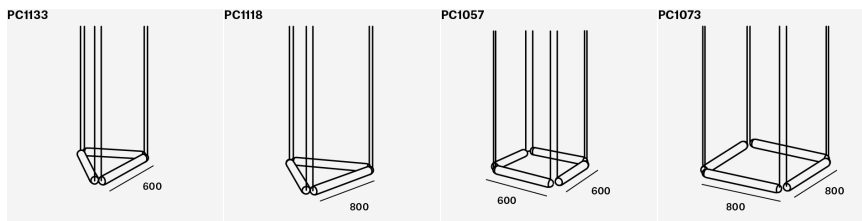

PC	PC1133	PC1118	PC1057	PC1073
NAME	CONTOUR TRIANGLE 600	CONTOUR TRIANGLE 800	CONTOUR SQUARE 600	CONTOUR SQUARE 800
PRICE A	5 012	5 344	6 684	7 124
PRICE B	5 212	5 560	6 950	7 411
PRICE C	-	-	-	-
SURCHARGES (NET)				
EXTRA CABLE UP TO 5M	+ 130	+ 130	+ 173	+ 173
DIM	+ 54	+ 54	+ 54	+ 54

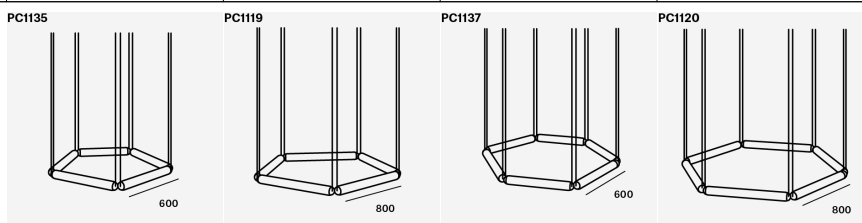

PC	PC1135	PC1119	PC1137	PC1120
NAME	CONTOUR PENTAGON 600	CONTOUR PENTAGON 800	CONTOUR HEXAGON 600	CONTOUR HEXAGON 800
PRICE A	8 354	8 906	10 025	10 687
PRICE B	8 687	9 265	10 424	11 118
PRICE C	-	-	-	-
SURCHARGES (NET)				
EXTRA CABLE UP TO 5M	+ 216	+ 216	+ 259	+ 259
DIM	+ 54	+ 54	+ 54	+ 54

IMPORTANT:

THE PRICE OF THE LIGHT APPLIES TO THE NON-DIMMABLE VERSION. FOR THE DIMMABLE VERSIONS DIM OR DIM (TW) TUNABLE WHITE, A SURCHARGE WILL APPLY. TUNABLE WHITE IS AVAILABLE IN SELECTED COLLECTIONS ONLY.
PRICE CATEGORY IS DETERMINED BY THE COLOUR OF THE GLASS.

TECHNICAL DETAILS:

GLASS COLOUR

- A triplex opal (CGC39)
- B dark grey - opaline (CGC1507)

GLASS SURFACE

acid-etched both side surface (CGSU881)

BODY FINISH

- metal - black matte powder coating (CCS846)
- metal - white matte powder coating (CCS845)

CANOPY

- metal - black matte powder coating (CCSC619)
- metal - white matte powder coating (CCSC618)

CONNECTION METHOD

BROKIS connector 24V (CCM1019)

CABLE COLOUR

- textile cable - black (CECL519)
- textile cable - white (CECL521)

LED SOURCE

- 600mm 24V, LED, 13W, 2700K, 1105lm, RA90+, DIM (LEDS1926)
- 600mm 24V, LED, 13W, 4000K, 1220lm, RA90+, DIM (LEDS1927)
- 600mm 24V, LED, 13W, 5000K, 1300lm, RA90+, DIM (LEDS1928)
- 800mm 24V, LED, 18W, 2700K, 1530lm, RA90+, DIM (LEDS1929)
- 800mm 24V, LED, 18W, 4000K, 1695lm, RA90+, DIM (LEDS1930)
- 800mm 24V, LED, 18W, 5000K, 1810lm, RA90+, DIM (LEDS1931)

DIMMABLE VERSION

- non-dimmable version (CEDV1457)
- DIM RF system - remote control version (CEDV1461)
- DIM PWM signal (CEDV1459)
- DIM 1-10V (CEDV1460)
- DIM DALI version (CEDV1458)
- DIM AC phase-cut (CEDV1730)
- DIM CASAMBI CBU-PWM4 (CEDV2854)

VOLTAGE/FREQUENCY

- 100-240VAC, 50/60Hz, 90W LED (PC1119)
- 100-240VAC, 50/60Hz, 78W LED (PC1137)
- 100-240VAC, 50/60Hz, 72W LED (PC1073)
- 100-240VAC, 50/60Hz, 60W LED (PC1135)
- 100-240VAC, 50/60Hz, 54W LED (PC1118)
- 100-240VAC, 50/60Hz, 52W LED (PC1057)
- 100-240VAC, 50/60Hz, 39W LED (PC1133)
- 100-240VAC, 50/60Hz, 108W LED (PC1120)

[BACK TO INDEX](#)

Download:

- [WWW](#)
- [MORE INFO.](#)
- [PHOTOS](#)
- [INSTALLATION MANUAL](#)
- [DATASHEETS](#)
- [3DS](#)
- [DWG](#)
- [SKETCH UP](#)
- [LDT](#)

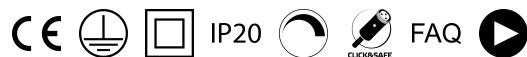

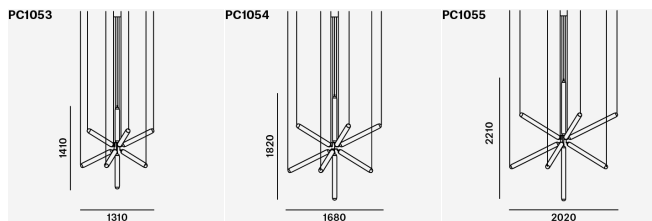
DOWNLOAD
SHARE

PC	PC1053	PC1054	PC1055
NAME	SPARKLE 600	SPARKLE 800	SPARKLE 1000
PRICE A	23 880	26 532	29 185
PRICE B	25 135	27 929	30 721
PRICE C	-	-	-
SURCHARGES (NET)			
EXTRA CABLE UP TO 5M	+ 360	+ 360	+ 360
DIM	+ 54	+ 54	+ 54

IMPORTANT:

THE PRICE OF THE LIGHT APPLIES TO THE NON-DIMMABLE VERSION. FOR THE DIMMABLE VERSIONS DIM OR DIM (TW) TUNABLE WHITE, A SURCHARGE WILL APPLY. TUNABLE WHITE IS AVAILABLE IN SELECTED COLLECTIONS ONLY.
PRICE CATEGORY IS DETERMINED BY THE COLOUR OF THE GLASS.

TECHNICAL DETAILS:**GLASS COLOUR**

- A** triplex opal (CGC39)
- B** dark grey - opaline (CGC1507)

GLASS SURFACE

acid-etched both side surface (CGSU881)

BODY FINISH

- metal - black matte powder coating (CCS846)
- metal - white matte powder coating (CCS845)

CANOPY

- metal - black matte powder coating (CCSC619)
- metal - white matte powder coating (CCSC618)

CONNECTION METHOD

BROKIS connector 24V (CCM1019)

CABLE COLOUR

- textile cable - black (CECL519)
- textile cable - white (CECL521)

LED SOURCE

- 600mm 24V, LED, 13W, 2700K, 1105lm, RA90+, DIM (LEDS1926)
- 600mm 24V, LED, 13W, 4000K, 1220lm, RA90+, DIM (LEDS1927)
- 600mm 24V, LED, 13W, 5000K, 1300lm, RA90+, DIM (LEDS1928)
- 800mm 24V, LED, 18W, 2700K, 1530lm, RA90+, DIM (LEDS1929)
- 800mm 24V, LED, 18W, 4000K, 1695lm, RA90+, DIM (LEDS1930)
- 800mm 24V, LED, 18W, 5000K, 1810lm, RA90+, DIM (LEDS1931)
- 1000mm 24V, LED, 25W, 2700K, 1910lm, RA90+, DIM (LEDS1932)

- 1000mm 24V, LED, 25W, 4000K, 2115lm, RA90+, DIM (LEDS1933)
- 1000mm 24V, LED, 25W, 5000K, 2260lm, RA90+, DIM (LEDS1934)

DIMMABLE VERSION

- non-dimmable version (CEDV1457)
- DIM RF system - remote control version (CEDV1461)
- DIM PWM signal (CEDV1459)
- DIM 1-10V (CEDV1460)
- DIM DALI version (CEDV1458)
- DIM AC phase-cut (CEDV1730)
- DIM CASAMBI CBU-PWM4 (CEDV2854)

VOLTAGE/FREQUENCY

- 100-240VAC, 50/60Hz, 300W LED (PC1055)
- 100-240VAC, 50/60Hz, 216W LED (PC1054)
- 100-240VAC, 50/60Hz, 156W LED (PC1053)

[BACK TO INDEX](#)

Download:

[WWW](#) | [MORE INFO.](#) | [PHOTOS](#) | [INSTALLATION MANUAL](#) | [DATASHEETS](#) | [3DS](#) | [DWG](#) | [SKETCH UP](#) | [LDT](#)

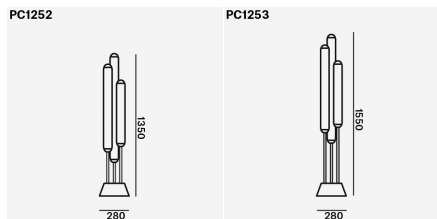
DOWNLOAD
SHARE

PC	PC1252	PC1253
NAME	FLOOR 3 TUBES 1350	FLOOR 3 TUBES 1550
PRICE A	6 410	6 410
PRICE B	-	-
PRICE C	-	-

IMPORTANT:

PURO FLOOR 3 TUBES 1350 AND PURO FLOOR 3 TUBES 1550 COMPRISE PURO TUBES IN THE FOLLOWING LENGTHS: 1x 1000MM, 1x 800MM AND 1x 600MM. IN THE PURO FLOOR COLLECTION, DIFFERENT COLOURS FOR THE GLASS AND METAL END CAPS CAN BE ORDERED ONLY FOR THE SMALLEST 600MM TUBE (THE METAL ROD OF THE SMALLEST TUBE MUST BE THE SAME COLOUR AS FOR THE OTHER TWO TUBES). FOR EXAMPLE, IF THE 800MM TUBE AND 1000MM TUBE (METAL AND GLASS PARTS) ARE IN WHITE, THEN THE SMALLEST 600MM TUBE WITH BLACK METAL END CAPS AND DARK GREY-OPALINE GLASS WILL BE ON A WHITE ROD.

TECHNICAL DETAILS:**GLASS COLOUR**

triplex opal (CGC39)
dark grey - opaline (CGC1507)

GLASS SURFACE

acid-etched both side surface (CGSU881)

BODY FINISH

metal - black matte powder coating with structure (CCS2673)

metal - white matte powder coating with structure (CCS2809)

CABLE COLOUR

textile cable - black (CECL519)
textile cable - white (CECL521)

LED SOURCE

24V, LED, 45W, 2700K, 2400lm, RA80+, DIM (LEDS2833)
24V, LED, 45W, 4000K, 2400lm, RA80+, DIM (LEDS2834)

24V, LED, 45W, 5000K, 2400lm, RA80+, DIM (LEDS2835)

DIMMABLE VERSION

DIM RF system - remote control version (CEDV1461)
DIM CASAMBI CBU-PWM4 (CEDV2854)

VOLTAGE/FREQUENCY

100-240VAC, 50/60Hz, 56W LED

[BACK TO INDEX](#)

Download:

[WWW](#)[MORE INFO.](#)[PHOTOS](#)[INSTALLATION MANUAL](#)[DATASHEETS](#)[3DS](#)[DWG](#)[SKETCH UP](#)[LDT](#)

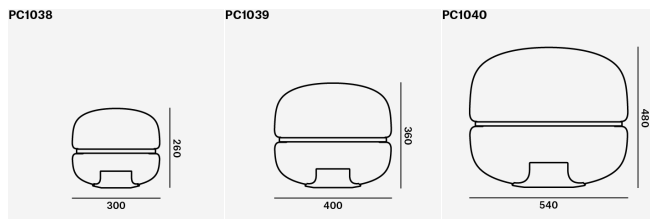
DOWNLOAD
SHARE

PC	PC1038	PC1039	PC1040
NAME	S	M	L
PRICE A	2 927	3 971	5 047
PRICE B	-	-	-
PRICE C	3 829	5 239	6 696

IMPORTANT:

PRICE CATEGORY IS DETERMINED BY THE VERSION OF THE BASE OR THE PLATE.
TABLE AND FLOOR LAMPS ARE EQUIPPED WITH A HAND DIMMER.

TECHNICAL DETAILS:**GLASS COLOUR**

transparent glass (CGC23)
smoke grey - transparent glass (CGC516)
amber - transparent glass (CGC515)
light pink - transparent glass (CGC46)
dark rosé - transparent glass (CGC1625)

GLASS SURFACE

glossy surface (CGSU66)

SURFACE FINISH OF THE BASE

A European oak - stained white (CSFB1575)

European oak - stained black (CSFB1574)

- C** onyx white (CSFB1535)
- onyx honey (CSFB1576)

SURFACE FINISH OF THE PLATE

- A** BROKISGLASS - smoke grey matte (CSOP1577)
- BROKISGLASS - triplex opal matte (CSOP1578)
- C** onyx white (CSOP1532)
- onyx honey (CSOP1533)

CABLE COLOUR

textile cable - black (CECL519)
textile cable - white (CECL521)
textile cable - dark grey (CECL520)
textile cable - light grey (CECL1918)

RECOMMENDED BULBS

230V, GX53, 10W, 2700K, 700lm, RA90, 100°, DIM (CEB717)

SOCKET

GX53

[BACK TO INDEX](#)

Download:

[WWW](#)[MORE INFO.](#)[PHOTOS](#)[INSTALLATION MANUAL](#)[DATASHEETS](#)[3DS](#)[DWG](#)[SKETCH UP](#)[LDT](#)

IP20



FAQ



DOWNLOAD
SHARE

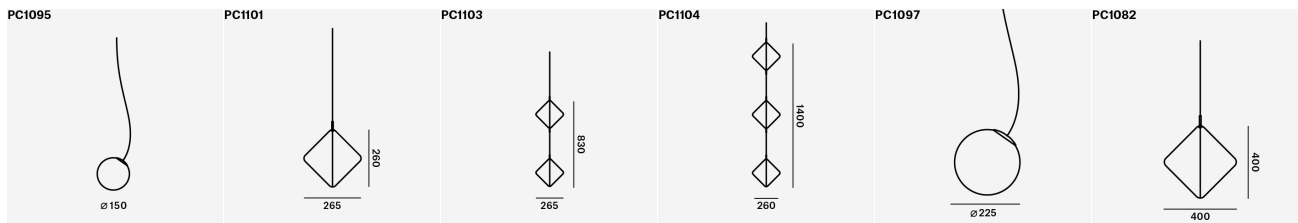

PC	PC1095	PC1101	PC1103	PC1104	PC1097	PC1082
NAME	SMALL PENDENT SPHERE	SMALL SINGLE PENDENT FRAME	SMALL DOUBLE PENDENT FRAME	SMALL TRIPLE PENDENT FRAME	LARGE PENDENT SPHERE	LARGE PENDENT SINGLE FRAME
PRICE A	440	237	474	711	735	410
PRICE B	-	-	-	-	-	-
PRICE C	-	-	-	-	-	-
SURCHARGES (NET)						
EXTRA CABLE UP TO 5M	-	+ 43	+ 43	+ 43	-	+ 43
CASAMBI	+ 78	-	-	-	+ 78	-

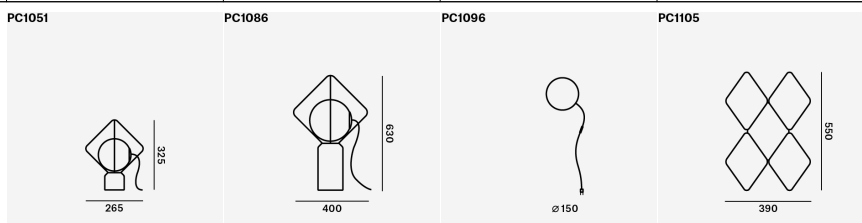

PC	PC1051	PC1086	PC1096	PC1105
NAME	SMALL TABLE	LARGE TABLE	SMALL SINGLE WALL SPHERE	SMALL WALL FRAME SET OF 5
PRICE A	1 114	1 984	482	1 755
PRICE B	-	-	-	-
PRICE C	-	-	-	-

IMPORTANT:

THE PENDENT AND WALL SPHERES MUST BE ORDERED IN COMBINATION WITH METAL FRAMES, I.E. NEITHER THE SPHERES NOR THE METAL FRAMES MAY BE PURCHASED SEPARATELY. TABLE AND WALL LAMPS ARE EQUIPPED WITH A HAND DIMMER.

TECHNICAL DETAILS:

GLASS COLOUR

smoke grey - transparent glass (CGC516)
triplex opal (CGC39)
light pink - transparent glass (CGC46)
without glass (CGC2820)

GLASS SURFACE

acid-etched both side surface (CGSU881)

BASE FINISH

satinated Carrara marble (CSFB2361) (PC1051, PC1086)
satinated Nero Marquina marble (CSFB2360) (PC1051, PC1086)
satinated Rosso Francia marble (CSFB2682) (PC1051, PC1086)
satinated Grigio Talami marble (CSFB2681) (PC1051, PC1086)

BODY FINISH

metal - black matte powder coating with structure (CCSC2673)

CANOPY

metal - black matte powder coating with structure (CCSC2674)

CABLE COLOUR

textile cable - black (CECL519) (PC1051, PC1095, PC1096, PC1086, PC1097)
textile cable - white (CECL521) (PC1051, PC1095, PC1096, PC1086, PC1097)
textile cable - light grey (CECL1918) (PC1051, PC1095, PC1096, PC1086, PC1097)

RECOMMENDED BULBS

230V, G9, 4.5W, 2700K, DIM (CEB2773)
230V, G9, 4.5W, 4000K, DIM (CEB2774)
230V, G9, 4.5W, 2700K, DIM (CEB1828)
230V, G9, 4.5W, 4000K, DIM (CEB2359)

DIMMABLE VERSION

TRIAC - STANDARD OPTION (CEDV2865) (PC1095, PC1097)
CASAMBI CBU-TED (CEDV2855) (PC1095, PC1097)

SOCKET

G9

[BACK TO INDEX](#)

Download:

- [WWW](#)
- [MORE INFO.](#)
- [PHOTOS](#)
- [INSTALLATION MANUAL](#)
- [DATASHEETS](#)
- [3DS](#)
- [DWG](#)
- [SKETCH UP](#)
- [LDT](#)

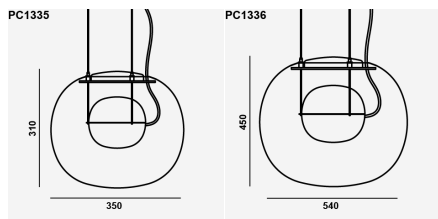

DOWNLOAD
SHARE

PC	PC1335	PC1336
NAME	SMALL	LARGE
PRICE A	1 908	2 580
PRICE B	-	-
PRICE C	-	-
SURCHARGES (NET)		
EXTRA CABLE UP TO 5M	+ 58	+ 58
DIM	+ 54	+ 54
DIM (TW)	+ 78	+ 78

IMPORTANT:

IN 2023, THE BIG ONE COLLECTION WILL UNDERGO SIGNIFICANT TECHNOLOGICAL INNOVATION THAT WILL SUBSTANTIALLY INCREASE THE OUTPUT OF THE LIGHT AND FACILITATE HANDLING. DUE TO THESE EXTENSIVE MODIFICATIONS, BIG ONE LIGHTS ARE AVAILABLE UNDER THE NEW CODES PC1335 AND PC1336. THE PRICE OF THE LIGHT APPLIES TO THE NON-DIMMABLE VERSION. FOR THE DIMMABLE VERSIONS DIM OR DIM (TW) TUNABLE WHITE, A SURCHARGE WILL APPLY. TUNABLE WHITE IS AVAILABLE IN SELECTED COLLECTIONS ONLY. THE COLLECTION IS AVAILABLE WITH TUNABLE WHITE, WHICH ALLOWS THE USER TO ADJUST THE COLOUR TEMPERATURE OF THE LIGHT SOURCE. THIS SOLUTION BEARS THE DESIGNATION DIM (TW).

TECHNICAL DETAILS:**GLASS COLOUR**

transparent glass (CGC23)
smoke grey - transparent glass (CGC516)
light smoke brown - transparent glass (CGC2889)

GLASS SURFACE

glossy surface (CGSU66)

COLOUR OF THE INNER GLASS

smoke grey - transparent glass (CGCI685)
red - transparent glass (CGCI913)
light pink - transparent glass (CGCI2356)
triplex opal (CGCI907)
smoke brown - transparent glass (CGCI2931)

GLASS SURFACE OF THE INNER GLASS

acid-etched both side surface (CGSUI905)

BODY FINISH

silver anodized (CCS775)

CANOPY

brushed stainless steel (CCSC974)

CABLE COLOUR

textile cable - black (CECL519)
textile cable - white (CECL521)
textile cable - light grey (CECL1918)

LED SOURCE

DIM, 24V, LED, 15W, 2700K, 1894lm, RA90+ (LEDS2949) (PC1335)
DIM (TW), 24V, LED, 15W, 2700K-6500K, 947lm-1017lm, RA90+ (LEDS2950) (PC1335)
DIM, 24V, LED, 18W, 2700K, 2592lm, RA90+ (LEDS2951) (PC1336)

DIM (TW), 24V, LED, 18W, 2700K-6500K, 1296lm-1391lm, RA90+ (LEDS2952) (PC1336)

DIMMABLE VERSION

non-dimmable version (CEDV1457)
DIM RF system - remote control version (CEDV1461)
DIM PWM signal (CEDV1459)
DIM 1-10V (CEDV1460)
DIM DALI version (CEDV1458)
DIM AC phase-cut (CEDV1730)
DIM CASAMBI CBU-PWM4 (CEDV2854)
DIM (TW) CASAMBI CBU-PWM4 (CEDV2942)
DIM (TW) DALI version (CEDV2944)

VOLTAGE/FREQUENCY

100-240VAC, 50/60Hz, 18W LED (PC1336)
100-240VAC, 50/60Hz, 15W LED (PC1335)

[BACK TO INDEX](#)

Download:

[WWW](#)[MORE INFO.](#)[PHOTOS](#)[INSTALLATION MANUAL](#)[DATASHEETS](#)[3DS](#)[DWG](#)[SKETCH UP](#)[LDT](#)



DOWNLOAD
SHARE

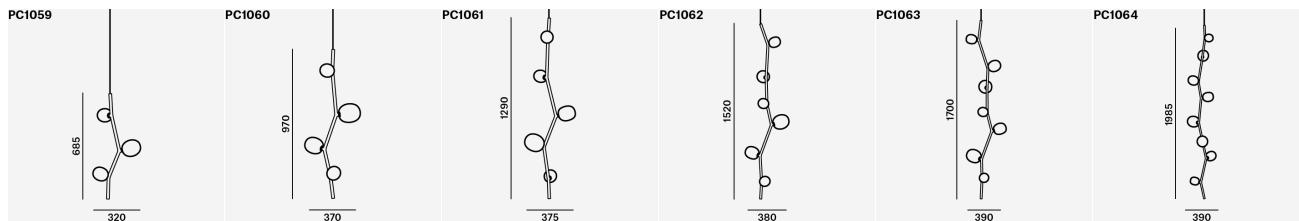

PC	PC1059	PC1060	PC1061	PC1062	PC1063	PC1064
NAME	VERTICAL 3	VERTICAL 4	VERTICAL 5	VERTICAL 6	VERTICAL 7	VERTICAL 8
PRICE A	2 705	3 380	4 130	4 834	5 622	6 514
PRICE B	-	-	-	-	-	-
PRICE C	-	-	-	-	-	-
SURCHARGES (NET)						
EXTRA CABLE UP TO 5M	+ 58	+ 58	+ 58	+ 58	+ 58	+ 58
TRIMLESS	+ 120	+ 120	+ 120	+ 120	+ 120	+ 120
DIM	+ 54	+ 54	+ 54	+ 54	+ 54	+ 54

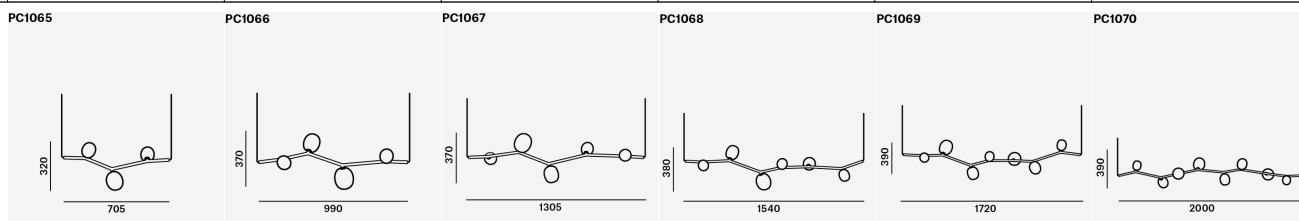

PC	PC1065	PC1066	PC1067	PC1068	PC1069	PC1070
NAME	HORIZONTAL 3	HORIZONTAL 4	HORIZONTAL 5	HORIZONTAL 6	HORIZONTAL 7	HORIZONTAL 8
PRICE A	2 705	3 380	4 130	4 834	5 622	6 514
PRICE B	-	-	-	-	-	-
PRICE C	-	-	-	-	-	-
SURCHARGES (NET)						
EXTRA CABLE UP TO 5M	+ 58	+ 58	+ 58	+ 58	+ 58	+ 58
TRIMLESS	+ 120	+ 120	+ 120	+ 120	+ 120	+ 120
DIM	+ 54	+ 54	+ 54	+ 54	+ 54	+ 54

IMPORTANT:

THE PRICE OF THE LIGHT APPLIES TO THE NON-DIMMABLE VERSION. FOR THE DIMMABLE VERSIONS DIM OR DIM (TW) TUNABLE WHITE, A SURCHARGE WILL APPLY. TUNABLE WHITE IS AVAILABLE IN SELECTED COLLECTIONS ONLY.
IVY IS A MODULAR SYSTEM FEATURING GLASS COMPONENTS OF THREE SIZES AND THREE COLOURS POSITIONED ON BRANCHES IN SEQUENCE ACCORDING TO THE DESIGN OF THE LIGHT. THE THREE GLASS COLOURS CAN BE COMBINED WITHIN THE LIGHT.

TECHNICAL DETAILS:

GLASS COLOUR

smoke grey - transparent glass (CGC516)
triplex opal (CGC39)
light pink - transparent glass (CGC46)

GLASS SURFACE

acid-etched both side surface (CGSU881)

BODY FINISH

metal - white matte powder coating with structure (CCS2809)
metal - anthracite grey matte powder coating with structure (CCS2811)

CANOPY

metal - white matte powder coating with structure (CCSC2810)
metal - anthracite grey matte powder coating with structure (CCSC2812)

Trimless - cable version - white structure (CCSC2903)
Trimless - cable version - black structure (CCSC2904)

CABLE COLOUR

textile cable - black (CECL519)
textile cable - white (CECL521)

CONNECTION METHOD

BROKIS connector 24V (CCM1019)

RECOMMENDED BULBS

12V, G4, 1.2W, 2700K, 91lm, DIM (CEB1818)

DIMMABLE VERSION

non-dimmable version (CEDV1457)
DIM RF system - remote control version (CEDV1461)
DIM PWM signal (CEDV1459)
DIM 1-10V (CEDV1460)

DIM DALI version (CEDV1458)
DIM AC phase-cut (CEDV1730)
DIM CASAMBI CBU-PWM4 (CEDV2854)

VOLTAGE/FREQUENCY

100-240VAC, 50/60Hz, max.8x2W LED - G4/12V (PC1064, PC1070)
100-240VAC, 50/60Hz, max.7x2W LED - G4/12V (PC1063, PC1069)
100-240VAC, 50/60Hz, max.6x2W LED - G4/12V (PC1062, PC1068)
100-240VAC, 50/60Hz, max.5x2W LED - G4/12V (PC1061, PC1067)
100-240VAC, 50/60Hz, max.4x2W LED - G4/12V (PC1060, PC1066)
100-240VAC, 50/60Hz, max.3x2W LED - G4/12V (PC1059, PC1065)

[BACK TO INDEX](#)

Download:

- WWW
- MORE INFO.
- PHOTOS
- INSTALLATION MANUAL
- DATASHEETS
- 3DS
- DWG
- SKETCH UP
- LDT





DOWNLOAD
SHARE

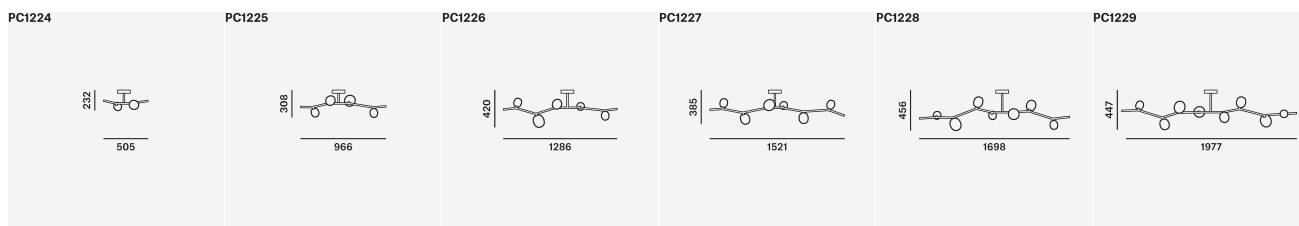

PC	PC1224	PC1225	PC1226	PC1227	PC1228	PC1229
NAME	CEILING 2	CEILING 4	CEILING 5	CEILING 6	CEILING 7	CEILING 8
PRICE A	2 039	3 121	3 948	4 573	5 269	6 092
PRICE B	-	-	-	-	-	-
PRICE C	-	-	-	-	-	-
SURCHARGES (NET)						
DIM	+ 54	+ 54	+ 54	+ 54	+ 54	+ 54

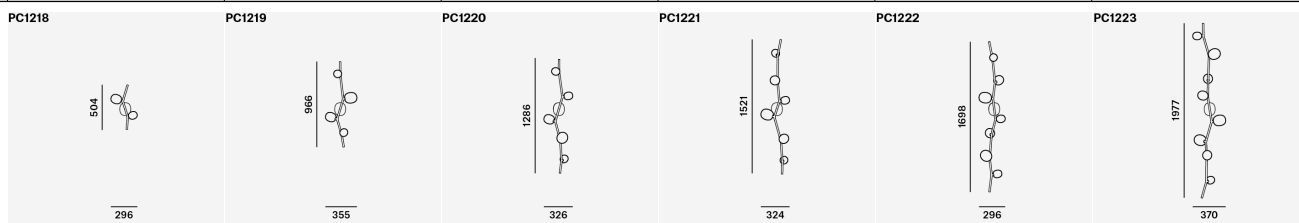

PC	PC1218	PC1219	PC1220	PC1221	PC1222	PC1223
NAME	WALL 2	WALL 4	WALL 5	WALL 6	WALL 7	WALL 8
PRICE A	2 039	3 121	3 948	4 573	5 269	6 092
PRICE B	-	-	-	-	-	-
PRICE C	-	-	-	-	-	-
SURCHARGES (NET)						
DIM	+ 54	+ 54	+ 54	+ 54	+ 54	+ 54

IMPORTANT:

THE PRICE OF THE LIGHT APPLIES TO THE NON-DIMMABLE VERSION. FOR THE DIMMABLE VERSIONS DIM OR DIM (TW) TUNABLE WHITE, A SURCHARGE WILL APPLY. TUNABLE WHITE IS AVAILABLE IN SELECTED COLLECTIONS ONLY.
 IVY IS A MODULAR SYSTEM FEATURING GLASS COMPONENTS OF THREE SIZES AND THREE COLOURS POSITIONED ON BRANCHES IN SEQUENCE ACCORDING TO THE DESIGN OF THE LIGHT.
 THE THREE GLASS COLOURS CAN BE COMBINED WITHIN THE LIGHT.
 THE IVY WALL VARIANT HAS A TOUCH DIMMER INTEGRATED INTO THE SIDE OF THE METAL BRANCH.

TECHNICAL DETAILS:

GLASS COLOUR
 smoke grey - transparent glass (CGC516)
 triplex opal (CGC39)
 light pink - transparent glass (CGC46)

GLASS SURFACE
 acid-etched both side surface (CGSU881)

BODY FINISH
 metal - white matte powder coating with structure

(CCS2809)
 metal - anthracite grey matte powder coating with structure (CCS2811)

RECOMMENDED BULBS
 12V, G4, 1.2W, 2700K, 91lm, DIM (CEB1818)

DIMMABLE VERSION
 non-dimmable version (CEDV1457)
 DIM CASAMBI CBU-PWM4 (CEDV2854)

touch dimming (CEDV2871)

VOLTAGE/FREQUENCY
 100-240V, 50-60 Hz, Max. 8x2W/12V - G4 (PC1229, PC1223)
 100-240V, 50-60 Hz, Max. 7x2W/12V - G4 (PC1228, PC1222)
 100-240V, 50-60 Hz, Max. 6x2W/12V - G4 (PC1227, PC1221)
 100-240V, 50-60 Hz, Max. 5x2W/12V - G4 (PC1226, PC1220)
 100-240V, 50-60 Hz, Max. 4x2W/12V - G4 (PC1225, PC1219)
 100-240V, 50-60 Hz, Max. 2x2W/12V - G4 (PC1224, PC1218)

[BACK TO INDEX](#)

Download:

- WWW
- MORE INFO.
- PHOTOS
- INSTALLATION MANUAL
- DATASHEETS
- 3DS
- DWG
- SKETCH UP
- LDT

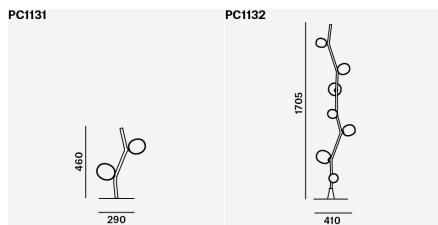

DOWNLOAD
SHARE

PC	PC1131	PC1132
NAME	TABLE	FLOOR
PRICE A	2 173	4 974
PRICE B	-	-
PRICE C	-	-

IMPORTANT:

IVY IS A MODULAR SYSTEM FEATURING GLASS COMPONENTS OF THREE SIZES AND THREE COLOURS POSITIONED ON BRANCHES IN SEQUENCE ACCORDING TO THE DESIGN OF THE LIGHT. THE THREE GLASS COLOURS CAN BE COMBINED WITHIN THE LIGHT. THE IVY TABLE AND IVY FLOOR VARIANTS HAVE A TOUCH DIMMER INTEGRATED INTO THE TOP PART OF THE METAL BRANCH. FOR TRANSPORTATION PURPOSES, IVY FLOOR IS SHIPPED AS TWO SEPARATE PIECES – THE BASE AND THE BRANCH – WHICH ARE THEN JOINED WITH A CONNECTOR.

TECHNICAL DETAILS:**GLASS COLOUR**

smoke grey - transparent glass (CGC516)
triplex opal (CGC39)
light pink - transparent glass (CGC46)

GLASS SURFACE

acid-etched both side surface (CGSU881)

CONNECTION METHOD

BROKIS connector 24V (CCM1019)

BODY FINISH

metal - white matte powder coating with structure (CCS2809)
metal - anthracite grey matte powder coating with structure (CCS2811)

CABLE COLOUR

cable without textile - black (CECL2719)

RECOMMENDED BULBS

12V, G4, 1.2W, 2700K, 91lm, DIM (CEB1818)

DIMMABLE VERSION

touch dimming (CEDV2871)

VOLTAGE/FREQUENCY

100-240VAC,50-60Hz,max.7x1,5W LED G4/12V (PC1132)
100-240VAC,50-60Hz,max.2x2W LED G4/12V (PC1131)

[BACK TO INDEX](#)

Download:

[WWW](#)[MORE INFO.](#)[PHOTOS](#)[INSTALLATION MANUAL](#)[DATASHEETS](#)[3DS](#)[DWG](#)[SKETCH UP](#)[LDT](#)

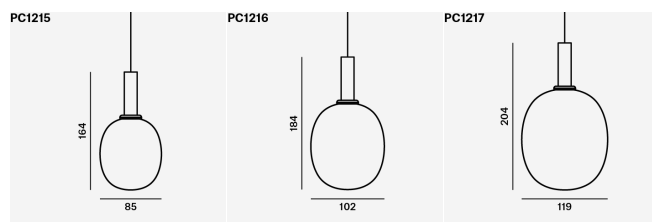
DOWNLOAD
SHARE

PC	PC1215	PC1216	PC1217
NAME	SINGLE S	SINGLE M	SINGLE L
PRICE A	370	379	390
PRICE B	-	-	-
PRICE C	-	-	-
SURCHARGES (NET)			
EXTRA CABLE UP TO 5M	+ 36	+ 36	+ 36

IMPORTANT:

DIMMING IS CONFIGURED ACCORDING TO THE LIGHTING COMPOSITION AND PROJECT SPECIFICATIONS.

TECHNICAL DETAILS:**GLASS COLOUR**smoke grey - transparent glass (CGC516)
triplex opal (CGC39)
light pink - transparent glass (CGC46)**GLASS SURFACE**

acid-etched both side surface (CGSU881)

BODY FINISH

metal - white matte powder coating with structure

(CCS2809)metal - anthracite grey matte powder coating with structure
(CCS2811)**CANOPY FINISH**metal - white matte powder coating with structure
(CCSC2810)metal - anthracite grey matte powder coating with structure
(CCSC2812)**CABLE COLOUR**

coaxial cable - silver (CECL2772)

RECOMMENDED BULBS

12V, G4, 1.2W, 2700K, 91lm, DIM (CEB1818)

VOLTAGE/FREQUENCY

100-240V, 50-60 Hz, Max. 2W/12V - G4

[BACK TO INDEX](#)

Download:

[WWW](#)[MORE INFO.](#)[PHOTOS](#)[INSTALLATION MANUAL](#)[DATASHEETS](#)[3DS](#)[DWG](#)[SKETCH UP](#)[LDT](#)

IP20



FAQ



DOWNLOAD
SHARE

PC1233

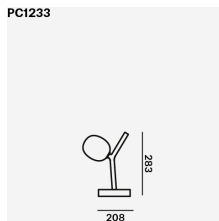

PC	PC1233
NAME	TABLE BATTERY
PRICE A	551
PRICE B	-
PRICE C	-

IMPORTANT:

IVY BATTERY IS FITTED WITH GLASS SIZE M AND A USB CHARGING CABLE.
THE LIGHT CAN ALSO BE CHARGED WIRELESSLY VIA AN INDUCTION SYSTEM, WHICH IS SOLD SEPARATELY.
IVY BATTERY CAN BE DIMMED TO 3 INTENSITY LEVELS BY TOUCHING ANY PART OF THE METAL BODY.

TECHNICAL DETAILS:**GLASS COLOUR**

smoke grey - transparent glass (CGC516)
triplex opal (CGC39)
light pink - transparent glass (CGC46)

GLASS SURFACE

acid-etched both side surface (CGSU881)

BODY FINISH

metal - white matte powder coating with structure (CCS2809)
metal - anthracite grey matte powder coating with structure (CCS2811)

CABLE COLOUR

silver charging cable USB 2/USB-C, 5V (CECL2839)
black charging cable USB 2/USB-C, 5V (CECL2837)

RECOMMENDED BULBS

12V, G4, 1.2W, 2700K, 91lm, DIM (CEB1818)

DIMMABLE VERSION

touch dimming (CEDV2871)

VOLTAGE/FREQUENCY

USB, 5V, 1,5A

[BACK TO INDEX](#)**Download:**[WWW](#)[MORE INFO.](#)[PHOTOS](#)[INSTALLATION MANUAL](#)[DATASHEETS](#)[3DS](#)[DWG](#)[SKETCH UP](#)[LDT](#)

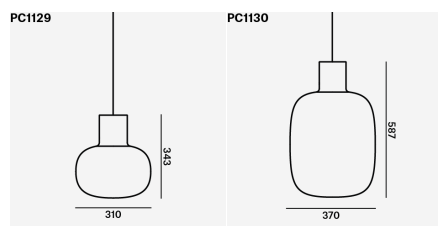
DOWNLOAD
SHARE

PC	PC1129	PC1130
NAME	MEDIUM	LARGE
PRICE A	1 339	1 715
PRICE B	1 416	1 799
PRICE C	-	-
SURCHARGES (NET)		
EXTRA CABLE UP TO 5M	+ 36	+ 36
TRIMLESS	+ 120	+ 120
CASAMBI	+ 78	+ 78

IMPORTANT:

AWA CAN BE ORDERED WITH ONE OF THE TWO BULBS LISTED BELOW. MORE INFORMATION ON THE BULBS CAN BE FOUND IN THE DATASHEETS.
AWA IS AVAILABLE WITH A NEW FINISH ON THE UPPER PART OF THE GLASS – GLOSS SANDBLASTED.

TECHNICAL DETAILS:**GLASS COLOUR**

transparent glass (CGC23)
smoke grey - transparent glass (CGC516)
smoke brown - transparent glass (CGC538)

GLASS SURFACE

A glossy surface (CGSU66)
B glossy - sandblasted (top part) (CGSU806)

BODY FINISH

copper (CCS584)
silver anodized (CCS775)
European oak - natural lacquer (wax) (CCS518)
American walnut - natural waxed (CCS757)

CANOPY

copper (CCSC896)
silver anodized (CCSC843)
European oak - natural lacquer (wax) (CCSC841)
American walnut - natural waxed (CCSC842)

Trimless – cable version – white structure (CCSC2903)
Trimless – cable version – black structure (CCSC2904)

CABLE COLOUR

textile cable - black (CECL519)
textile cable - light grey (CECL1918)

RECOMMENDED BULBS

230V, LED, E27, 12W, 2600K, 600lm, RA90, DIM - ART (CEB2832)
230V, LED, E27, 6W, 2000K, 200-250lm, RA90, DIM - FILAMENT LED (CEB2671)

DIMMABLE VERSION

TRIAC - STANDARD OPTION (CEDV2865)
CASAMBI CBU-TED (CEDV2855)

SOCKET

E27

[BACK TO INDEX](#)

Download:

[WWW](#)[MORE INFO.](#)[PHOTOS](#)[INSTALLATION MANUAL](#)[DATASHEETS](#)[3DS](#)[DWG](#)[SKETCH UP](#)[LDT](#)

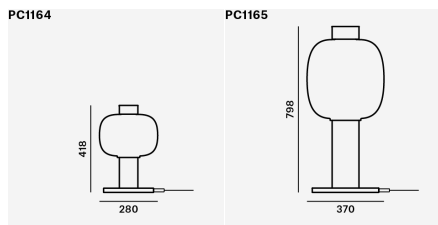
DOWNLOAD
SHARE

PC	PC1164	PC1165
NAME	SMALL	LARGE
PRICE A	1 783	2 311
PRICE B	-	-
PRICE C	-	-
CASAMBI	+ 78	+ 78

IMPORTANT:

TABLE AND FLOOR LAMPS ARE EQUIPPED WITH A HAND DIMMER.
IT IS POSSIBLE TO USE BONBORI INDOOR VERSION TEMPORARILY OUTSIDE. TO DO SO, YOU CAN USE A SPECIAL RUBBER BLACK CABLE WITH A CONNECTOR AND A LAMP SWITCH WITH IP44 PROTECTION.
THIS CABLE CAN BE ORDERED FROM BROKIS UNDER CODE CP11499.

TECHNICAL DETAILS:**GLASS COLOUR**

smoke grey - transparent glass (CGC516)
smoke brown - transparent glass (CGC538)
opaline - transparent glass (CGC38)
triplex opal (CGC39)

GLASS SURFACE

glossy surface (CGSU66)

BODY FINISH

metal - black matte powder coating (CCS846)

copper metallic (CCS2748)
grey metallic (CCS2749)

CONNECTION METHOD

BROKIS connector 230V (CCM2876)

CABLE COLOUR

textile cable - black (CECL519)
textile cable - light grey (CECL1918)

RECOMMENDED BULBS

230V, E27, 11W, 2700K, 1250lm, RA90, 360°, DIM
(CEBEU2750)

DIMMABLE VERSION

TRIAC - STANDARD OPTION (CEDV2865)
CASAMBI CBU-TED (CEDV2855)

SOCKET

E27

[BACK TO INDEX](#)

Download:

[WWW](#)[MORE INFO.](#)[PHOTOS](#)[INSTALLATION MANUAL](#)[DATASHEETS](#)[3DS](#)[DWG](#)[SKETCH UP](#)[LDT](#)[FAQ](#)

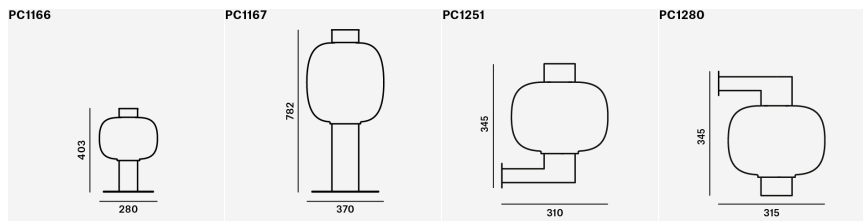
DOWNLOAD
SHARE

PC	PC1166	PC1167	PC1251	PC1280
NAME	OUTDOOR SMALL	OUTDOOR LARGE	WALL UP	WALL DOWN
PRICE A	1 703	2 311	2 012	2 012
PRICE B	-	-	-	-
PRICE C	-	-	-	-
CASAMBI	+ 78	+ 78	+ 78	+ 78

IMPORTANT:

IT IS RECOMMENDED FOR MAINTENANCE REASONS TO USE FOR BONBORI OUTDOOR TRIPLEX OPAL OR OPALINE GLASS DUE TO OUTDOOR INFLUENCES. BONBORI OUTDOOR IS ENGINEERED AS A POST LIGHT INTENDED FOR DIRECT WIRING USING TERMINAL CONNECTORS. THE LIGHT IS NOT FITTED WITH A POWER CABLE WITH PLUG AND THEREFORE CANNOT BE PLUGGED INTO A POWER OUTLET. THUS BONBORI OUTDOOR CAN ONLY BE USED IN EXTERIOR SETTINGS AND NOT IN THE INTERIOR. FOR USE INDOORS, THERE IS THE STANDARD BONBORI LIGHT. BONBORI WALL UP AND BONBORI WALL DOWN ARE STRUCTURALLY DIFFERENT LIGHTS AND THUS CANNOT BE INSTALLED BOTH WAYS. FOR EXAMPLE, BONBORI WALL UP MUST BE INSTALLED WITH THE METAL FIXTURE FACING UPWARDS; IT IS THE ONLY WAY THIS LIGHT CAN BE INSTALLED.

TECHNICAL DETAILS:**GLASS COLOUR**

smoke grey - transparent glass (CGC516)
smoke brown - transparent glass (CGC538)
opaline - transparent glass (CGC38)
triplex opal (CGC39)

GLASS SURFACE

glossy surface (CGSU66)

BODY FINISH

metal - black matte powder coating (CCS846)
copper metallic (CCS2748)
grey metallic (CCS2749)

RECOMMENDED BULBS

230V, E27, 11W, 2700K, 1250lm, RA90, 360°, DIM
(CEBEU2750)

DIMMABLE VERSION

TRIAC - STANDARD OPTION (CEDV2865)
CASAMBI CBU-TED (CEDV2855)

SOCKET

E27

[BACK TO INDEX](#)

Download:

[WWW](#)[MORE INFO.](#)[PHOTOS](#)[INSTALLATION MANUAL](#)[DATASHEETS](#)[3DS](#)[DWG](#)[SKETCH UP](#)[LDT](#)



DOWNLOAD
SHARE

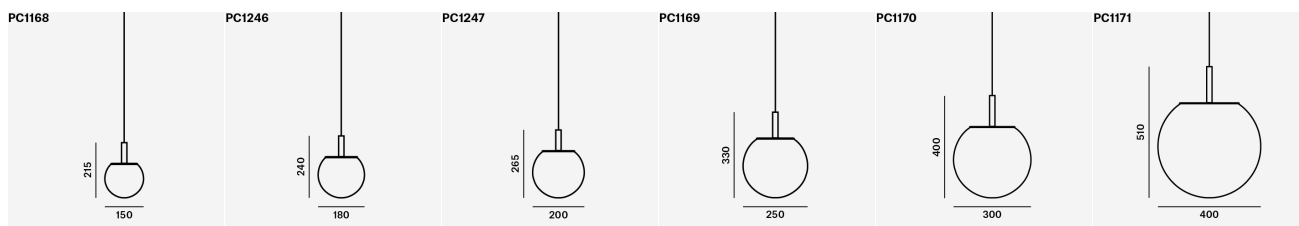

PC	PC1168	PC1246	PC1247	PC1169	PC1170	PC1171
NAME	150	180	200	250	300	400
PRICE A	388	403	437	504	566	685
PRICE B	-	-	-	-	-	-
PRICE C	-	-	-	-	-	-
SURCHARGES (NET)						
EXTRA CABLE UP TO 5M	+ 36	+ 36	+ 36	+ 36	+ 36	+ 36
TRIMLESS	+ 120	+ 120	+ 120	+ 120	+ 120	+ 120

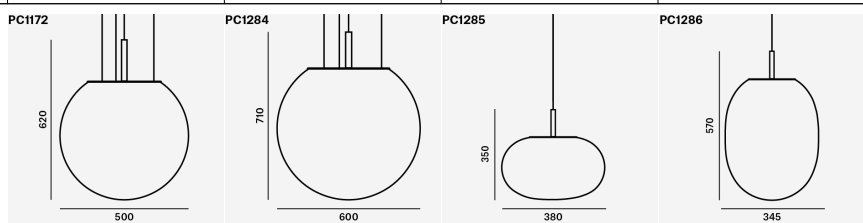

PC	PC1172	PC1284	PC1285	PC1286
NAME	500	600	OVAL 380	OVAL 345
PRICE A	1 195	2 372	744	744
PRICE B	-	-	-	-
PRICE C	-	-	-	-
SURCHARGES (NET)				
EXTRA CABLE UP TO 5M	+ 36	+ 36	+ 36	+ 36
TRIMLESS	-	-	+ 120	+ 120

IMPORTANT:

BULB IS NOT INCLUDED.
FOR PROPER BALANCING, SFERA 500 AND SFERA 600 ARE SUPPORTED WITH THREE WIRE ROPES ANCHORED IN THE CEILING CANOPY. THESE THREE WIRE ROPES FUNCTIONALLY SUBSTITUTE TRIMLESS SOLUTION AND THEREFORE THERE IS NO NEED TO PURCHASE TRIMLESS FOR SFERA 500 AND 600.

TECHNICAL DETAILS:

GLASS COLOUR
triplex opal (CGC39)

GLASS SURFACE
acid-etched both side surface (CGSU881) (PC1168, PC1169, PC1170, PC1171, PC1246, PC1247)
acid-etched outside surface (CGSU67) (PC1172, PC1284, PC1285, PC1286)

BODY FINISH
metal - black matte powder coating (CCS846)
metal - white matte powder coating (CCS845)

brushed aluminium transparent powder coating (CCS2841)

CANOPY
metal - black matte powder coating (CCSC619)
metal - white matte powder coating (CCSC618)
brushed aluminium transparent powder coating (CCSC2843)

Trimless – cable version – white structure (CCSC2903)
Trimless – cable version – black structure (CCSC2904)

CONNECTION METHOD
BROKIS connector 230V (CCM2876)

CABLE COLOUR
textile cable - black (CECL519)
textile cable - white (CECL521)
textile cable - light grey (CECL1918)

SOCKET
G9 (PC1168, PC1246, PC1247)
E27 (PC1169, PC1170, PC1171, PC1172, PC1284, PC1285, PC1286)

[BACK TO INDEX](#)

Download:

- [WWW](#)
- [MORE INFO.](#)
- [PHOTOS](#)
- [INSTALLATION MANUAL](#)
- [DATASHEETS](#)
- [3DS](#)
- [DWG](#)
- [SKETCH UP](#)
- [LDT](#)

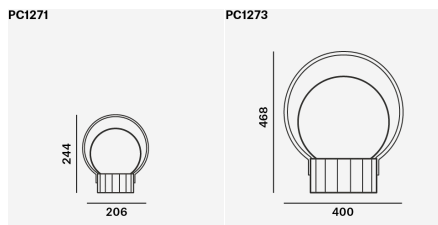

DOWNLOAD
SHARE

PC	PC1271	PC1273
NAME	PORTABLE SMALL	PORTABLE LARGE
PRICE A	1 157	1 823
PRICE B	-	-
PRICE C	-	-

IMPORTANT:

WITH REGARD FOR THE DESIGN OF THE LIGHT, THE COMBINATION OF GLASS AND GLASS FINISH IS PRECISELY SPECIFIED. THE TRIPLEX OPAL GLASS (WHITE) ALWAYS HAS A MATTE FINISH, WHILE THE SMOKE GREY GLASS AND SMOKE BROWN GLASS ALWAYS HAVE A GLOSS FINISH.
SFERA PORTABLE IS FITTED WITH A USB CHARGING CABLE.
THE LIGHT CAN ALSO BE CHARGED WIRELESSLY VIA AN INDUCTION SYSTEM, WHICH IS SOLD SEPARATELY.
THE LIGHT CAN BE TOUCH DIMMED TO 3 INTENSITY LEVELS.

TECHNICAL DETAILS:**GLASS COLOUR**

smoke grey - transparent glass (CGC516)
smoke brown - transparent glass (CGC538)
triplex opal (CGC39)

GLASS SURFACE

glossy surface (CGSU66)
acid-etched both side surface (CGSU881)

BODY FINISH

brushed stainless steel (CCS68)
metal - black matte powder coating (CCS846)

BASE FINISH

high performance concrete - natural (CSFB2840)
high performance concrete - terracotta (CSFB2842)

CABLE COLOUR

black charging cable USB 2/USB-C, 5V (CECL2837)

LED SOURCE

12V, LED, 2.8W, 2700K, 310lm, RA80+, DIM (LEDS2870)
12V, LED, 4W, 2700K, 696lm, RA80+, DIM (LEDS2845)

VOLTAGE/FREQUENCY

5V/max.2A USB-C, Max.5.9W-LED (PC1273)
5V/max.2A USB-C, Max.2.8W-LED (PC1271)

[BACK TO INDEX](#)

Download:

[WWW](#)[MORE INFO.](#)[PHOTOS](#)[INSTALLATION MANUAL](#)[DATASHEETS](#)[3DS](#)[DWG](#)[SKETCH UP](#)[LDT](#)

IP44 FAQ





DOWNLOAD
SHARE

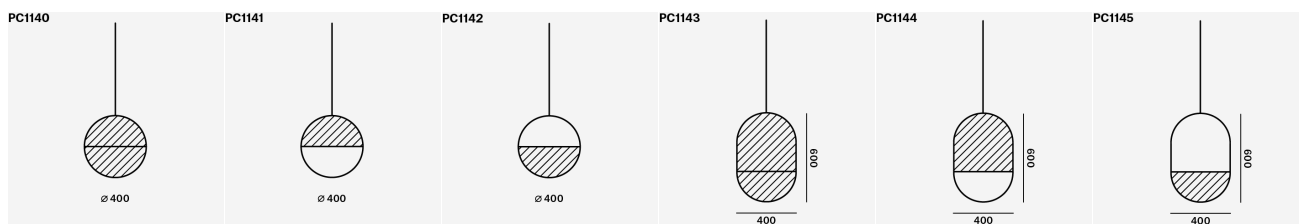

PC	PC1140	PC1141	PC1142	PC1143	PC1144	PC1145
NAME	CIRCLE FULL	CIRCLE 1/2 TOP	CIRCLE 1/2 BOTTOM	OVAL FULL BOTTOM	OVAL 2/3 TOP	OVAL 1/3 BOTTOM
PRICE A	4 919	3 745	3 745	5 602	4 890	4 114
SURCHARGES (NET)						
EXTRA CABLE UP TO 5M	+ 58	+ 58	+ 58	+ 58	+ 58	+ 58
DIM	+ 54	+ 54	+ 54	+ 54	+ 54	+ 54
DIM (TW)	+ 78	+ 78	+ 78	+ 78	+ 78	+ 78

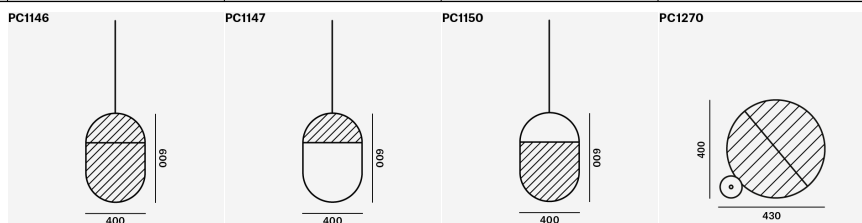

PC	PC1146	PC1147	PC1150	PC1270
NAME	OVAL FULL TOP	OVAL 1/3 TOP	OVAL 2/3 BOTTOM	TABLE
PRICE A	5 602	4 114	4 890	2 491
SURCHARGES (NET)				
EXTRA CABLE UP TO 5M	+ 58	+ 58	+ 58	-
DIM	+ 54	+ 54	+ 54	-
DIM (TW)	+ 78	+ 78	+ 78	+ 78

IMPORTANT:

THE PRICE OF THE LIGHT APPLIES TO THE NON-DIMMABLE VERSION. FOR THE DIMMABLE VERSIONS DIM OR DIM (TW) TUNABLE WHITE, A SURCHARGE WILL APPLY. TUNABLE WHITE IS AVAILABLE IN SELECTED COLLECTIONS ONLY.
THE COLLECTION IS AVAILABLE WITH TUNABLE WHITE, WHICH ALLOWS THE USER TO ADJUST THE COLOUR TEMPERATURE OF THE LIGHT SOURCE. THIS SOLUTION BEARS THE DESIGNATION DIM (TW). IT IS POSSIBLE TO COMBINE DIFFERENT COLOURS OF BROKISGLASS FOR INDIVIDUAL GLASS PARTS (TOP AND BOTTOM).

TECHNICAL DETAILS:

TOP BROKISGLASS COLOUR

- triple opal BROKISGLASS (CGCB2676)
- smoke grey BROKISGLASS (CGC2677)
- smoke brown BROKISGLASS (CGC2720)
- yellow - triple opal BROKISGLASS (CGC2722)
- light pink - triple opal BROKISGLASS (CGC2723)
- orange - triple opal BROKISGLASS (CGC2724)
- red - triple opal BROKISGLASS (CGC2725)
- light blue - triple opal BROKISGLASS (CGC2726)
- turquoise - triple opal BROKISGLASS (CGC2727)
- dark green - triple opal BROKISGLASS (CGC2804)
- green apple - triple opal BROKISGLASS (CGC2728)
- amber - triple opal BROKISGLASS (CGC2730)
- cognac - triple opal BROKISGLASS (CGC2731)
- grey - triple opal BROKISGLASS (CGC2747)

BOTTOM BROKISGLASS COLOUR

- triple opal BROKISGLASS (CGGB2768)
- smoke grey - BROKISGLASS (CGGB2799)
- smoke brown BROKISGLASS (CGGB2792)
- yellow - triple opal BROKISGLASS (CGGB2797)
- light pink - triple opal BROKISGLASS (CGGB2769)
- orange - triple opal BROKISGLASS (CGGB2798)
- red - triple opal BROKISGLASS (CGGB2793)
- light blue - triple opal BROKISGLASS (CGGB2795)
- turquoise - triple opal BROKISGLASS (CGGB2794)
- dark green - triple opal BROKISGLASS (CGGB2805)
- green apple - triple opal BROKISGLASS (CGGB2803)

- amber - triple opal BROKISGLASS (CGGB2800)
- cognac - triple opal BROKISGLASS (CGGB2802)
- grey - triple opal BROKISGLASS (CGGB2770)

GLASS SURFACE

- glossy finish (front face) (CGSU2736)
- acid-etched finish (front face) (CGSU2737)

BODY FINISH

- metal - black matte powder coating with structure (CCS2673)

CANOPY FINISH

- metal - black matte powder coating with structure (CCSC2674)

CABLE COLOUR

- textile cable - black (CECL519)

LED SOURCE

- 24V, LED, 40W, 2700K, 4600lm, RA90+, DIM (LEDS2778) (PC1140, PC1270)
- DIM (TW), 24V, LED, 40W, 2700K-6500K, RA90+ (LEDS2966) (PC1140, PC1270)
- 24V, LED, 20W, 2700K, 2300lm, RA90+, DIM (LEDS2781) (PC1141, PC1142, PC1145, PC1147)
- DIM (TW), 24V, LED, 20W, 2700K-6500K, RA90+ (LEDS2967)

- (PC1141, PC1142, PC1145, PC1147)
24V, LED, 50W, 2700K, 7900lm, RA90+, DIM (LEDS2787) (PC1143, PC1146)
- DIM (TW), 24V, LED, 50W, 2700K-6500K, RA90+ (LEDS2968) (PC1143, PC1146)
- 24V, LED, 30W, 2700K, 5600lm, RA90+, DIM (LEDS2784) (PC1144, PC1150)
- DIM (TW), 24V, LED, 30W, 2700K-6500K, RA90+ (LEDS2969) (PC1144, PC1150)

DIMMABLE VERSION

- DIM RF system - remote control version (CEDV1461)
- DIM PWM signal (CEDV1459)
- DIM 1.10V (CEDV1460)
- DIM DALI version (CEDV1458)
- DIM CASAMBI CBU-PWM4 (CEDV2854)
- DIM (TW) CASAMBI CBU-PWM4 (CEDV2942)
- DIM (TW) DALI version (CEDV2944)
- touch dimming (CEDV2871)

VOLTAGE/FREQUENCY

- 120-240VAC, 50/60Hz, 70W LED (PC1143, PC1146)
- 120-240VAC, 50/60Hz, 50W LED (PC1144, PC1150)
- 120-240VAC, 50/60Hz, 40W LED (PC1140, PC1270)
- 120-240VAC, 50/60Hz, 20W LED (PC1141, PC1142, PC1145, PC1147)

[BACK TO INDEX](#)

Download:

- [WWW](#)
- [MORE INFO.](#)
- [PHOTOS](#)
- [INSTALLATION MANUAL](#)
- [DATASHEETS](#)
- [3DS](#)
- [DWG](#)
- [SKETCH UP](#)
- [LDT](#)





DOWNLOAD
SHARE

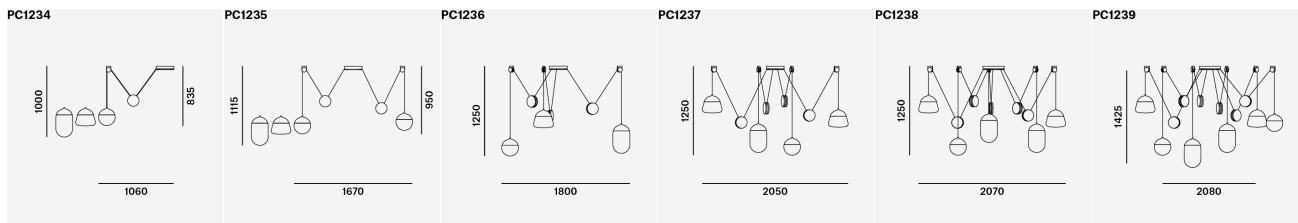

PC	PC1234	PC1235	PC1236	PC1237	PC1238	PC1239
NAME	1	2	3	4	5	6
PRICE A	1 736	2 717	3 643	4 639	6 234	7 511
PRICE B	-	-	-	-	-	-
PRICE C	-	-	-	-	-	-
SURCHARGES (NET)						
DIM	+ 54	+ 54	+ 54	+ 54	+ 54	+ 54
DIM (TW)	+ 78	+ 78	+ 78	+ 78	+ 78	+ 78

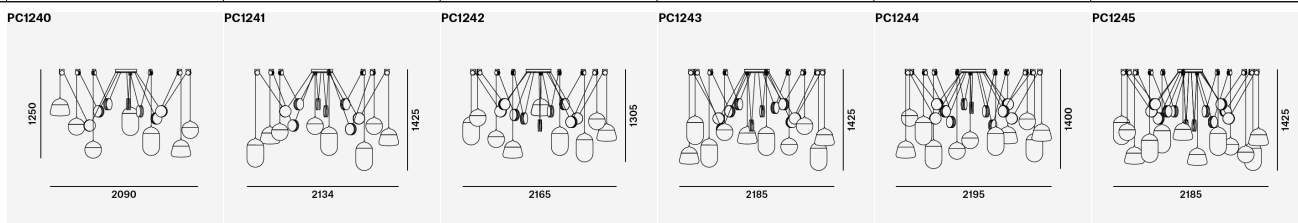

PC	PC1240	PC1241	PC1242	PC1243	PC1244	PC1245
NAME	7	8	9	10	11	12
PRICE A	8 880	10 346	12 464	14 143	15 918	17 789
PRICE B	-	-	-	-	-	-
PRICE C	-	-	-	-	-	-
SURCHARGES (NET)						
DIM	+ 54	+ 54	+ 54	+ 54	+ 54	+ 54
DIM (TW)	+ 78	+ 78	+ 78	+ 78	+ 78	+ 78

IMPORTANT:

THE PRICE OF THE LIGHT APPLIES TO THE NON-DIMMABLE VERSION. FOR THE DIMMABLE VERSIONS DIM OR DIM (TW) TUNABLE WHITE, A SURCHARGE WILL APPLY. TUNABLE WHITE IS AVAILABLE IN SELECTED COLLECTIONS ONLY.
THE COLLECTION IS AVAILABLE WITH TUNABLE WHITE, WHICH ALLOWS THE USER TO ADJUST THE COLOUR TEMPERATURE OF THE LIGHT SOURCE. THIS SOLUTION BEARS THE DESIGNATION DIM (TW).
IT IS POSSIBLE TO COMBINE DIFFERENT TYPES OF GLASS SHADES ACCORDING TO THE CLIENT'S REQUIREMENT. THE SHAPES OF THE SHADES AND THE LENGTHS IN THE PICTOGRAMS ARE ONLY ILLUSTRATIVE. PLEASE USE THE CONFIGURATOR.

TECHNICAL DETAILS:

GLASS COLOUR

smoke grey - transparent glass (CGC516)
triplex opal (CGC39)

GLASS SURFACE

acid-etched both side surface (CGSU881)

BODY FINISH

metal - black matte powder coating with structure (CCS2673)
metal - white matte powder coating with structure (CCS2809)

CANOPY FINISH

metal - black matte powder coating with structure (CCSC2674)
metal - white matte powder coating with structure

(CCSC2810)

CABLE COLOUR

textile cable - black (CECL519)
textile cable - white (CECL521)

LED SOURCE

DIM, 24V, LED, 19,7W, 2700K, 2147lm, RA90+ (LEDS2868)
DIM (TW), 24V, LED, 19,7W, 2700K-6500K, 2147lm-2304lm, RA90+ (LEDS2946)

DIMMABLE VERSION

non-dimmable version (CEDV1457)
DIM RF system - remote control version (CEDV1461)
DIM 1-10V (CEDV1460)
DIM DALI version (CEDV1458)
DIM AC phase-cut (CEDV1730)

DIM CASAMBI CBU-PWM4 (CEDV2854)

DIM (TW) CASAMBI CBU-PWM4 (CEDV2942)
DIM (TW) DALI version (CEDV2944)

VOLTAGE/FREQUENCY

100-260VAC, 50-60Hz, 87,5W LED (PC1240)
100-260VAC, 50-60Hz, 75W LED (PC1239)
100-260VAC, 50-60Hz, 62,5W LED (PC1238)
100-260VAC, 50-60Hz, 50W LED (PC1237)
100-260VAC, 50-60Hz, 37,5W LED (PC1236)
100-260VAC, 50-60Hz, 25W LED (PC1235)
100-260VAC, 50-60Hz, 150W LED (PC1245)
100-260VAC, 50-60Hz, 137,5W LED (PC1244)
100-260VAC, 50-60Hz, 125W LED (PC1243)
100-260VAC, 50-60Hz, 12,5W LED (PC1234)
100-260VAC, 50-60Hz, 112,5W LED (PC1242)
100-260VAC, 50-60Hz, 100W LED (PC1241)

[BACK TO INDEX](#)

Download:

- WWW
- MORE INFO.
- PHOTOS
- INSTALLATION MANUAL
- DATASHEETS
- 3DS
- DWG
- SKETCH UP
- LDT



Click this image to configure light.

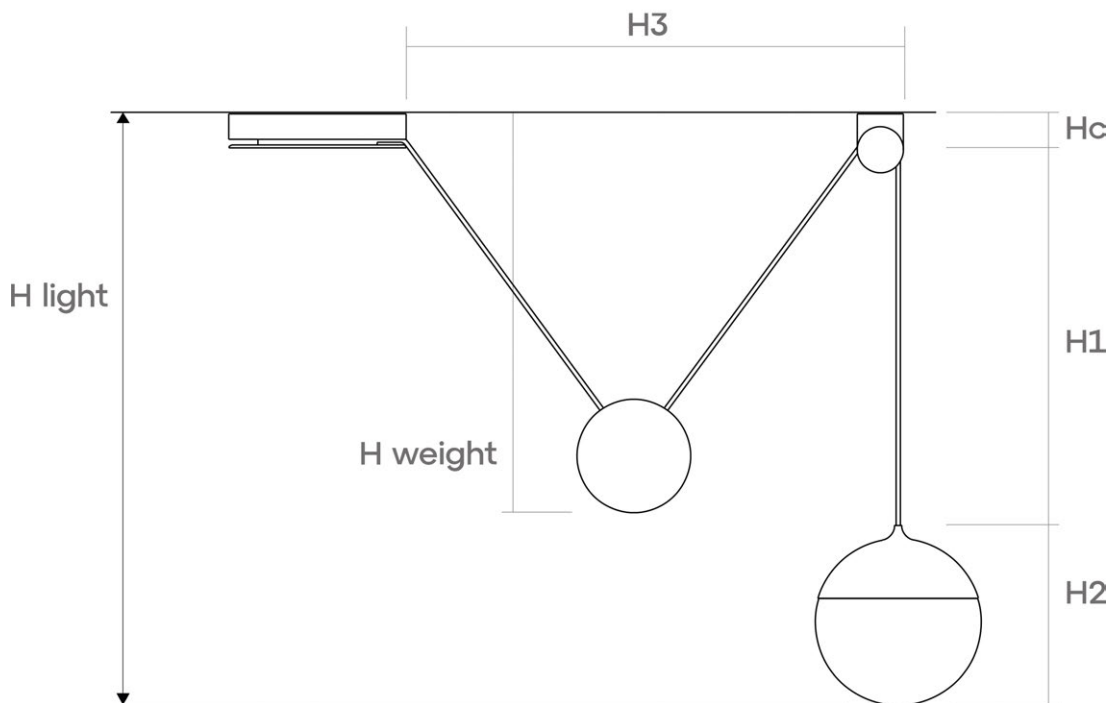
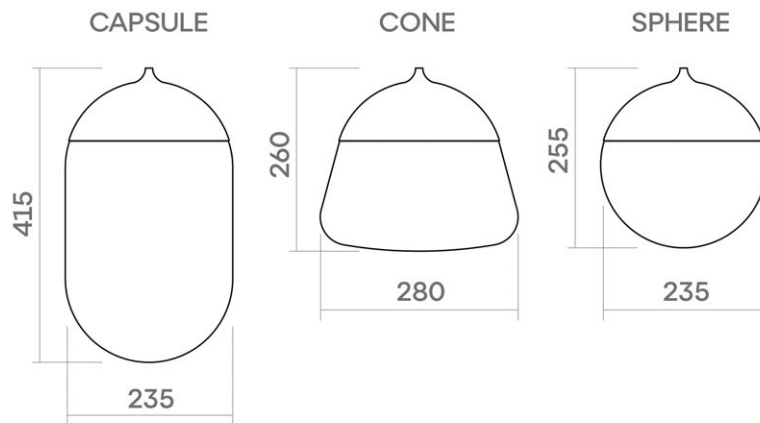

[BACK TO INDEX](#)

Download:

[WWW](#)

[MORE INFO.](#)

[PHOTOS](#)

[INSTALATION MANUAL](#)

[DATASHEETS](#)

[3DS](#)

[DWG](#)

[SKETCH UP](#)

[LDT](#)



IP20



[FAQ](#)





DOWNLOAD
SHARE

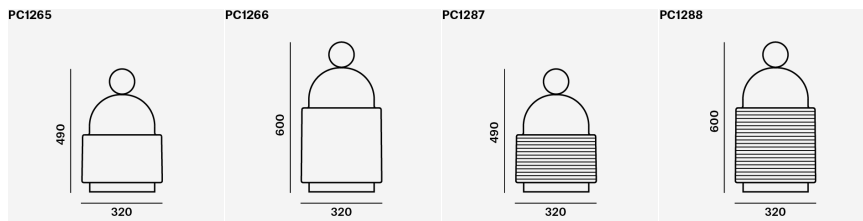

PC	PC1265	PC1266	PC1287	PC1288
NAME	SMALL	LARGE	LINES SMALL	LINES LARGE
PRICE A	2 273	2 417	2 357	2 542
PRICE B	-	-	-	-
PRICE C	-	-	-	-

IMPORTANT:

DOME NOMAD IS FITTED WITH A USB CHARGING CABLE.
THE LAMP IS EQUIPPED WITH A TOUCH DIMMER.

TECHNICAL DETAILS:

GLASS COLOUR

transparent glass (CGC23)
smoke grey - transparent glass (CGC516)
smoke brown - transparent glass (CGC538)
opaline - transparent glass (CGC38)
triplex opal (CGC39)

GLASS SURFACE

glossy surface (CGSU66)

BODY FINISH

copper (CCS584)
brass (CCS69)
metal - black matte powder coating with structure (CCS2673)
brushed stainless steel (CCS68)

CABLE COLOUR

black charging cable USB 2/Mag, 5V (CECL2838)

LED SOURCE

240mA, LED, 4W, 2700K, 950lm, RA80+, DIM (LEDS2836)

VOLTAGE/FREQUENCY

USB 5V,1,4A, IP44; 4W LED

[BACK TO INDEX](#)

Download:

[WWW](#)

[MORE INFO.](#)

[PHOTOS](#)

[INSTALLATION MANUAL](#)

[DATASHEETS](#)

[3DS](#)

[DWG](#)

[SKETCH UP](#)

[LDT](#)

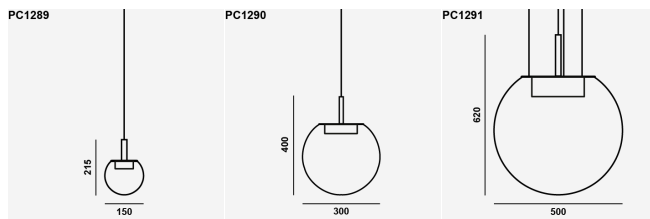

DOWNLOAD
SHARE

PC	PC1289	PC1290	PC1291
NAME	150	300	500
PRICE A	817	1 178	2 214
PRICE B	-	-	-
PRICE C	-	-	-
SURCHARGES (NET)			
EXTRA CABLE UP TO 5M	+ 36	+ 36	+ 36
TRIMLESS	+ 120	+ 120	-
DIM	+ 54	+ 54	+ 54
DIM (TW)	+ 78	+ 78	+ 78

IMPORTANT:

THE PRICE OF THE LIGHT APPLIES TO THE NON-DIMMABLE VERSION. FOR THE DIMMABLE VERSIONS DIM OR DIM (TW) TUNABLE WHITE, A SURCHARGE WILL APPLY. TUNABLE WHITE IS AVAILABLE IN SELECTED COLLECTIONS ONLY.

THE COLLECTION IS AVAILABLE WITH TUNABLE WHITE, WHICH ALLOWS THE USER TO ADJUST THE COLOUR TEMPERATURE OF THE LIGHT SOURCE. THIS SOLUTION BEARS THE DESIGNATION DIM (TW).

WITH REGARD TO THE DESIGN OF THE LIGHT, THE COMBINATIONS OF GLASS, METAL COMPONENTS, AND CABLE ARE STRICTLY PREDEFINED. FOR INSTANCE, LIGHT PINK-TRANSPARENT GLASS IS COMBINED WITH METAL COMPONENTS IN MATTE PINK POWDER COAT AND A LIGHT GREY CABLE. THESE DEFINED COMBINATIONS ARE LISTED UNDER THE ORBIS COLLECTION IN THE PRIVATE SECTION OF MY BROKIS.

FOR PROPER BALANCING, ORBIS 500 IS SUPPORTED WITH THREE WIRE ROPES ANCHORED IN THE CEILING CANOPY. THESE THREE WIRE ROPES FUNCTIONALLY SUBSTITUTE TRIMLESS SOLUTION AND THEREFORE THERE IS NO NEED TO PURCHASE TRIMLESS FOR ORBIS 500.

TECHNICAL DETAILS:**GLASS COLOUR**

smoke grey - transparent glass (CGC516)
transparent glass (CGC23)
light pink - transparent glass (CGC46)
amber - transparent glass (CGC515)
light smoke brown - transparent glass (CGC2889)

GLASS SURFACE

glossy surface (CGSU66)

BODY FINISH

metal - black matte powder coating (CCS846)
metal - grey-beige matte powder coat (CCS2910)
metal - pink matte powder coating (CCS2891)
metal - okra matte powder coating (CCS2893)
metal - khaki matte powder coating (CCS2895)

CANOPY

metal - black matte powder coating (CCSC619)
metal - grey-beige matte powder coat (CCSC2909)
metal - pink matte powder coating (CCSC2890)

metal - okra matte powder coating (CCSC2892)
metal - khaki matte powder coating (CCSC2894)

Trimless - cable version - white structure (CCSC2903)
Trimless - cable version - black structure (CCSC2904)

CONNECTION METHOD

BROKIS connector 24V (CCM1019)

CABLE COLOUR

textile cable - black (CECL519)
textile cable - light grey (CECL1918)

LED SOURCE

DIM, 24V, LED, 4.6W, 2700K, 538lm, RA90+ (LEDS2866) (PC1289)
DIM (TW), 24V, LED, 4.6W, 2700K-6500K, 538lm-577lm, RA90+ (LEDS2941) (PC1289)
DIM, 24V, LED, 8.2W, 2700K, 949lm, RA90+ (LEDS2867) (PC1290)
DIM (TW), 24V, LED, 8.2W, 2700K-6500K, 949lm-1019lm, RA90+ (LEDS2945) (PC1290)

DIM, 24V, LED, 19.7W, 2700K, 2147lm, RA90+ (LEDS2868) (PC1291)
DIM (TW), 24V, LED, 19.7W, 2700K-6500K, 2147lm-2304lm, RA90+ (LEDS2946) (PC1291)

DIMMABLE VERSION

non-dimmable version (CEDV1457)
DIM RF system - remote control version (CEDV1461)
DIM PWM signal (CEDV1459)
DIM 1-10V (CEDV1460)
DIM DALI version (CEDV1458)
DIM AC phase-cut (CEDV1730)
DIM CASAMBI CBU-PWM4 (CEDV2854)
DIM (TW) CASAMBI CBU-PWM4 (CEDV2942)
DIM (TW) DALI version (CEDV2944)

VOLTAGE/FREQUENCY

100-240 VAC, 50/60 Hz, 8.2W LED (PC1290)
100-240 VAC, 50/60 Hz, 4.6W LED (PC1289)
100-240 VAC, 50/60 Hz, 19.7W LED (PC1291)

[BACK TO INDEX](#)

Download:

[WWW](#)[MORE INFO.](#)[PHOTOS](#)[INSTALLATION MANUAL](#)[DATASHEETS](#)[3DS](#)[DWG](#)[SKETCH UP](#)[LDT](#)[FAQ](#)



DOWNLOAD
SHARE

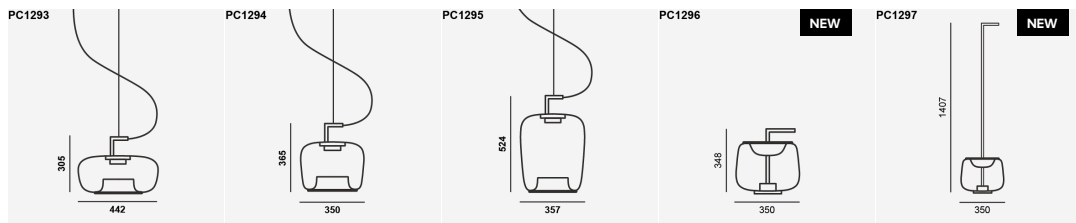

PC	PC1293	PC1294	PC1295	PC1296	PC1297
NAME	SHORT PENDENT	MEDIUM PENDENT	LONG PENDENT	TABLE	FLOOR
PRICE A	2 149	2 086	2 226	1 980	3 234
PRICE B	-	-	-	-	-
PRICE C	-	-	-	-	-
SURCHARGES (NET)					
EXTRA CABLE UP TO 5M	+ 43	+ 43	+ 43	-	-
DIM	+ 54	+ 54	+ 54	-	-
DIM (TW)	+ 78	+ 78	+ 78	-	-

IMPORTANT:

THE PRICE OF THE LIGHT APPLIES TO THE NON-DIMMABLE VERSION. FOR THE DIMMABLE VERSIONS DIM OR DIM (TW) TUNABLE WHITE, A SURCHARGE WILL APPLY. TUNABLE WHITE IS AVAILABLE IN SELECTED COLLECTIONS ONLY.
THE COLLECTION IS AVAILABLE WITH TUNABLE WHITE, WHICH ALLOWS THE USER TO ADJUST THE COLOUR TEMPERATURE OF THE LIGHT SOURCE. THIS SOLUTION BEARS THE DESIGNATION DIM (TW). TUNABLE WHITE IS NOT AVAILABLE FOR DOUBLE FLOOR.

TECHNICAL DETAILS:

GLASS COLOUR

transparent glass (CGC23)
smoke grey - transparent glass (CGC516)
smoke brown - transparent glass (CGC538)
opaline - transparent glass (CGC38)
triplex opal (CGC39)

GLASS SURFACE

glossy surface (CGSU66)

BODY FINISH

metal - black matte powder coating with structure (CCS2673)

DIMMER CASE

black matte powder coating with structure (DC2939)
(PC1296, PC1297)

CANOPY

metal - black matte powder coating with structure (CCSC2674)

CABLE COLOUR

textile cable - black (CECL519)

LED SOURCE

DIM, 24V, LED, 9,4W, 2700K, 1064lm, RA90+ (LEDS2869)
(PC1293, PC1294, PC1295, PC1296, PC1297)
DIM (TW), 24V, LED, 9,4W, 2700K-6500K, 1064lm-1141lm, RA90+ (LEDS2940) (PC1293, PC1294, PC1295, PC1296)

DIMMABLE VERSION

non-dimmable version (CEDV1457) (PC1293, PC1294, PC1295)
DIM RF system - remote control version (CEDV1461) (PC1293, PC1294, PC1295)

DIM PWM signal (CEDV1459) (PC1293, PC1294, PC1295)
DIM 1-10V (CEDV1460) (PC1293, PC1294, PC1295)
DIM DALI version (CEDV1458) (PC1293, PC1294, PC1295)
DIM AC phase-cut (CEDV1730) (PC1293, PC1294, PC1295)
DIM CASAMBI CBU-PWM4 (CEDV2854) (PC1293, PC1294, PC1295)
DIM (TW) CASAMBI CBU-PWM4 (CEDV2942) (PC1293, PC1294, PC1295)
DIM (TW) DALI version (CEDV2944) (PC1293, PC1294, PC1295)

VOLTAGE/FREQUENCY

100-240 VAC, 50/60 Hz, 9,4W LED (PC1293, PC1294, PC1295, PC1296)
100-240 VAC, 50/60 Hz, 11W LED (PC1297)

[BACK TO INDEX](#)

Download:

- [WWW](#)
- [MORE INFO.](#)
- [PHOTOS](#)
- [INSTALLATION MANUAL](#)
- [DATASHEETS](#)
- [3DS](#)
- [DWG](#)
- [SKETCH UP](#)
- [LDT](#)

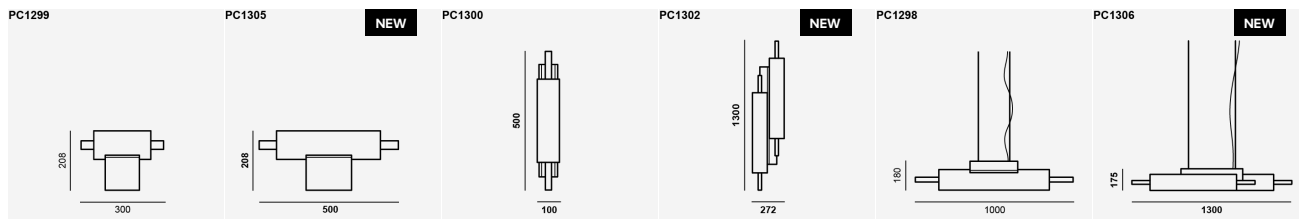

DOWNLOAD
SHARE

PC	PC1299	PC1305	PC1300	PC1302	PC1298	PC1306
NAME	TABLE S	TABLE M	WALL M	WALL L DOUBLE	PENDANT L	PENDANT L DOUBLE
PRICE A	1 296	1 356	1 933	3 834	2 556	3 594
PRICE B	-	-	-	-	-	-
PRICE C	-	-	-	-	-	-
SURCHARGES (NET)						
EXTRA CABLE UP TO 5M	-	-	-	-	+ 58	+ 58

IMPORTANT:

WITH REGARD TO THE DESIGN OF THE LIGHT, THE COMBINATIONS OF CONCRETE FIXTURE AND CABLE ARE STRICTLY PREDEFINED. THE WHITE FIXTURE IS ALWAYS COMBINED WITH A WHITE CABLE, THE NATURAL FIXTURE WITH A LIGHT GREY CABLE, AND THE ANTHRACITE FIXTURE WITH A DARK GREY CABLE.

TECHNICAL DETAILS:**GLASS COLOUR**

transparent glass (CGC23)
smoke grey - transparent glass (CGC516)
amber - transparent glass (CGC515)

GLASS SURFACE

glossy surface (CGSU66)
acid-etched outside surface (CGSU67)

BASE FINISH

High-performance concrete with glass fragments - white (CSFB2879)
High-performance concrete with glass fragments - natural (CSFB2880)

High-performance concrete with glass fragments - anthracite (CSFB2881)

CANOPY FINISH

High-performance concrete with glass fragments - white (CCSC2882)
High-performance concrete with glass fragments - natural (CCSC2883)
High-performance concrete with glass fragments - anthracite (CCSC2884)

CABLE COLOUR

textile cable - white (CECL521)
textile cable - light grey (CECL1918)

textile cable - dark grey (CECL520)

RECOMMENDED BULBS

1000 mm, 230V, LED, 8W, 2700K, 700 lm, RA90, DIM (CEB2900)
300 mm, 230V, LED, 6.2W, 2700K, 460 lm, RA90, DIM (CEB2898)
500 mm, 230V, LED, 6.2W, 2700K, 460 lm, RA90, DIM (CEB2899)

SOCKET

S14d

[BACK TO INDEX](#)

Download:

[WWW](#)[MORE INFO.](#)[PHOTOS](#)[INSTALATION MANUAL](#)[DATASHEETS](#)[3DS](#)[DWG](#)[SKETCH UP](#)[LDT](#)

IP20



FAQ

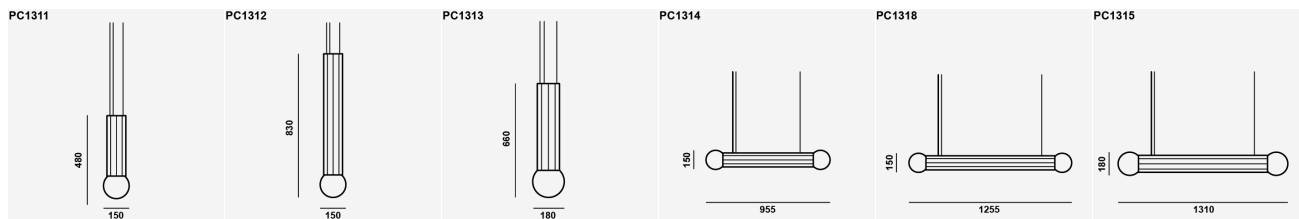

DOWNLOAD
SHARE

PC	PC1311	PC1312	PC1313	PC1314	PC1318	PC1315
NAME	PENDENT SINGLE SMALL 350	PENDENT SINGLE SMALL 700	PENDENT SINGLE LARGE 500	PENDENT DOUBLE SMALL 700	PENDENT DOUBLE SMALL 1000	PENDENT DOUBLE LARGE 1000
PRICE A	3 433	3 746	3 714	4 247	4 247	4 934
PRICE B	-	-	-	-	-	-
PRICE C	-	-	-	-	-	-
SURCHARGES (NET)						
EXTRA CABLE UP TO 5M	+ 58	+ 58	+ 58	+ 58	+ 58	+ 58
DIM	+ 54	+ 54	+ 54	+ 54	+ 54	+ 54

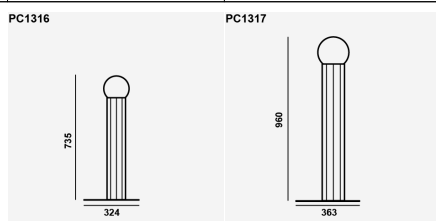

PC	PC1316	PC1317
NAME	FLOOR SMALL 600	FLOOR LARGE 800
PRICE A	3 556	3 772
PRICE B	-	-
PRICE C	-	-

IMPORTANT:

THE PRICE OF THE LIGHT APPLIES TO THE NON-DIMMABLE VERSION. FOR THE DIMMABLE VERSIONS DIM OR DIM (TW) TUNABLE WHITE, A SURCHARGE WILL APPLY. TUNABLE WHITE IS AVAILABLE IN SELECTED COLLECTIONS ONLY.

TECHNICAL DETAILS:**GLASS COLOUR**

transparent glass (CGC23)
smoke grey - transparent glass (CGC516)

GLASS SURFACE

glossy surface (CGSU66)

BODY FINISH

Yellow zinc lacquer (CCS2964)
Brushed steel lacquered (CCS2887)

CANOPY

Yellow zinc lacquer (CCSC2965)

Brushed steel lacquered (CCSC2888)

CABLE COLOUR

coaxial cable - silver (CECL2772) (PC1311, PC1312, PC1313, PC1314, PC1315, PC1318)
textile cable - light grey (CECL1918) (PC1316, PC1317)

LED SOURCE

24V, LED, 6W, 2700K, 683lm, RA90, DIM (LEDS2901) (PC1311, PC1312, PC1313, PC1314, PC1315, PC1318)
350mA, LED, 6.7W, 2700K, 939lm, RA90, DIM (LEDS2915) (PC1316, PC1317)

DIMMABLE VERSION

non-dimmable version (CEDV1457)
DIM RF system - remote control version (CEDV1461)
DIM PWM signal (CEDV1459)
DIM 1-10V (CEDV1460)
DIM DALI version (CEDV1458)
DIM AC phase-cut (CEDV1730)
DIM CASAMBI CBU-PWM4 (CEDV2854)

VOLTAGE/FREQUENCY

100-240 VAC, 50/60 Hz, 6W LED (PC1311, PC1312, PC1313)
100-240 VAC, 50/60 Hz, 6.7 W LED (PC1316, PC1317)
100-240 VAC, 50/60 Hz, 12W LED (PC1314, PC1315, PC1318)

[BACK TO INDEX](#)

Download:

[WWW](#)[MORE INFO.](#)[PHOTOS](#)[INSTALLATION MANUAL](#)[DATASHEETS](#)[3DS](#)[DWG](#)[SKETCH UP](#)[LDT](#)



DOWNLOAD
SHARE

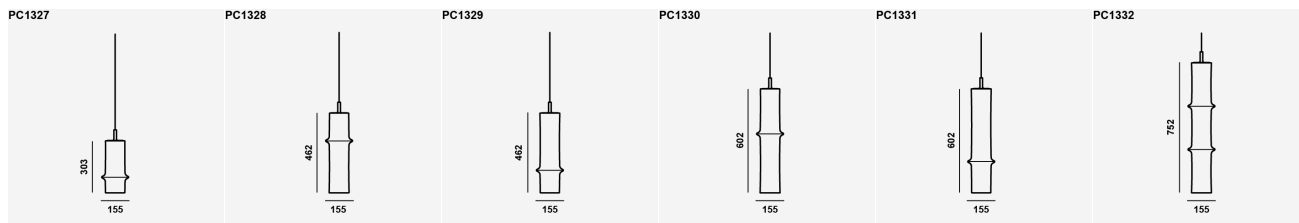

PC	PC1327	PC1328	PC1329	PC1330	PC1331	PC1332
NAME	S	M UP	M DOWN	L UP	L DOWN	XL DOUBLE
PRICE A	1 074	1 314	1 314	1 554	1 554	1 674
PRICE B	-	-	-	-	-	-
PRICE C	-	-	-	-	-	-
SURCHARGES (NET)						
EXTRA CABLE UP TO 5M	+ 36	+ 36	+ 36	+ 36	+ 36	+ 36
TRIMLESS	+ 120	+ 120	+ 120	+ 120	+ 120	+ 120
DIM	+ 54	+ 54	+ 54	+ 54	+ 54	+ 54
DIM (TW)	+ 78	+ 78	+ 78	+ 78	+ 78	+ 78

IMPORTANT:

THE PRICE OF THE LIGHT APPLIES TO THE NON-DIMMABLE VERSION. FOR THE DIMMABLE VERSIONS DIM OR DIM (TW) TUNABLE WHITE, A SURCHARGE WILL APPLY. TUNABLE WHITE IS AVAILABLE IN SELECTED COLLECTIONS ONLY.

THE COLLECTION IS AVAILABLE WITH TUNABLE WHITE, WHICH ALLOWS THE USER TO ADJUST THE COLOUR TEMPERATURE OF THE LIGHT SOURCE. THIS SOLUTION BEARS THE DESIGNATION DIM (TW).

IN ADDITION TO INDIVIDUAL LIGHTS, BAMBOO FOREST CAN ALSO BE ORDERED IN STANDARDIZED SETS, WHICH YOU CAN FIND BY CLICKING ON THE CONFIG ICON IN THE BOTTOM RIGHT CORNER OF THE PAGE. PRICING FOR THESE SETS IS AVAILABLE IN MY BROKIS.

TECHNICAL DETAILS:**GLASS COLOUR**

light smoke grey - transparent glass (CGC2932)
smoke brown - transparent glass (CGC538)
opaline - transparent glass (CGC38)

GLASS SURFACE

glossy surface (CGSU66)

BODY FINISH

black anodized (CCS1948)

CANOPY FINISH

metal - black matte powder coating with structure (CCSC2674)

Trimless – cable version – black structure (CCSC2904)

CONNECTION METHOD

BROKIS connector 24V (CCM1019)

CABLE COLOUR

textile cable - black (CECL519)

LED SOURCE

DIM, 24V, LED, 6.5W, 2700K, 735lm, RA90+ (LEDS2953)
DIM (TW), 24V, LED, 6.5W, 2700K-6500K, 735lm-789lm, RA90+ (LEDS2954)

DIMMABLE VERSION

non-dimmable version (CEDV1457)
DIM RF system - remote control version (CEDV1461)
DIM PWM signal (CEDV1459)
DIM 1-10V (CEDV1460)
DIM DALI version (CEDV1458)
DIM AC phase-cut (CEDV1730)
DIM CASAMBI CBU-PWM4 (CEDV2854)
DIM (TW) CASAMBI CBU-PWM4 (CEDV2942)
DIM (TW) DALI version (CEDV2944)

VOLTAGE/FREQUENCY

100-240 VAC, 50/60 Hz, 6.5W LED

[BACK TO INDEX](#)

Download:

[WWW](#)

[MORE INFO.](#)

[PHOTOS](#)

[INSTALLATION MANUAL](#)

[DATASHEETS](#)

[3DS](#)

[DWG](#)

[SKETCH UP](#)

[LDT](#)

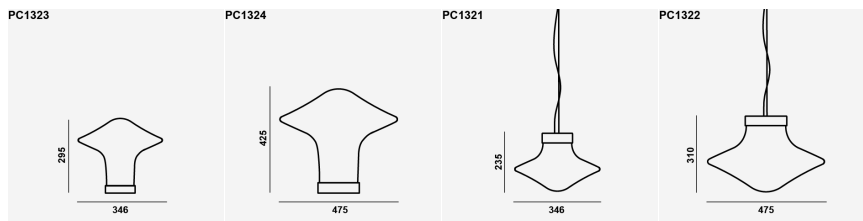

DOWNLOAD
SHARE

PC	PC1323	PC1324	PC1321	PC1322
NAME	TABLE S	TABLE L	PENDANT S	PENDANT L
PRICE A	1 980	2 388	1 788	2 148
PRICE B	-	-	-	-
PRICE C	-	-	-	-
SURCHARGES (NET)				
EXTRA CABLE UP TO 5M	-	-	+ 43	+ 43
DIM	-	-	+ 54	+ 54
DIM (TW)	-	-	+ 78	+ 78

IMPORTANT:

THE PRICE OF THE LIGHT APPLIES TO THE NON-DIMMABLE VERSION. FOR THE DIMMABLE VERSIONS DIM OR DIM (TW) TUNABLE WHITE, A SURCHARGE WILL APPLY. TUNABLE WHITE IS AVAILABLE IN SELECTED COLLECTIONS ONLY.
THE COLLECTION IS AVAILABLE WITH TUNABLE WHITE, WHICH ALLOWS THE USER TO ADJUST THE COLOUR TEMPERATURE OF THE LIGHT SOURCE. THIS SOLUTION BEARS THE DESIGNATION DIM (TW).

TECHNICAL DETAILS:**GLASS COLOUR**

opaline - transparent glass (CGC38)
pearl grey - opaline glass (CGC1916)

GLASS SURFACE

glossy surface (CGSU66)

BODY FINISH

silver anodized (CCS1917)
black anodized (CCS1948)

DIMMER CASE

black anodized (DC2937) (PC1323, PC1324)
silver anodized (DC2938) (PC1323, PC1324)

CANOPY FINISH

metal - white matte powder coating with structure (CCSC2810)

metal - black matte powder coating with structure (CCSC2674)

CONNECTION METHOD

BROKIS connector 24V (CCM1019) (PC1323, PC1324)

CABLE COLOUR

textile cable - black (CECL519)
textile cable - light grey (CECL1918)

LED SOURCE

DIM, 24V, LED, 9.4W, 2700K, 1064lm, RA90+ (LEDS2869) (PC1321, PC1323)
DIM (TW), 24V, LED, 9.4W, 2700K-6500K, 1064lm-1141lm, RA90+ (LEDS2940) (PC1321, PC1323)
DIM, 24V, LED, 10W, 2700K, 1261lm, RA90+ (LEDS2947) (PC1322, PC1324)
DIM (TW), 24V, LED, 10W, 2700K-6500K, 1261lm-1354lm,

RA90+ (LEDS2948) (PC1322, PC1324)

DIMMABLE VERSION

non-dimmable version (CEDV1457)
DIM RF system - remote control version (CEDV1461)
DIM PWM signal (CEDV1459)
DIM 1-10V (CEDV1460)
DIM DALI version (CEDV1458)
DIM AC phase-cut (CEDV1730)
DIM CASAMBI CBU-PWM4 (CEDV2854)
DIM (TW) CASAMBI CBU-PWM4 (CEDV2942)
DIM (TW) DALI version (CEDV2944)

VOLTAGE/FREQUENCY

100-240 VAC, 50/60 Hz, 12W LED (PC1322, PC1324)
100-240 VAC, 50/60 Hz, 11W LED (PC1321, PC1323)

[BACK TO INDEX](#)

Download:

[WWW](#)[MORE INFO.](#)[PHOTOS](#)[INSTALLATION MANUAL](#)[DATASHEETS](#)[3DS](#)[DWG](#)[SKETCH UP](#)[LDT](#)



DOWNLOAD
SHARE

PC1326

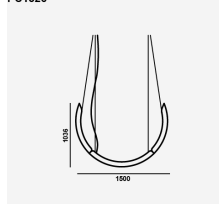

PC	PC1326
NAME	ELO
PRICE A	11 988
PRICE B	-
PRICE C	-
SURCHARGES (NET)	
EXTRA CABLE UP TO 5M	+ 58
DIM	+ 54
DIM (TW)	+ 78

IMPORTANT:

THE PRICE OF THE LIGHT APPLIES TO THE NON-DIMMABLE VERSION. FOR THE DIMMABLE VERSIONS DIM OR DIM (TW) TUNABLE WHITE, A SURCHARGE WILL APPLY. TUNABLE WHITE IS AVAILABLE IN SELECTED COLLECTIONS ONLY.

THE COLLECTION IS AVAILABLE WITH TUNABLE WHITE, WHICH ALLOWS THE USER TO ADJUST THE COLOUR TEMPERATURE OF THE LIGHT SOURCE. THIS SOLUTION BEARS THE DESIGNATION DIM (TW).

ELO COMPRISES THREE ARMS, THE OUTER TWO OF WHICH CAN BE POSITIONED TO CREATE IMPRESSIVE LIGHTING COMPOSITIONS.

TECHNICAL DETAILS:**GLASS COLOUR**

triplex opal BROKISGLASS (CGC2676)
smoke grey BROKISGLASS (CGC2677)

GLASS SURFACE

glossy finish (front face) (CGSU2736)
acid-etched finish (front face) (CGSU2737)

BODY FINISH

metal - black matte powder coating with structure (CCS2673)
sandblasted aluminium transparent powder coating (CCS2935)

CANOPY FINISH

metal - black matte powder coating with structure (CCSC2674)
sandblasted aluminium transparent powder coating (CCSC2934)

CABLE COLOUR

textile cable - black (CECL519)
textile cable - light grey (CECL1918)

LED SOURCE

DIM, 24V, LED, 140W, 2700K, lm, RA90+ (LEDS2955)
DIM (TW), 24V, LED, 140W, 2700K-6500K, RA90+ (LEDS2957)

DIMMABLE VERSION

non-dimmable version (CEDV1457)
DIM 1-10V (CEDV1460)
DIM DALI version (CEDV1458)
DIM (TW) DALI version (CEDV2944)

VOLTAGE/FREQUENCY

100-240 VAC, 50/60Hz, 140W LED

[BACK TO INDEX](#)

Download:

[WWW](#)
[MORE INFO.](#)
[PHOTOS](#)
[INSTALLATION MANUAL](#)
[DATASHEETS](#)
[3DS](#)
[DWG](#)
[SKETCH UP](#)
[LDT](#)

PENDENT LIGHTS CABLE LENGTHS AND SURCHARGES

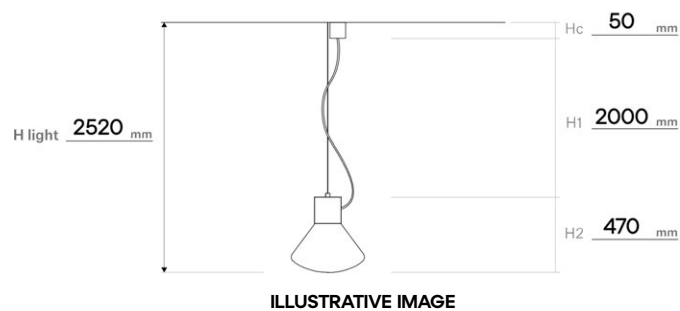
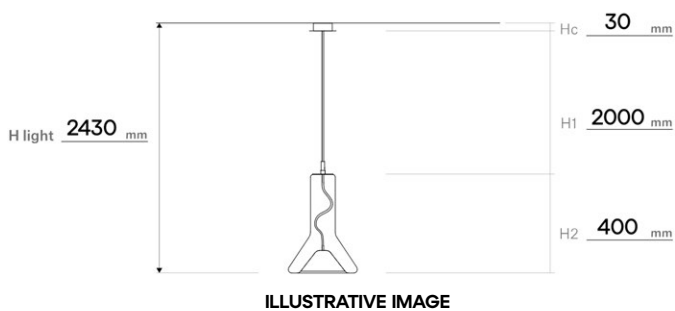

A standard length of electrical cable or steel wire is included in the price of the pendant. The standard length is depicted as H1. Hc length is an additional length added to the standard length. H1 and Hc lengths for specific pendant lights can be found at www.mybrokis.cz. The extra charge for cable length up to 5m is shown in the following table. The price for extra length is net and is added to the price of the light after discount. Lengths over 5m must be consulted and priced individually by BROKIS.

FAMILY	PC	STANDARD LENGTH IN CM (H1)	EXTRA CABLE UP TO 5M (NET)
MUFFINS	PC986, PC865, PC851	200	43
SHADOWS	PC894, PC895, PC896, PC897	200	36
SHADOWS	PC891, PC929, PC931	200	144
SHADOWS	PC921	200	288
SHADOWS XL	PC911, PC939, PC940, PC976	200	36
SHADOWS XL	PC1000	200	144
SHADOWS EXTERIOR	PC1160, PC1161, PC1162, PC1163	200	36
CAPSULA	PC937	200	58
CAPSULA	PC943	200	173
CAPSULA	PC966	200	288
WHISTLE	PC952, PC953	200	36
WHISTLE	PC961	200	101
FLUTES	PC956, PC977, PC978	200	36
NIGHT BIRDS	PC962, PC963, PC964	200	36
NIGHT BIRDS EXTERIOR	PC1111, PC1112, PC1113	200	36
PURO SOLO	PC1155, PC1122, PC1123, PC1124	200	36
PURO SOLO	PC1156, PC1125, PC1126, PC1127	200	72
PURO SINGLE	PC1157, PC1013, PC1014, PC1015, PC1121	200	36
PURO SINGLE	PC1158, PC1010, PC1011, PC1012	200	72
PURO ECLECTIC	PC1114, PC1115	200	130
PURO CONTOUR	PC1133, PC1118	200	130
PURO CONTOUR	PC1057, PC1073	200	173
PURO CONTOUR	PC1135, PC1119	200	216
PURO CONTOUR	PC1137, PC1120	200	259

[BACK TO INDEX](#)

CONTACT:

tel.: +420 567 211 517
email: info@brokis.cz

BROKIS
Španielova 1315/25, Praha 6, 163 00
Czech Republic

ID: 64940799
VAT: CZ64940799

www.brokis.cz

PENDENT LIGHTS CABLE LENGTHS AND SURCHARGES

FAMILY	PC	STANDARD LENGTH IN CM (H1)	EXTRA CABLE UP TO 5M (NET)
PURO CONTOUR	PC1137, PC1120	200	259
PURO SPARKLE	PC1053, PC1054, PC1055	200	360
JACK O'LANTERN SMALL	PC1101, PC1103, PC1104	200	43
JACK O'LANTERN LARGE	PC1082	200	43
BIG ONE	PC1335, PC1336	200	58
IVY VERTICAL	PC1059, PC1060, PC1061, PC1062, PC1063, PC1064	200	58
IVY HORIZONTAL	PC1065, PC1066, PC1067, PC1068, PC1069, PC1070	200	58
IVY SINGLE	PC1215, PC1216, PC1217	200	36
AWA	PC1129, PC1130	200	36
SFERA	PC1168, PC1285, PC1286, PC1246, PC1247, PC1169, PC1170, PC1171, PC1172, PC1284	200	36
GEOMETRIC LIGHT	PC1140, PC1141, PC1142, PC1143, PC1144, PC1145, PC1146, PC1147, PC1150	200	58
ORBIS	PC1289, PC1290, PC1291	200	36
DOUBLE	PC1293, PC1294, PC1295	200	43
OVERLAY	PC1298, PC1306	200	58
PRISMA	PC1311, PC1312, PC1313, PC1314, PC1318, PC1315	200	58
BAMBOO FOREST	PC1327, PC1328, PC1329, PC1330, PC1331, PC1332	200	36
TROTTOLA	PC1321, PC1322	200	43
ELO	PC1326	200	58

[BACK TO INDEX](#)

CONTACT:

tel.: +420 567 211 517
email: info@brokis.cz

BROKIS
Španielova 1315/25, Praha 6, 163 00
Czech Republic

ID: 64940799
VAT: CZ64940799

www.brokis.cz

PENDENT LIGHTS CABLE LENGTHS AND SURCHARGES

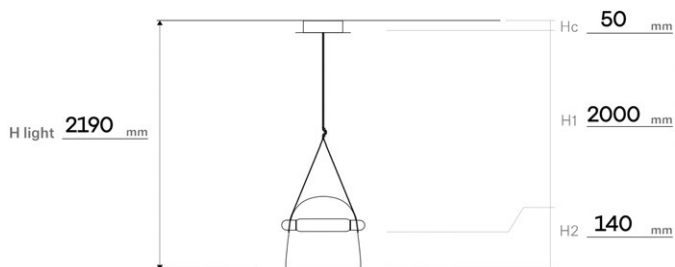

ILLUSTRATIVE IMAGE

A standard length of leather strap is included in the price of the pendant. The standard length is depicted as H1. Hc length is an additional length added to the standard length. H1 and Hc lengths for specific pendant lights can be found at www.mybrokis.cz. The extra charge for 1m of strap is shown in the following table. The price for extra length is net and is added to the price of the light after discount. Lengths over 5m must be consulted and priced individually by BROKIS.

FAMILY	PC	STANDARD LENGTH IN CM (H1)	STRAPS FOR 1M EXTRA (NET)
MONA MEDIUM	PC979 - MEDIUM PENDENT	200	100
MONA LARGE	PC938 - LARGE PENDENT	200	113
MONA XL	PC1030 - XL PENDENT	200	130

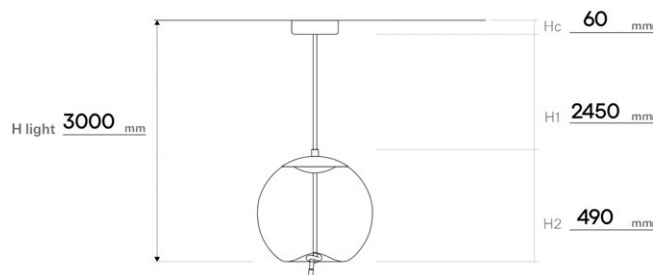

ILLUSTRATIVE IMAGE

A standard length of rope is included in the price of the pendant. The standard length is depicted as H1. Hc length is an additional length added to the standard length. H1 and Hc lengths for specific pendant lights can be found at www.mybrokis.cz. The extra charge for 1m of rope is shown in the following table. The price for extra length is net and is added to the price of the light after discount. Lengths over 5m must be consulted and priced individually by BROKIS.

FAMILY	PC	STANDARD LENGTH IN CM (H1)	ROPE FOR 1M EXTRA (NET)
KNOT SMALL	PC1035 - SMALL SFERA	264	86
KNOT SMALL	PC1037 - SMALL DISCO	279,5	86
KNOT SMALL	PC1036 - SMALL UOVO	265	86
KNOT SMALL	PC1034 - SMALL CILINDRO	266	86
KNOT	PC1016 - SFERA	245	108
KNOT	PC1017 - DISCO	270,5	108
KNOT	PC1018 - UOVO	246	108
KNOT	PC1019 - CILINDRO	248	108

[BACK TO INDEX](#)

CONTACT:

tel.: +420 567 211 517
email: info@brokis.cz

BROKIS
Španielova 1315/25, Praha 6, 163 00
Czech Republic

ID: 64940799
VAT: CZ64940799

www.brokis.cz

CLEANING BROKIS LIGHTS

As with all products, BROKIS lights require periodic cleaning. Dust, grease, and film affect the visual quality of any item made of glass.

It is in the interest of the user to maintain the singular appearance of the lights.

This can only be achieved through regular cleaning. When neglected, the cleaning process becomes unnecessarily time consuming. The cleaning interval depends on the environment the lights are installed in and is primarily influenced by humidity levels, temperature stability, and the amount of dust in the air.

BROKIS applies the highest possible quality standards in manufacturing its lights.

Prior to shipping, each light undergoes several quality controls and stages of cleaning. Lights may require additional cleaning as a result of transportation, storage, and the amount of time that passes between packing and subsequent unpacking by the client. Therefore, we recommend cleaning the lights prior to installation.

RECOMMENDED CLEANING METHODS

When cleaning lights from any of our collections, we recommend first disassembling them according to the instructions in the installation manual and then securing the glass components against mechanical damage.

The glass must first be rinsed in hot water and a dilution of dish detergent to remove all foreign particles and dust. Repeat this process if necessary. The glass must then be cleaned a second time using hot water and a dilution of degreaser (such as ammonia or vinegar) and thoroughly rinsed under running hot water. Repeat this process if necessary. Next, dry the glass thoroughly with a paper or a soft cotton towel. Only reassemble the light once the glass has cooled completely.

Do not use mineral spirits, highly concentrated thinners, or other substances not intended for use on glass surfaces. Do not use products containing silicone, since they quickly attract more dust and grease.

cleaning information and
unpacking the box

[BACK TO INDEX](#)**CONTACT:**

tel.: +420 567 211 517
email: info@brokis.cz

BROKIS
Španielova 1315/25, Praha 6, 163 00
Czech Republic

ID: 64940799
VAT: CZ64940799

www.brokis.cz

BROKIS
WEBSITE



MY
BROKIS



VIRTUAL
PROJECTS



PROMO
VIDEO



BROKIS
PROJECTS



PR KIT



BROKIS
CATALOGUES



TECHNICAL INFORMATION
ABOUT PRODUCTS



cleaning information
and unpacking the box



technical
information



product
registration

SOCIAL MEDIA



BROKISGLASS



ARCHI
TONIC



archiproducts



archilovers

